



US Army Corps
of Engineers®
Seattle District



Skagit River Flood Risk Management General Investigation

Skagit County, Washington

Draft Feasibility Report and
Environmental Impact Statement

Appendix E – Geotechnical Appendix

May 2014

1. GEOTECHNICAL ENGINEERING SUMMARY

1.1 Dimensions and Volumes Determination

Top of levee elevations and profiles were obtained from the Seattle District National Levee Database (NLD) levee centerline data, surveyed by Woolpert in 2010 and provided to USACE. Typical levee sections, dimensions, widths, and slopes were obtained in part from sections surveyed by Woolpert as part of the same task, but were primarily obtained from the NWS Survey of Levee Profiles and Sections 2009.04 (see attachments below). This NWS Survey effort was conducted for the Skagit River General Investigation project.

Typical sections for the levee raise are attached, as well as a summary of material quantities and detailed calculations from all design flows considered. Water surface elevations (WSE, attached) were compared against existing levee top elevations to determine the height of levee raise required section-by-section.

Preliminary estimates of material quantities for the two bypass alternatives, as well as their corresponding maps, are also attached.

1.2 Levee Risk and Reliability

Levee Risk and Reliability analysis was performed by Shannon & Wilson for USACE, as part of the Skagit River GI project, with completed reports submitted January 31, 2011. This information helped to determine 15% and 85% Probable Non-Failure Points (PNP) and Probable Failure Points (PFP), respectively, for the levees along the Skagit River at various locations. Eight such locations were analyzed, as determined by each Skagit County Dike District. The 15% and 85% points were provided in the form of a water surface elevation below top of levee that corresponds to 15% and 85% likelihood of failure. The 15% point corresponds to a very low likelihood of failure (non-failure), while the 85% point corresponds to a likely failure, when the river reaches that elevation at that section. The locations of the analyzed sections appear in the Shannon & Wilson Risk and Reliability Report (attached).

Because only eight (8) sections were analyzed, these conditions were extrapolated and applied throughout the levee systems on the Skagit River. Due to this strategy, preliminary estimates may result in more severe conditions than truly exist throughout the levee systems.

1.3 Subsurface Conditions

Historically, hundreds of soil borings have been performed along the Skagit River levee system. Recently, both Shannon & Wilson and Golder Associates performed additional borings in support of their respective analyses. Newer borings reflected similar conditions to those performed in the past decades. A combination of this soil boring information can be utilized. Boring logs prepared by Shannon & Wilson are present in the attached report. No other subsurface information is attached to this appendix.

2. ATTACHMENTS

- Typical Section – Levee Raise configuration, Figure 8-6 EM 1110-2-1913
- Typical Section – Levee Raise features, dimensions, and detail
- Comprehensive Urban Levee Improvement Alternative Map 2014.01.10
- Levee Raise Dimensions and Quantities – Summary of 75-, 100-, and 250-year
- Levee Raise Dimensions and Quantities – 75-year
- Levee Raise Dimensions and Quantities – 100-year
- Levee Raise Dimensions and Quantities – 250-year
- Levee Raise Dimensions and Quantities – Assumptions
- NWS Survey of Levee Profiles and Sections 2009.04
- Water Surface Elevations for 75-, 100-, and 250-year Flows
- Water Surface Elevations Graph of 75-, 100-, and 250-year Profiles
- Joe Leary Slough Bypass Alternative Map 2014.01.10
- Joe Leary Slough Bypass Dimensions and Quantities Preliminary 100-year
- Swinomish Bypass Alternative Map 2014.01.10
- Swinomish Bypass Dimensions and Quantities Preliminary 100-year
- Mount Vernon Downtown Flood Protection Floodwall Design Drawings 2009.01.30
- Shannon & Wilson Levee Risk and Reliability Report 2011.01.31

RIVERSIDE

LANDSIDE

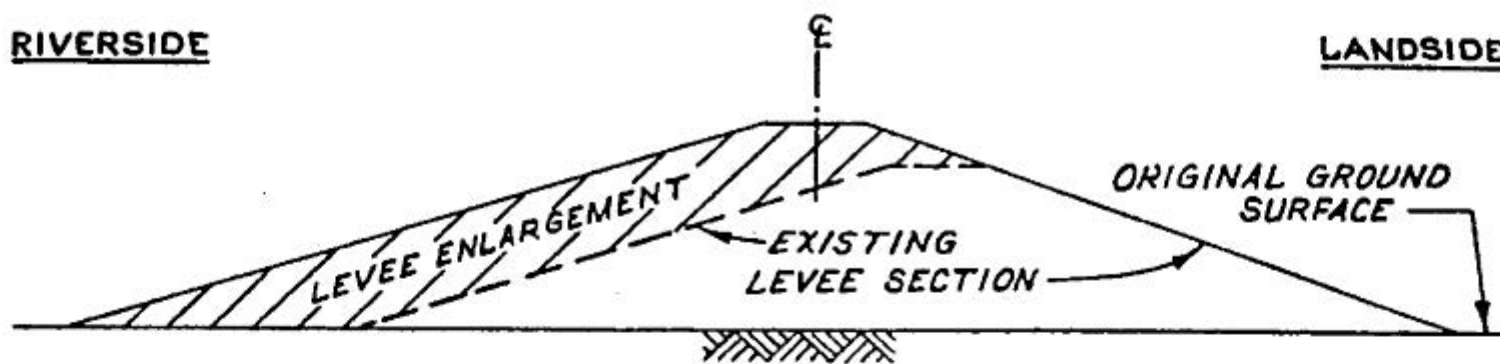

a. Riverside levee enlargement

RIVERSIDE

LANDSIDE

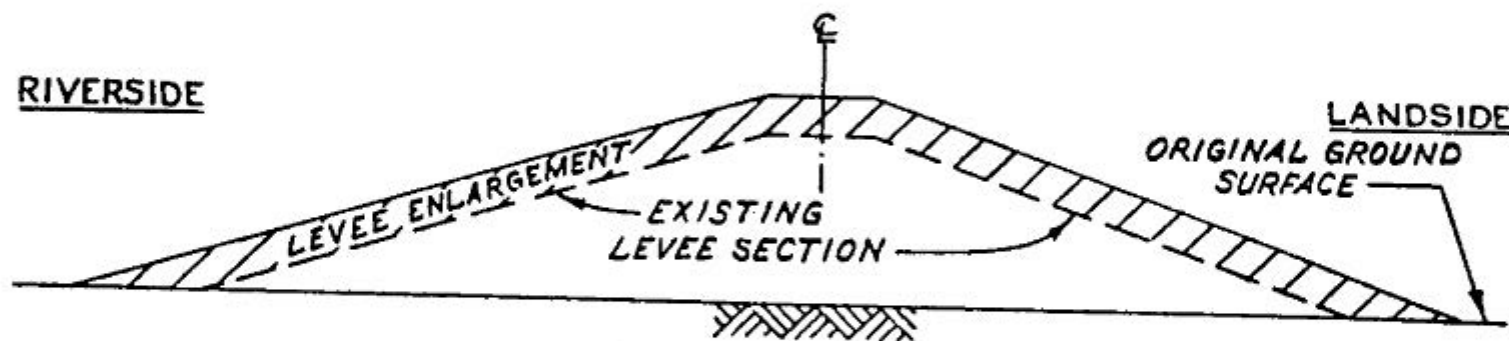

b. Straddle levee enlargement

RIVERSIDE

LANDSIDE

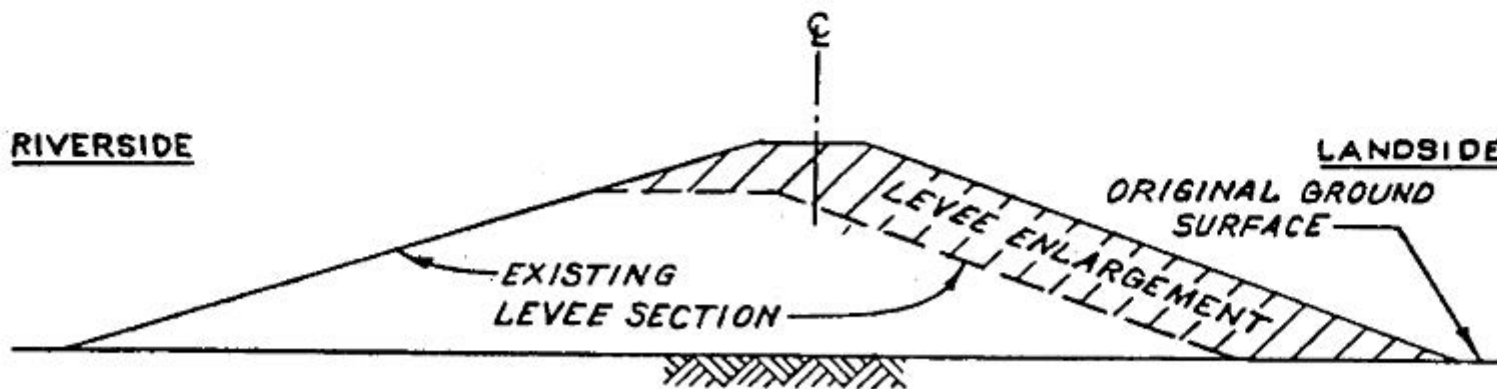

c. Landside levee enlargement

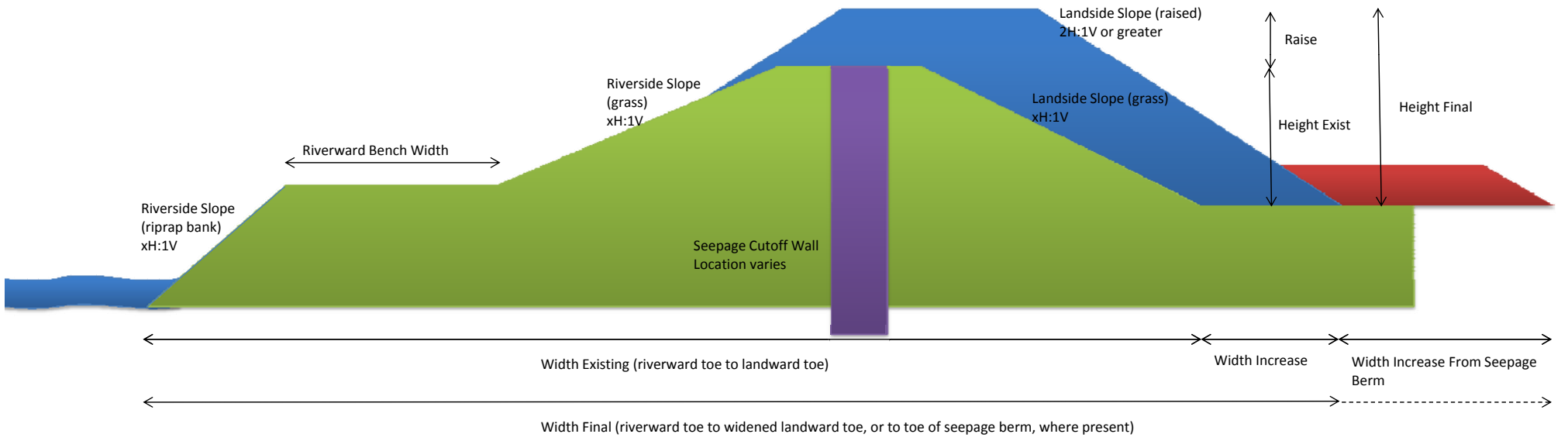



10 JAN 2014

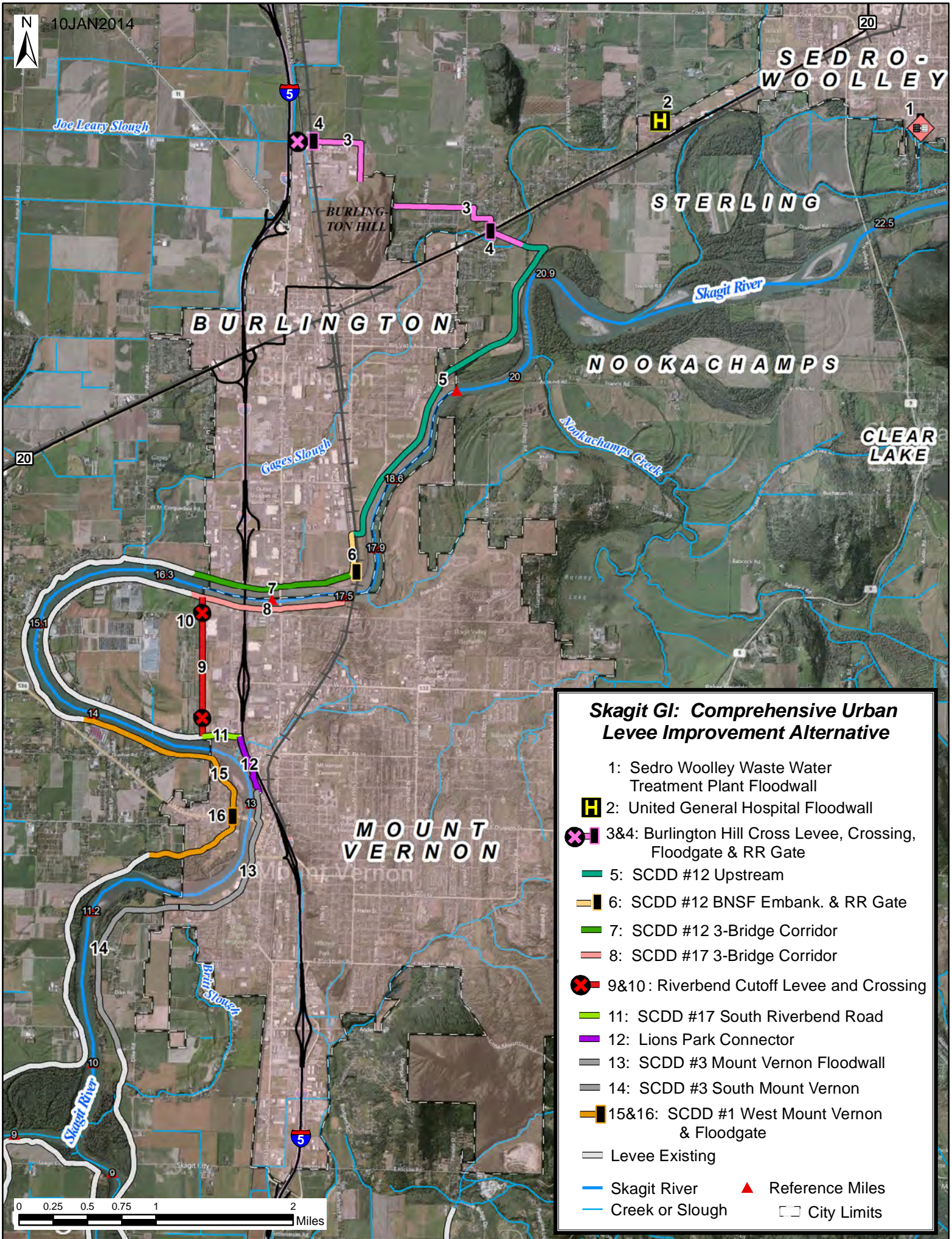

Skagit GI: Comprehensive Urban Levee Improvement Alternative

- 1: Sedro Woolley Waste Water Treatment Plant Floodwall
- H** 2: United General Hospital Floodwall
- X** 3&4: Burlington Hill Cross Levee, Crossing, Floodgate & RR Gate
- 5**: SCDD #12 Upstream
- 6**: SCDD #12 BNSF Embank. & RR Gate
- 7**: SCDD #12 3-Bridge Corridor
- 8**: SCDD #17 3-Bridge Corridor
- X** 9&10: Riverbend Cutoff Levee and Crossing
- 11**: SCDD #17 South Riverbend Road
- 12**: Lions Park Connector
- 13**: SCDD #3 Mount Vernon Floodwall
- 14**: SCDD #3 South Mount Vernon
- 15&16**: SCDD #1 West Mount Vernon & Floodgate
- Levee Existing
- Skagit River
- Creek or Slough
- ▲** Reference Miles
- City Limits

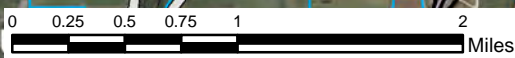

This sheet provides summary information from the Comprehensive Urban Levee Improvement Alternative under three design flows: 75-, 100- and 250-year

Updated: 11-Sep-13

75-year Value Summary

LEVEE RAISES ONLY		
ITEM	VALUE	UNIT
Length of Levee Raise	9.2	Miles
Total Volume of Soil (Raise)	379,629	YD ³
Total Volume of Soil (seepage berm)	315,024	YD ³
Total Volume of Gravel	15,619	YD ³
Total Land Area Required for Raise	74.1	Acres
Average Raise Amount	2.0	Feet
Average Final Height	11.0	Feet
Average Width Increase (excl. berm)	16.0	Feet

BURLINGTON HILL CROSS LEVEE

ITEM	VALUE	UNIT
Length of New Levee	1.9	Miles
Total Volume of Soil	65,000	YD ³
Total Volume of Gravel	2,245	YD ³
Total Land Area Required	16.7	Acres

RIVERBEND CUTOFF LEVEE

ITEM	VALUE	UNIT
Length of New Levee	1.0	Miles
Total Volume of Soil	188,444	YD ³
Total Volume of Gravel	1,178	YD ³
Total Land Area Required	16.8	Acres

100-year Value Summary

LEVEE RAISES ONLY		
ITEM	VALUE	UNIT
Length of Levee Raise	9.2	Miles
Total Volume of Soil (Raise)	480,824	YD ³
Total Volume of Soil (Seepage)	294,769	YD ³
Total Volume of Gravel	15,619	YD ³
Total Land Area Required for Raise	75.6	Acres
Average Raise Amount	2.4	Feet
Average Final Height	11.4	Feet
Average Width Increase (excl. berm)	18.6	Feet

BURLINGTON HILL CROSS LEVEE

ITEM	VALUE	UNIT
Length of New Levee	1.9	Miles
Total Volume of Soil	81,767	YD ³
Total Volume of Gravel	2,245	YD ³
Total Land Area Required	18.0	Acres

RIVERBEND CUTOFF LEVEE

ITEM	VALUE	UNIT
Length of New Levee	1.0	Miles
Total Volume of Soil	199,192	YD ³
Total Volume of Gravel	1,178	YD ³
Total Land Area Required	17.2	Acres

250-year Value Summary

LEVEE RAISES ONLY		
ITEM	VALUE	UNIT
Length of Levee Raise	9.2	Miles
Total Volume of Soil (Raise)	632,058	YD ³
Total Volume of Soil (Seepage)	264,419	YD ³
Total Volume of Gravel	15,619	YD ³
Total Land Area Required for Raise	77.5	Acres
Average Raise Amount	2.8	Feet
Average Final Height	11.8	Feet
Average Width Increase (excl. berm)	21.9	Feet

BURLINGTON HILL CROSS LEVEE

ITEM	VALUE	UNIT
Length of New Levee	1.9	Miles
Total Volume of Soil	106,088	YD ³
Total Volume of Gravel	2,245	YD ³
Total Land Area Required	19.8	Acres

RIVERBEND CUTOFF LEVEE

ITEM	VALUE	UNIT
Length of New Levee	1.0	Miles
Total Volume of Soil	212,477	YD ³
Total Volume of Gravel	1,178	YD ³
Total Land Area Required	17.6	Acres

LEGEND
Orange = Raised Levees
Pink = New Levees
Light Brown = AVERAGE or SUM Total
White = No Actions Taken

CONVERSIONS
yd^3 to ft^3
acre to ft^2

100-year Flood Frequency Levee Modifications and Dimensions

Main data table with columns: LOCATION AND INFORMATION, EXISTING DIMENSIONS, RAISE DIMENSIONS, WIDTHS, VOLUMES. Includes detailed rows for various districts and sections with their respective dimensions and volumes.

LEEVE RAISE ASSUMPTIONS

- * All levee raises will be made in the landward direction wherever possible. There may be situations where riverward widening is necessary. This is NOT a movement of the riprap toe - widening would be placed on bench.
- * SCDD 12 is already applying for permits to raise their levee by **4 feet, widening it by 60 feet**, from **Gardner Road** to the upstream terminus at **Lafayette Road**. This action matches with our initial estimates of levee raise and widening + seepage berm. Rather than include a seepage berm, the raise + berm distance will be set to 60 feet for simplified effort. This was accomplished in the spreadsheet by making the Seepage Berm Width = 60 - Raised Width
- * Where widening levees on the landward slope, a minimum slope angle of 3H:1V is assumed. For example, if the existing slope is 1.5H:1V, it will be graded to 3H:1V when raised. If the slope was already 3 or greater, it will be raised at the existing grade.
- * A seepage berm of width 30 feet is included in some areas for underseepage control. A seepage cutoff trench is another option that would require less real estate. Driven sheetpile is another option that doesn't take real estate.
- * Buffers drawn in GIS are based on the average condition for each Dike District, with the exception of DD12, which, due to its many irregularities, was split into 3 sections: 1) SCDD #12 Upstream; 2) SCDD #12 BNSF embankment; 3) SCDD #12 3-Bridge Corridor.
- * The Levee Reliability Failure Points are based on an analysis by Shannon & Wilson, 2009. The predominant failure mode is underseepage through the sandy overbank layer. By raising levees, the design Water Surface Elevation will be higher than the existing condition that was used in the analysis. This will cause the driving head for seepage to increase, having the effect of increasing the seepage potential. Raising the levees also includes widening them, which will in turn help reduce the seepage potential. As an additional measure for this Alternative Phase, an additional 30-foot seepage berm is assumed in most locations of levee raises to help mitigate the seepage concern. Seepage berms are not the only possible anti-seepage measure; cutoff walls can be constructed underground or sheetpiles driven into the foundation.



**US Army Corps
of Engineers
Seattle District**

SKAGIT COUNTY G I STUDY SKAGIT COUNTY, WASHINGTON

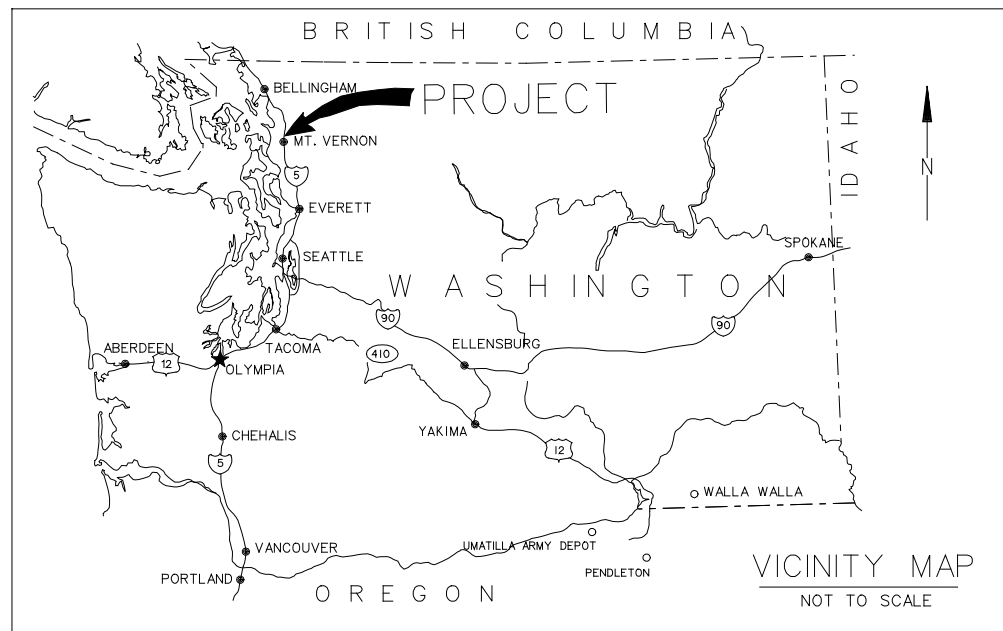

Approved by
RONALD M. BUSH, P.E.
CHIEF, TECHNICAL SERVICES BRANCH
Date
E-56-5-56
15 APR 09

Recommended by
GUY L. GREEN, P.E.
CHIEF, DESIGN BRANCH
Approved by
MARK A. OHLSTROM, P.E.
CHIEF, ENG. AND CONST. DIV

Submitted by
MAMIE S. BROUWER
DESIGN MANAGER
Reviewed by
DENNIS SCALF, P.E.
CH, TECH ENG AND REVIEW SEC

U.S. ARMY ENGINEER DISTRICT, SEATTLE
CORPS OF ENGINEERS
SEATTLE, WASHINGTON
Prepared by
DANIEL M. KATZ, P.E.
CH, HYDRAULICS & HYDROLOGY SEC

SKAGIT COUNTY G I STUDY
TITLE
AND VICINITY MAP
SKAGIT COUNTY
WASHINGTON

Plate
number:
G-001
Sheet 1 of 43

SAFETY FIRST

D

C

B

A

DRAWING INDEX		
SHEET NO.	PLATE NO.	TITLE
GENERAL		
1	G-001	TITLE AND VICINITY MAP
2	G-002	DRAWING INDEX
3	G-003	GI STUDY SITE MAP
DIKING DISTRICT #1		
4	1G-1	DIKING DISTRICT *1 SITE LOCATIONS & PROFILE DIFFERENTIAL
5	1G-2	DIKING DISTRICT *1 SITE LOCATIONS & PROFILE DIFFERENTIAL
6	1G-3	DIKING DISTRICT *1 SITE LOCATIONS & PROFILE DIFFERENTIAL
7	1C-1	CROSS SECTIONS 1-1 THRU 1-4
8	1C-2	CROSS SECTIONS 1-5 THRU 1-8
9	1C-3	CROSS SECTIONS 1-9 THRU 1-15
10	1C-4	CROSS SECTIONS 1-16 THRU 1-20
11	1C-5	CROSS SECTIONS 1-21 THRU 1-28
12	1C-6	CROSS SECTIONS 1-29 THRU 1-32
13	1C-7	CROSS SECTIONS 1-33 THRU 1-38
14	1C-8	CROSS SECTIONS 1-39 THRU 1-42
15	1C-9	CROSS SECTIONS 1-43 THRU 1-45
DIKING DISTRICT #3		
16	3G-1	DIKING DISTRICT *3 SITE LOCATIONS & PROFILE DIFFERENTIAL
17	3G-2	DIKING DISTRICT *3 SITE LOCATIONS & PROFILE DIFFERENTIAL
18	3G-3	DIKING DISTRICT *3 SITE LOCATIONS & PROFILE DIFFERENTIAL
19	3C-1	CROSS SECTIONS 3-1 THRU 3-4
20	3C-2	CROSS SECTIONS 3-5 THRU 3-8
21	3C-3	CROSS SECTIONS 3-9 THRU 3-12
22	3C-4	CROSS SECTIONS 3-13 THRU 3-18
23	3C-5	CROSS SECTIONS 3-19 THRU 3-24
24	3C-6	CROSS SECTIONS 3-25 THRU 3-29
25	3C-7	CROSS SECTIONS 3-30 THRU 3-35
26	3C-8	CROSS SECTIONS 3-36 THRU 3-44
DIKING DISTRICT #17		
27	17G-1	DIKING DISTRICT *17 SITE LOCATIONS & PROFILE DIFFERENTIAL
28	17C-1	CROSS SECTIONS 17-1 THRU 17-5
29	17C-2	CROSS SECTIONS 17-6 THRU 17-8
30	17C-3	CROSS SECTIONS 17-9 THRU 17-12
31	17C-4	CROSS SECTIONS 17-13 THRU 17-16
32	17C-5	CROSS SECTIONS 17-17 THRU 17-20
33	17C-6	CROSS SECTIONS 17-21 THRU 17-24
DIKING DISTRICT #22		
34	22G-1	DIKING DISTRICT *22 SITE LOCATIONS & PROFILE DIFFERENTIAL
35	22G-2	DIKING DISTRICT *22 SITE LOCATIONS & PROFILE DIFFERENTIAL
36	22C-1	CROSS SECTIONS 22-1 THRU 22-9
37	22C-2	CROSS SECTIONS 22-10 THRU 22-18
38	22C-3	CROSS SECTIONS 22-19 THRU 22-26
39	22C-4	CROSS SECTIONS 22-27 THRU 22-34
40	22C-5	CROSS SECTIONS 22-39 THRU 22-41
41	22C-6	CROSS SECTIONS 22-42 THRU 22-50
42	22C-7	CROSS SECTIONS 22-51 THRU 22-57
43	22C-8	CROSS SECTIONS 22-58 THRU 22-63



Symbol	Date	Description

U.S. ARMY ENGINEER DISTRICT, SEATTLE CORPS OF ENGINEERS SEATTLE, WASHINGTON Prepared by:	Designed by: J. BARRETT	Date: 1 APR 2009
	Drawn by: J. SKRINDE Checked by: X	File: X Rev.:

SKAGIT COUNTY GI STUDY
DRAWING INDEX
 SKAGIT COUNTY WASHINGTON

Plate number:
G-002
 Sheet 2 of 43

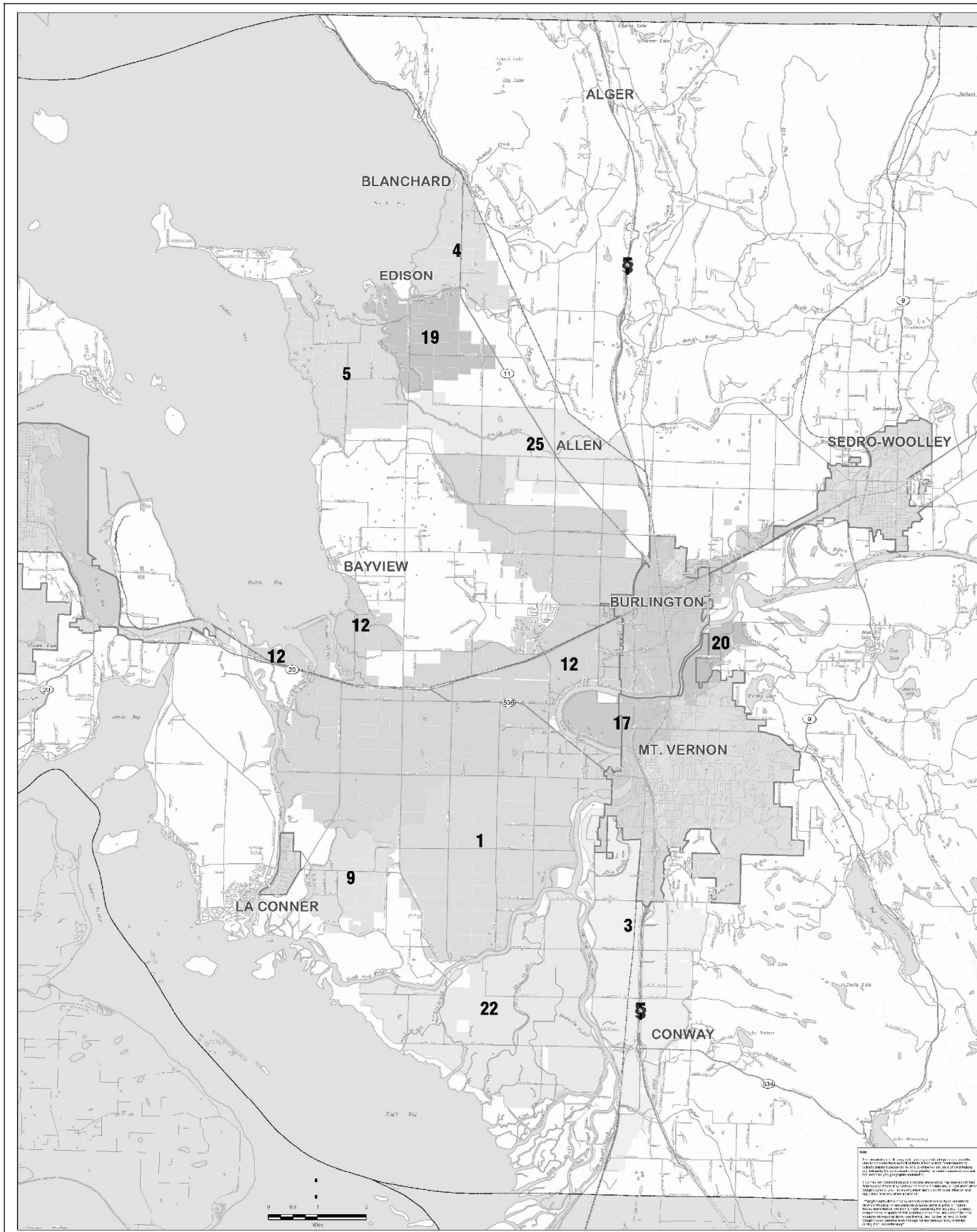

DIKE DISTRICT ASSESSMENT AREAS OF SKAGIT COUNTY

DIKE DISTRICT 1	DIKE DISTRICT 6	DIKE DISTRICT 17	DIKE DISTRICT 22
DIKE DISTRICT 3	DIKE DISTRICT 9	DIKE DISTRICT 19	DIKE DISTRICT 25
DIKE DISTRICT 4	DIKE DISTRICT 12	DIKE DISTRICT 20	
Dike and Levee System			

Legend

Map Title: Skagit County
Scale: 1:50,000

GI STUDY SITE MAP
NOT TO SCALE



Symbol	Description	Date	Appr.	Symbol	Description

U.S. ARMY ENGINEER DISTRICT, SEATTLE CORPS OF ENGINEERS SEATTLE, WASHINGTON Prepared by:	Designed by: J. BARRETT	Date: 1 APR 2009	
	Drawn by: J. SKRINDE	File: X	Rev.: X
	Checked by: X		

SKAGIT COUNTY GI STUDY
GI STUDY SITE MAP
SKAGIT COUNTY WASHINGTON

Plate number:
G-003
Sheet 3 of 43

D
C
B
A

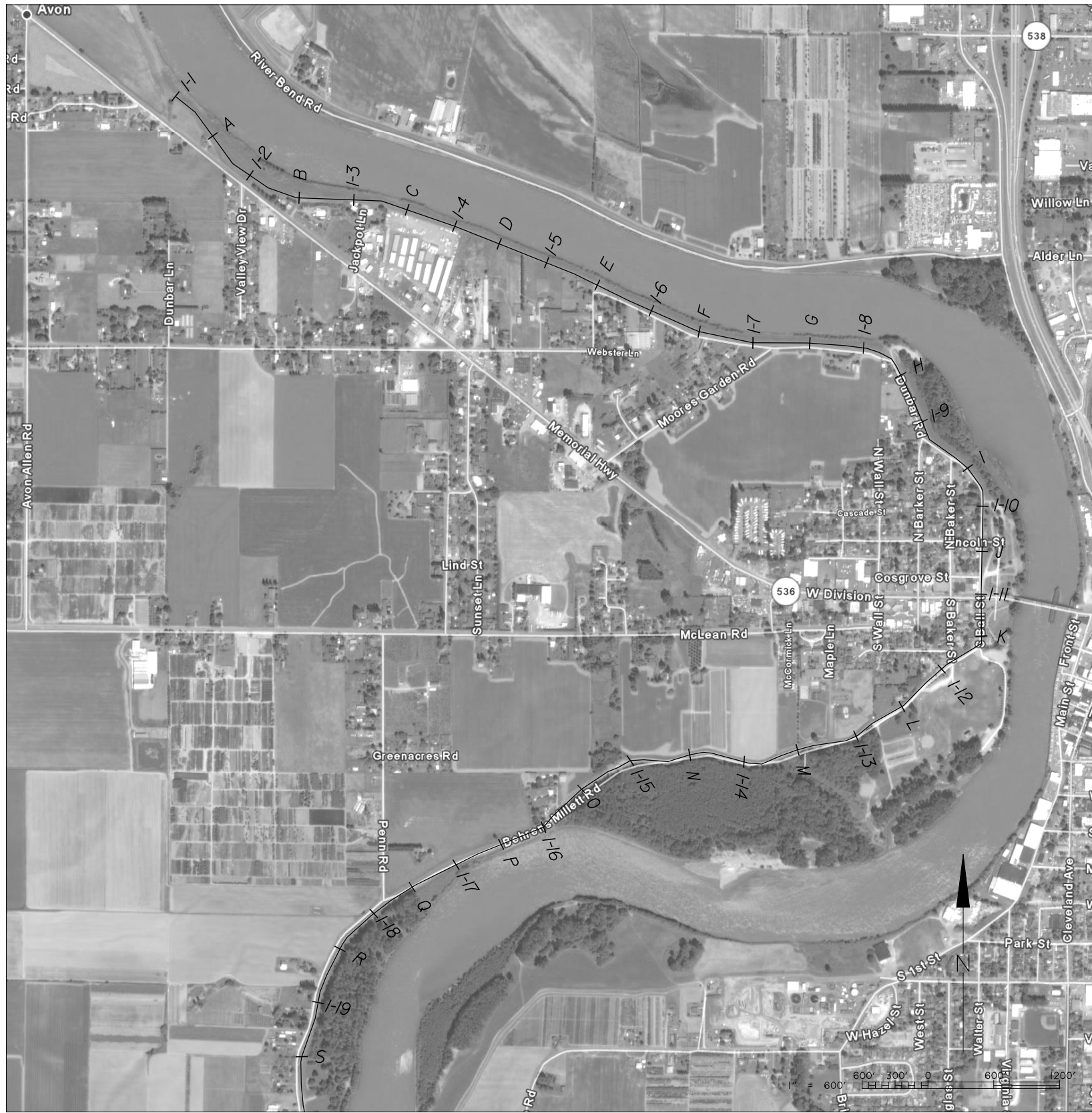

SITE LOCATIONS

1"=600'

PROFILE DIFFERENTIAL

STATION	DIFFERENCE +/-	STATION	DIFFERENCE +/-	STATION	DIFFERENCE +/-	STATION	DIFFERENCE +/-
1-1	0	D	-0.30	1-8	-1.50	K	-0.36
A	-0.41	1-5	-0.06	H	+0.20	1-12	-0.08
1-2	-0.26	E	-0.02	1-9	+0.05	L	+0.10
B	-1.10	1-6	-0.15	I	-0.18	1-13	-0.97
1-3	0	F	-0.48	1-10	+0.95	M	-0.42
C	-0.24	1-7	-0.25	J	-1.44	1-14	+0.32
1-4	-0.34	G	-0.24	1-11	-1.00	N	-0.30

STATION	DIFFERENCE +/-	STATION	DIFFERENCE +/-
1-15	-0.52	R	-0.29
O	+1.08	1-19	+0.02
1-16	+0.07	S	-0.18
P	-0.08		
1-17	-0.57		
Q	-0.59		
1-18	-0.14		

NOTE:
1) STATIONS ARE APPROXIMATELY EVERY 500 FT.

STATIONS	CROSS SECTIONS SHT. NO
1-1 THRU 1-4	1C-1
1-5 THRU 1-8	1C-2
1-9 THRU 1-15	1C-3
1-16 THRU 1-19	1C-4



Symbol	Description	Date	7 /

Designed by: J. BARRETT	Date: 1 APR 2009
Drawn by: J. SKRINDE	File: X
Checked by: X	Rev.

U.S. ARMY ENGINEER DISTRICT, SEATTLE
CORPS OF ENGINEERS
SEATTLE, WASHINGTON

SKAGIT COUNTY GI STUDY
DIKING DISTRICT #1
SITE LOCATIONS &
PROFILE DIFFERENTIAL
WASHINGTON
SKAGIT COUNTY

Plate number:
1G-1
Sheet 4 of 43



Symbol	Description	Date	Appr.	Symbol	Description
		7/7			

U.S. ARMY ENGINEER DISTRICT, SEATTLE CORPS OF ENGINEERS SEATTLE, WASHINGTON	Designed by: J. BARRETT	Date: 1 APR 2009
Prepared by:	Drawn by: J. SKRINDE	File: X
	Checked by: X	Rev. X

SKAGIT COUNTY GI STUDY
CROSS SECTIONS
1-1 THRU 1-4
SKAGIT COUNTY WASHINGTON

Plate number:
1C-1
Sheet 7 of 43

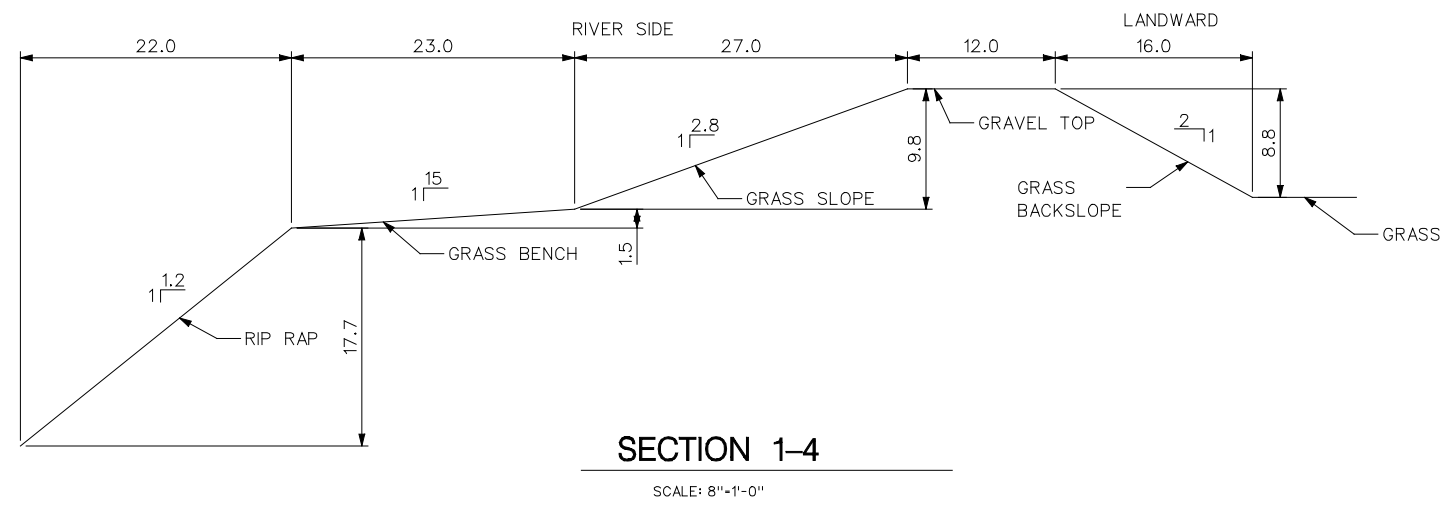
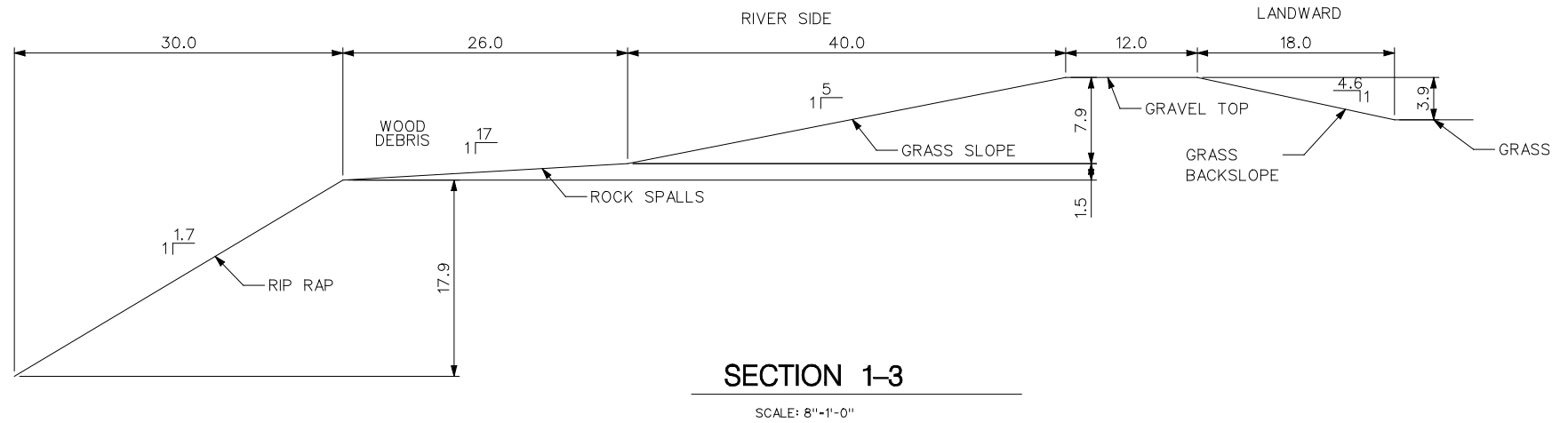
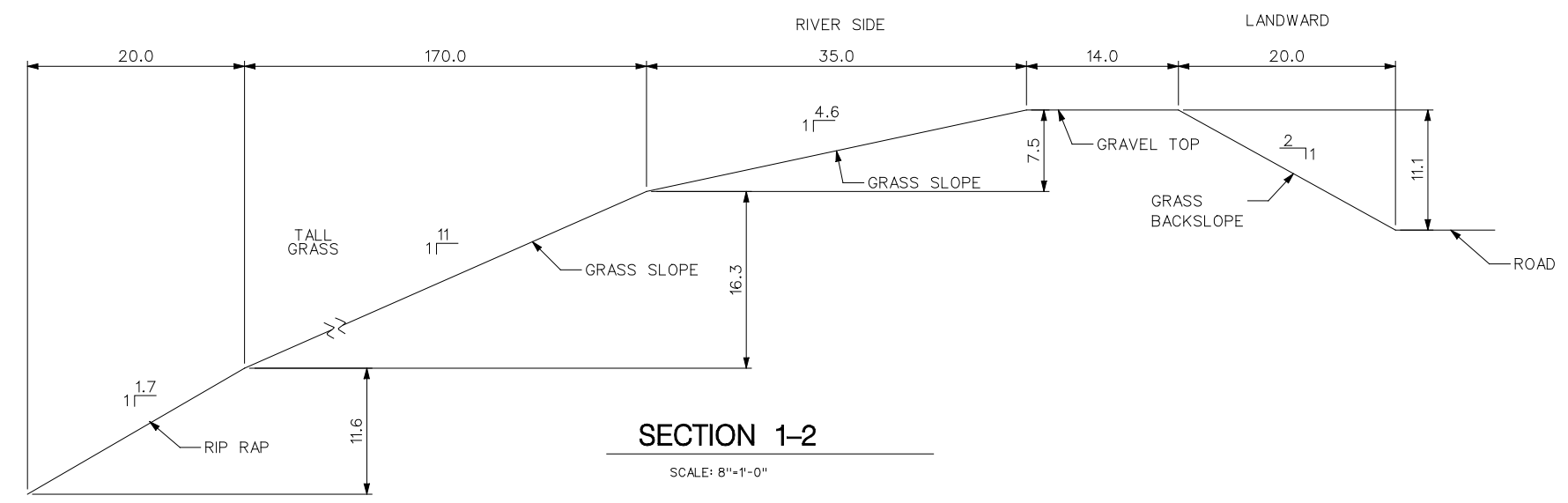
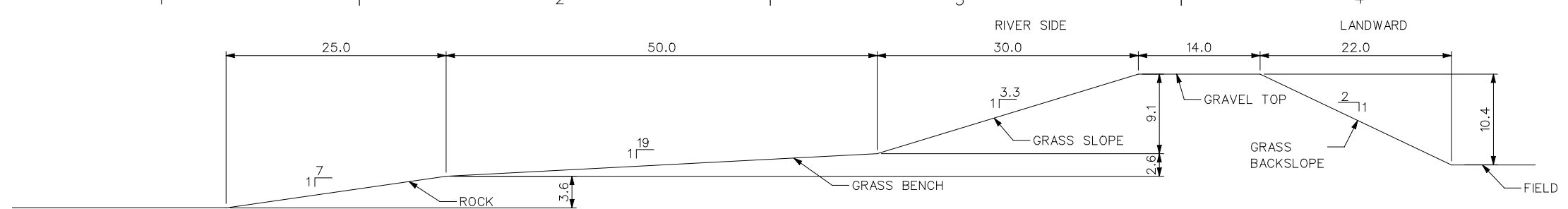

NOTE:
1. DIMENSIONS ARE IN FEET.



US Army Corps of Engineers
Seattle District

Symbol	Description	Date	Appr.	Symbol	Description
		7/7			

U.S. ARMY ENGINEER DISTRICT, SEATTLE CORPS OF ENGINEERS SEATTLE, WASHINGTON	Designed by: J. BARRETT	Date: 1 APR 2009
Prepared by:	Drawn by: J. SKRINDE	File: X
	Checked by: X	Rev.:

SKAGIT COUNTY GI STUDY
CROSS SECTIONS
1-5 THRU 1-8
SKAGIT COUNTY WASHINGTON

Plate number:
1C-2
Sheet 8 of 43

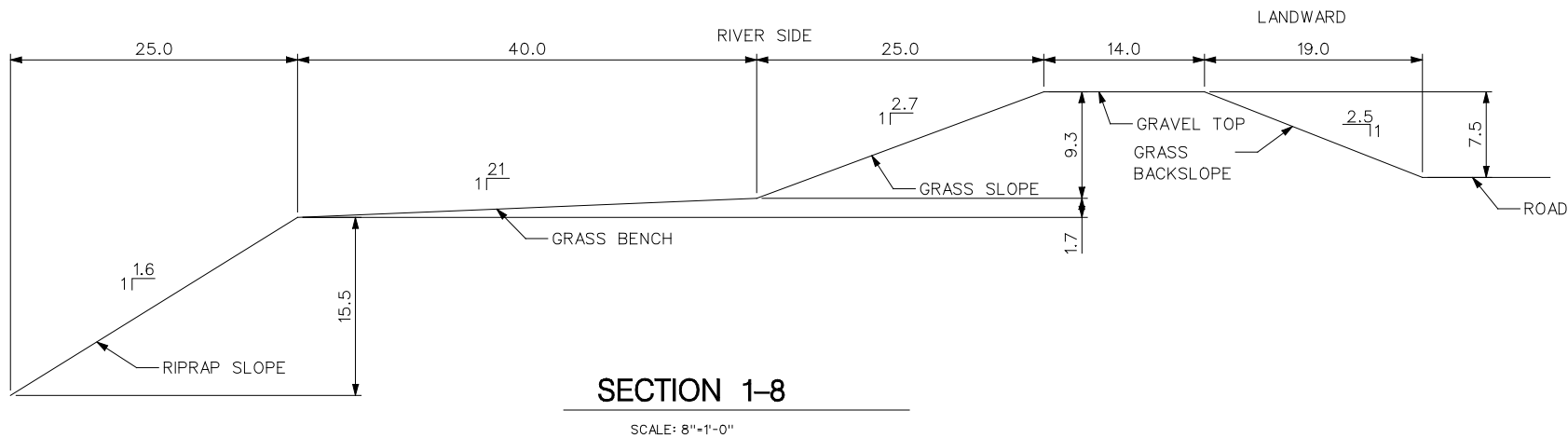
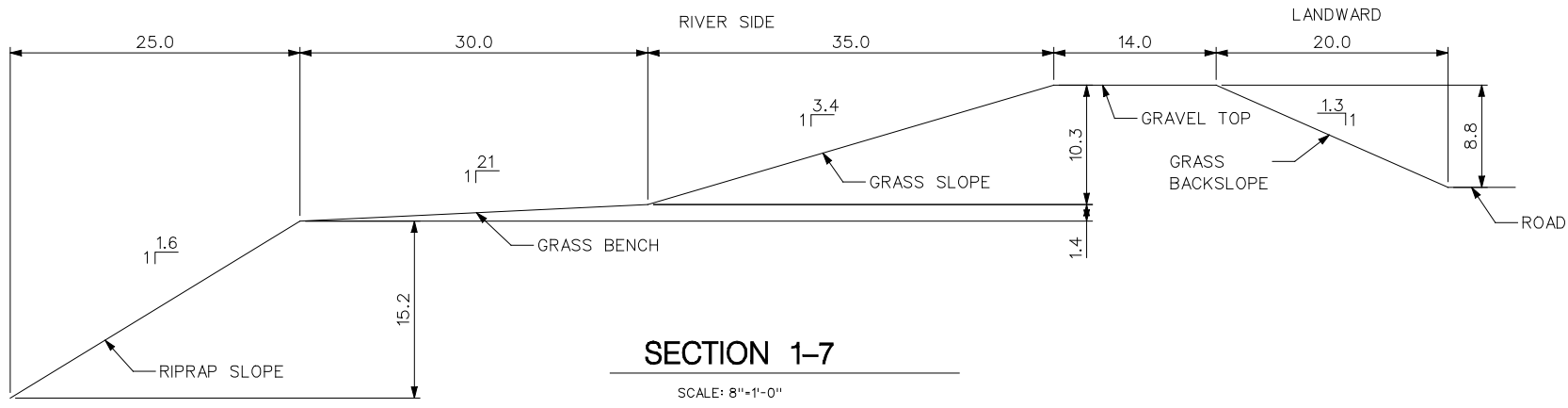
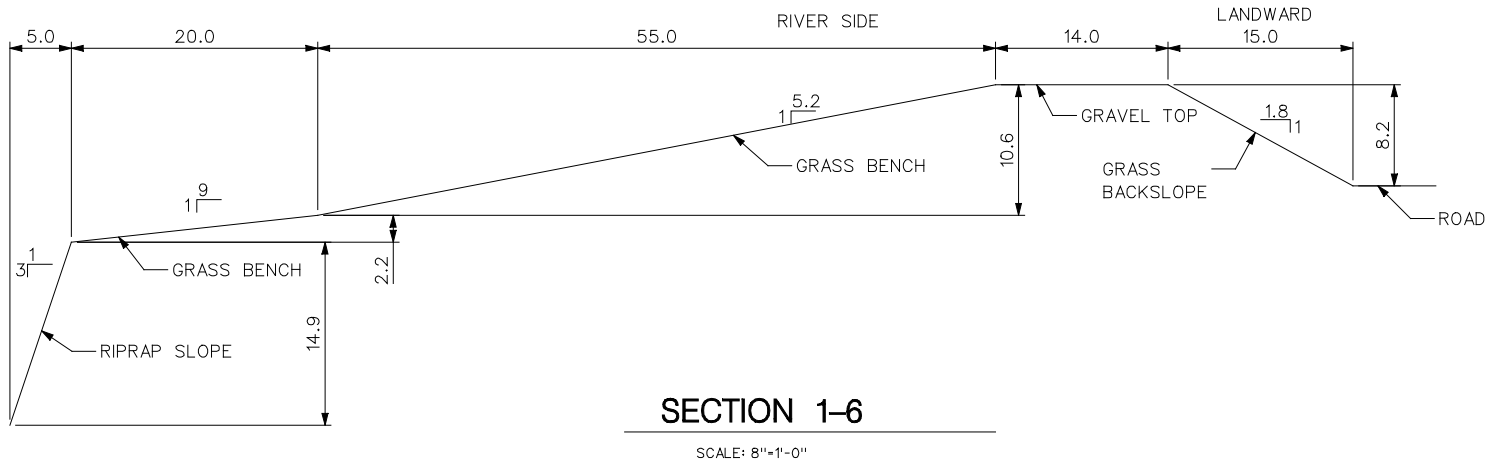
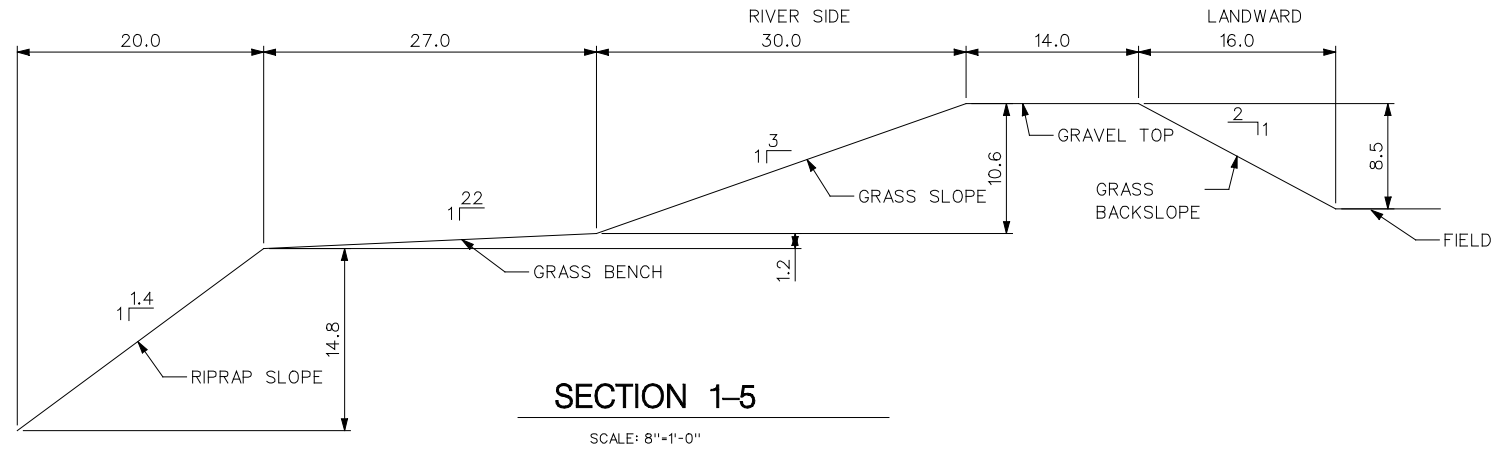

NOTE:
1. DIMENSIONS ARE IN FEET.



Symbol	Description	Date	Appr.	Symbol	Description
		7/7			

Designed by:	J. BARRETT	Date:	1 APR 2009
Drawn by:	J. SKRINDE	File #	X
Checked by:	X	Rev.	

U.S. ARMY ENGINEER DISTRICT, SEATTLE
 CORPS OF ENGINEERS
 SEATTLE, WASHINGTON

SKAGIT COUNTY GI STUDY
 CROSS SECTIONS
 1-9 THRU 1-15
 SKAGIT COUNTY WASHINGTON

Plate number:
1C-3
 Sheet 9 of 43

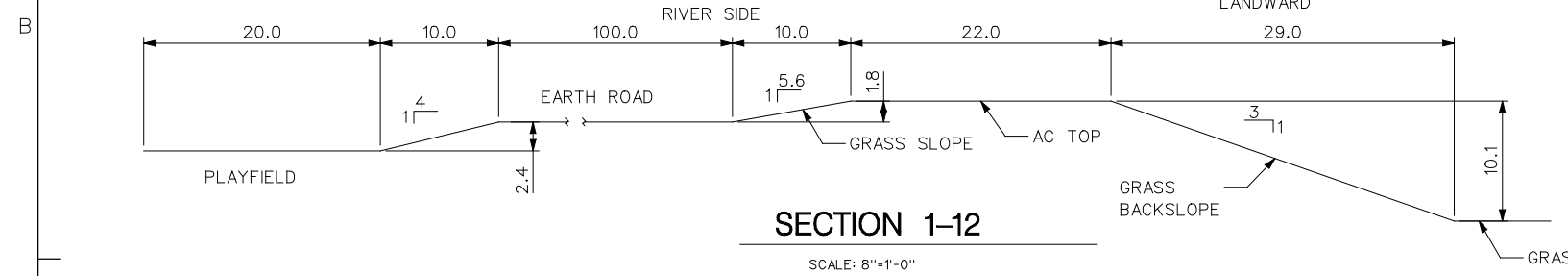
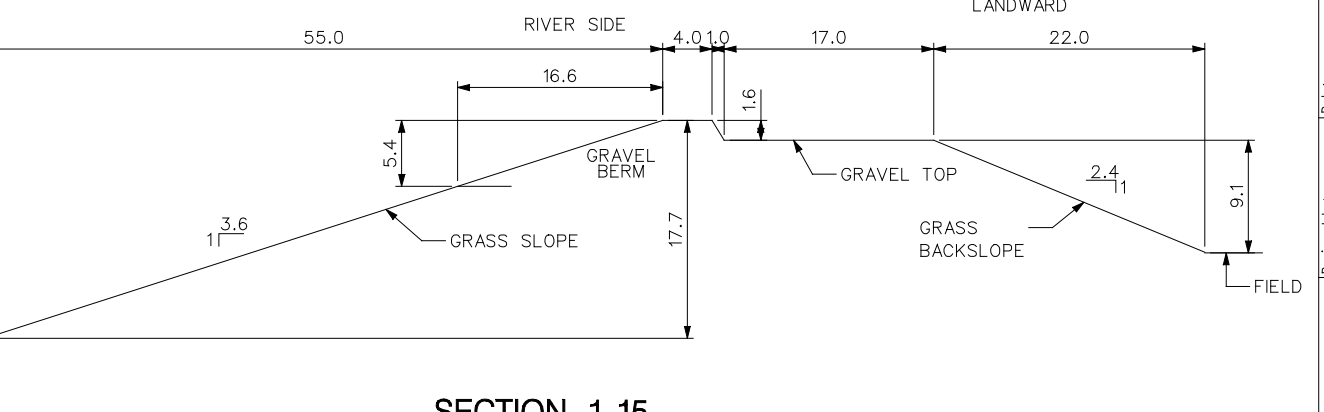
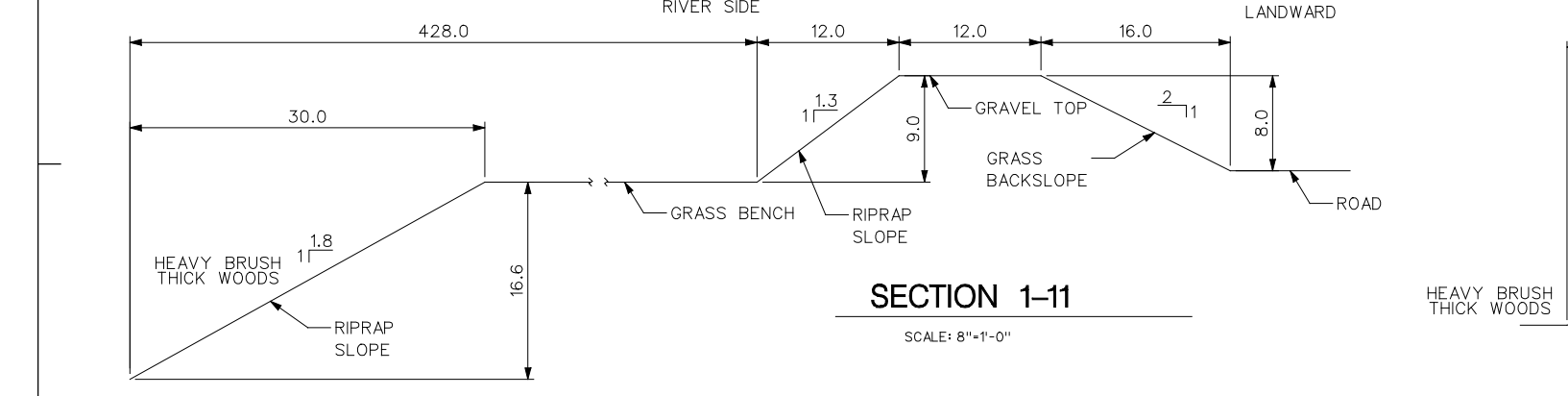
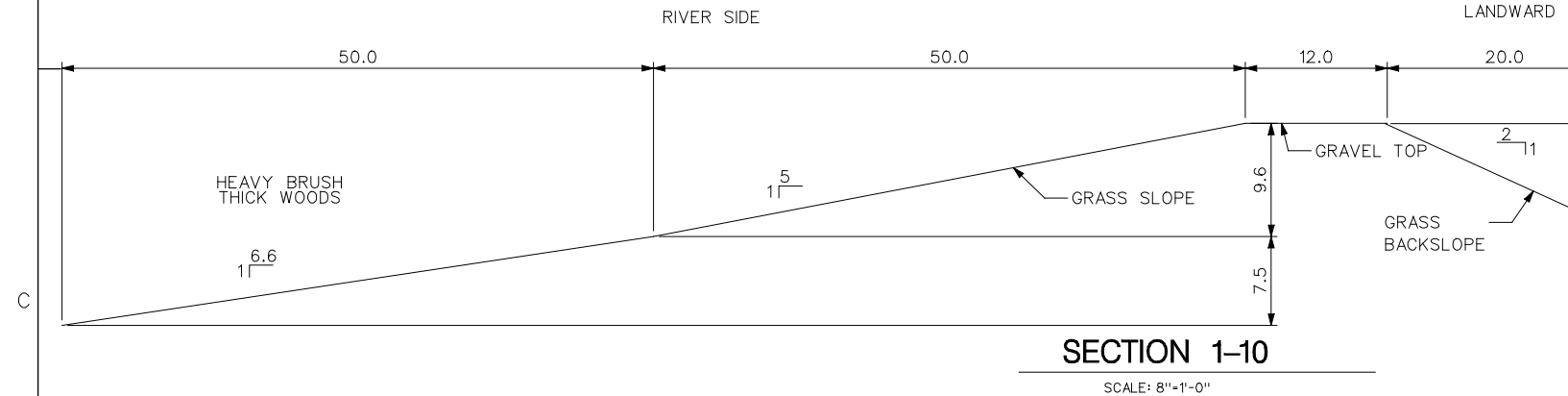
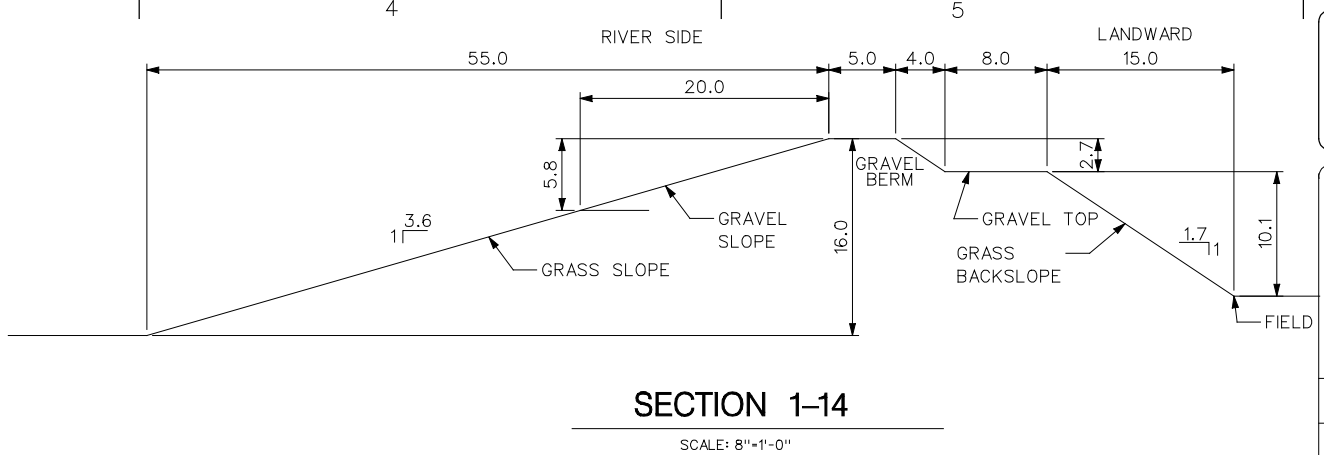
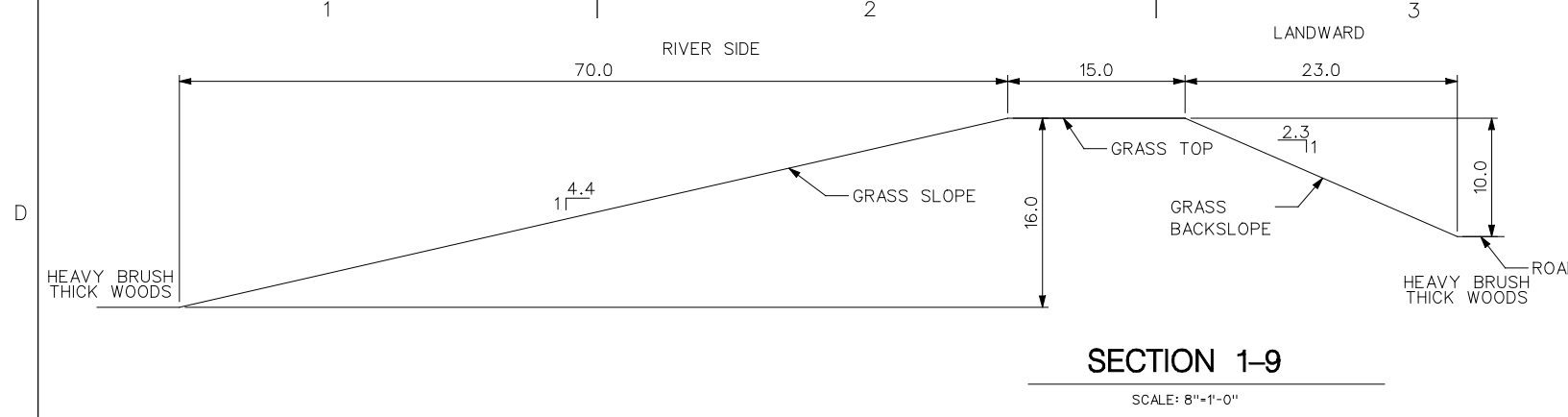

NOTE:
 1. DIMENSIOS ARE IN FEET.

DATE AND TIME PLOTTED: 4/9/2009 8:42:41 AM DESIGN FILE: I:\MISC\CIV\SKAGIT COUNTY GI STUDY\DD1\SCG1C-103DD1.DGN



SITE LOCATIONS
1"=500'

PROFILE DIFFERENTIAL

STATION	DIFFERENCE +/-	STATION	DIFFERENCE +/-	STATION	DIFFERENCE +/-	STATION	DIFFERENCE +/-
3-1	0	C	-0.20	3-9	-0.48	J	+0.02
3-2	+0.14	3-6	-0.30	G	-0.18	3-13	-0.02
A	-0.18	D	-0.22	3-10	+0.64	K	-0.30
3-3	-0.27	3-7	-0.34	H	+0.74		
3-4	+0.28	E	+1.68	3-11	-0.02		
B	+0.04	3-8	+0.06	I	-0.26		
3-5	+0.02	F	+0.18	3-12	-0.22		

NOTE:
1) STATIONS ARE APPROXIMATELY EVERY 500 FT.

STATIONS	CROSS SECTIONS SHT. NO
1-1 THRU 1-4	1C-1
1-5 THRU 1-8	1C-2
1-9 THRU 1-15	1C-3
1-16 THRU 1-19	1C-4

Symbol	Description	Date	Appr.	Symbol	Description

U.S. ARMY ENGINEER DISTRICT, SEATTLE CORPS OF ENGINEERS SEATTLE, WASHINGTON	Designed by: J. BARRETT Drawn by: J. SKRINDE Checked by: X	Date: 1 APR 2009 File: X Rev.:
---	---	--

SKAGIT COUNTY GI STUDY
DIKING DISTRICT #3
SITE LOCATIONS &
PROFILE DIFFERENTIAL
SKAGIT COUNTY WASHINGTON

Plate number:
3G-1
Sheet 16 of 43



US Army Corps
of Engineers
Seattle District

A
B
C
D

1 2 3 4 5

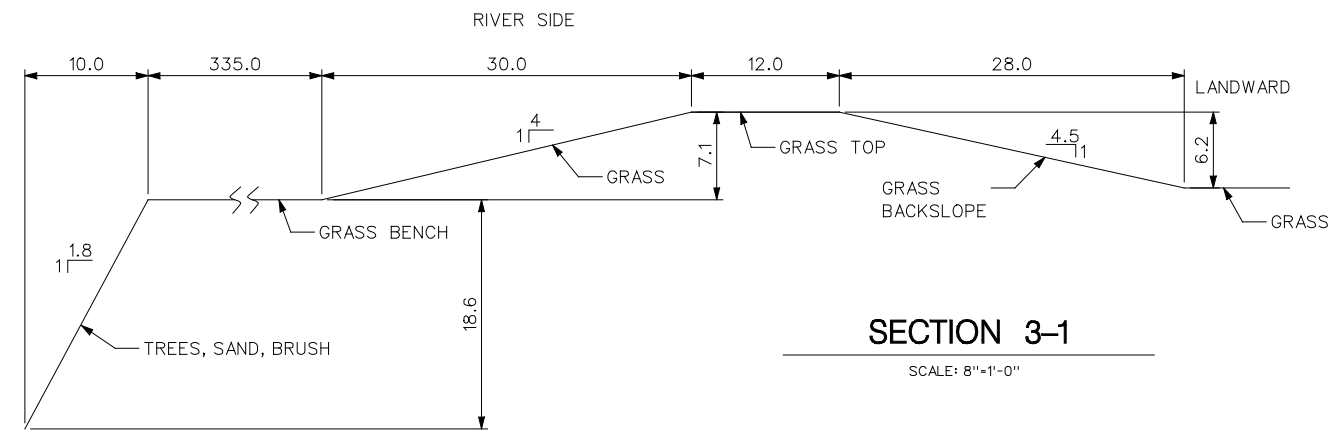

SECTION 3-1
SCALE: 8"=1'-0"

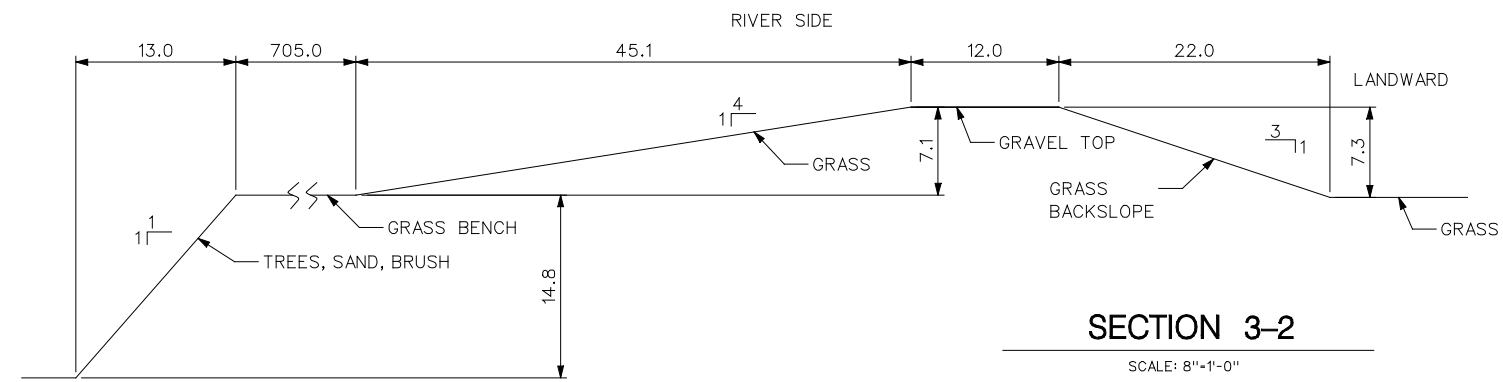

SECTION 3-2
SCALE: 8"=1'-0"

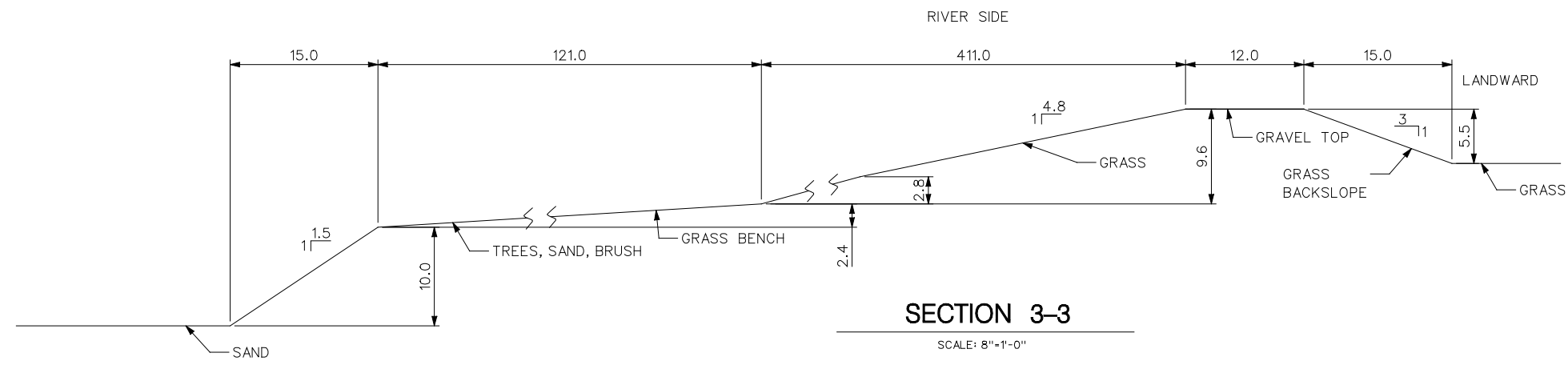

SECTION 3-3
SCALE: 8"=1'-0"

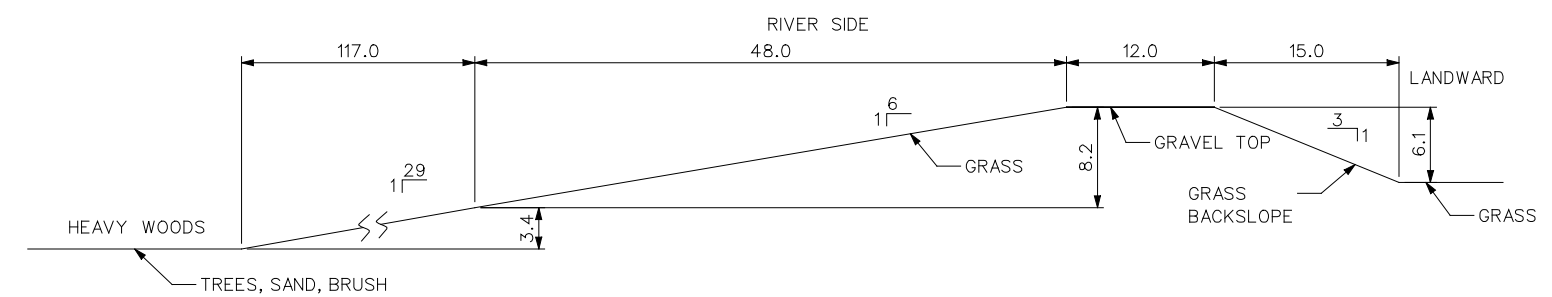

SECTION 3-4
SCALE: 8"=1'-0"

Description	Symbol	Appr.	Date
			7 /

U.S. ARMY ENGINEER DISTRICT, SEATTLE CORPS OF ENGINEERS SEATTLE, WASHINGTON	Designed by: J. BARRETT	Date: 1 APR 2009
	Drawn by: J. SKRINDE	File: X
Prepared by:	Checked by: X	Rev.: X

SKAGIT COUNTY GI STUDY
CROSS SECTIONS
3-1 THRU 3-4
SKAGIT COUNTY WASHINGTON

Plate
number:
3C-1
Sheet 19 of 43

NOTE:
1. DIMENSIONS ARE IN FEET.

DATE AND TIME PLOTTED: 4/9/2009 9:06:09 AM DESIGN FILE: I:\MISC\CIV\SKAGIT COUNTY GI STUDY\DD3\SCGIC-10IDD3.DGN



US Army Corps
of Engineers
Seattle District

Symbol	Description	Date	Appr.
		7/7	

U.S. ARMY ENGINEER DISTRICT, SEATTLE CORPS OF ENGINEERS SEATTLE, WASHINGTON	Designed by: J. BARRETT	Date: 1 APR 2009
Prepared by:	Drawn by: J. SKRINDE	File: X
	Checked by: X	Rev.:

SKAGIT COUNTY GI STUDY
CROSS SECTIONS
3-5 THRU 3-8
SKAGIT COUNTY WASHINGTON

Plate number:
30-2
Sheet 20 of 43

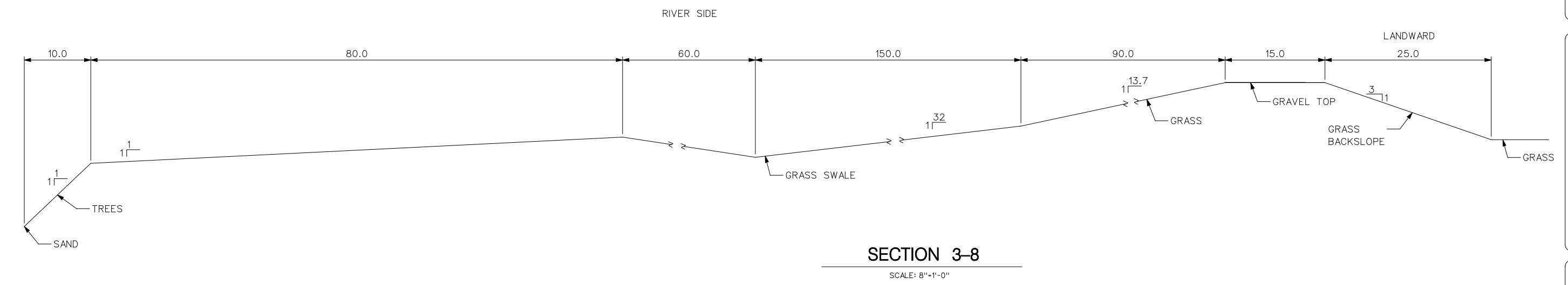
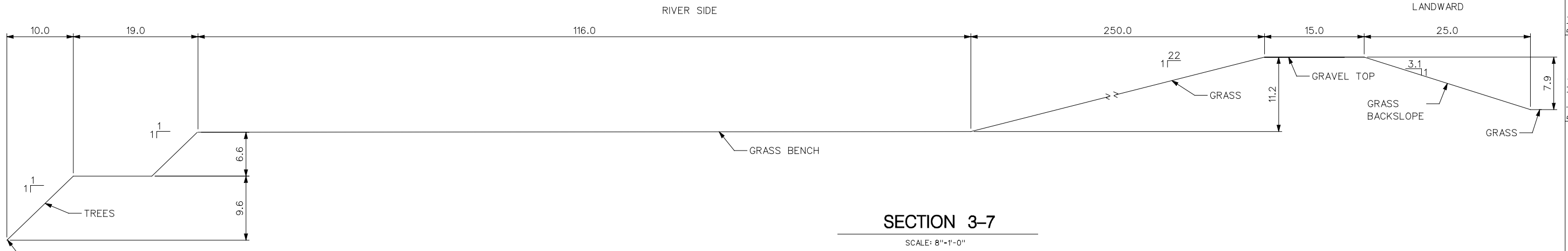
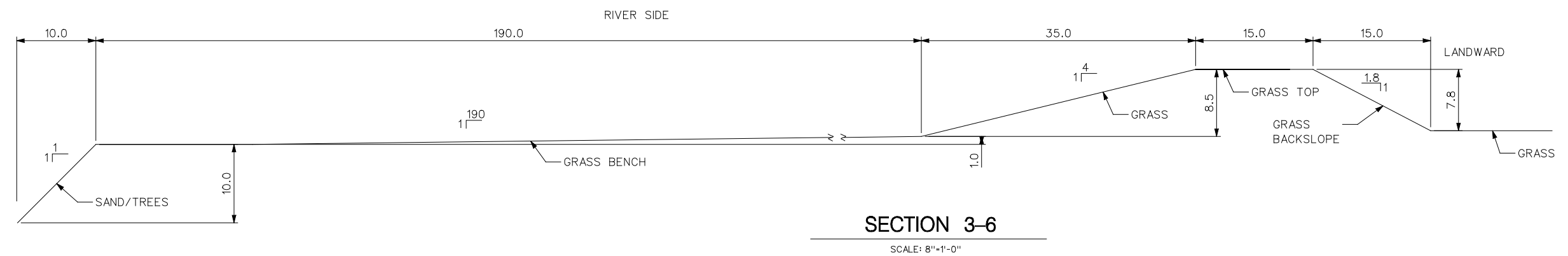
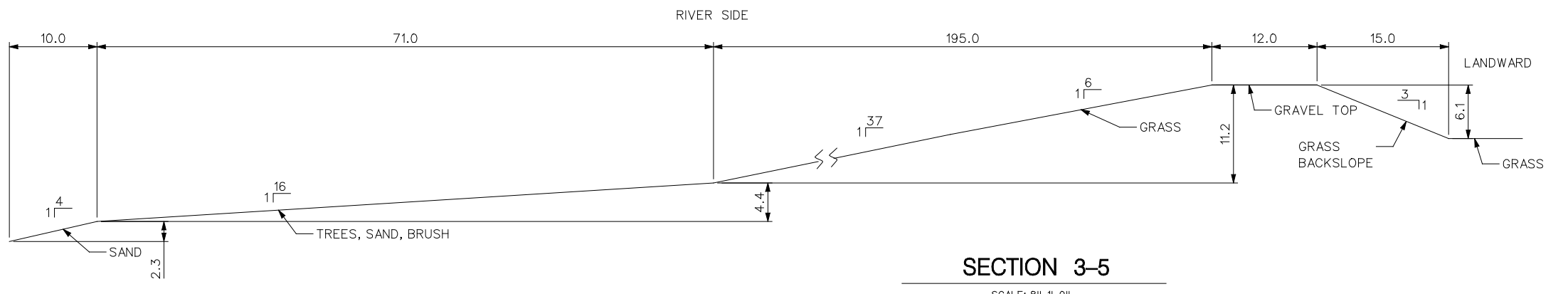

NOTE:
1. DIMENSIONS ARE IN FEET.



US Army Corps
of Engineers
Seattle District

Description	Date	Appr.	Symbol
	7/7		

Description	Date	Appr.	Symbol

Designed by:	J. BARRETT	Date:	1 APR 2009
Drawn by:	J. SKRINDE	File:	X
Checked by:	X	Rev.:	X

U.S. ARMY ENGINEER DISTRICT, SEATTLE
CORPS OF ENGINEERS
SEATTLE, WASHINGTON

SKAGIT COUNTY GI STUDY
CROSS SECTIONS
3-9 THRU 3-12
SKAGIT COUNTY WASHINGTON

Plate number:
30-3
Sheet 21 of 43

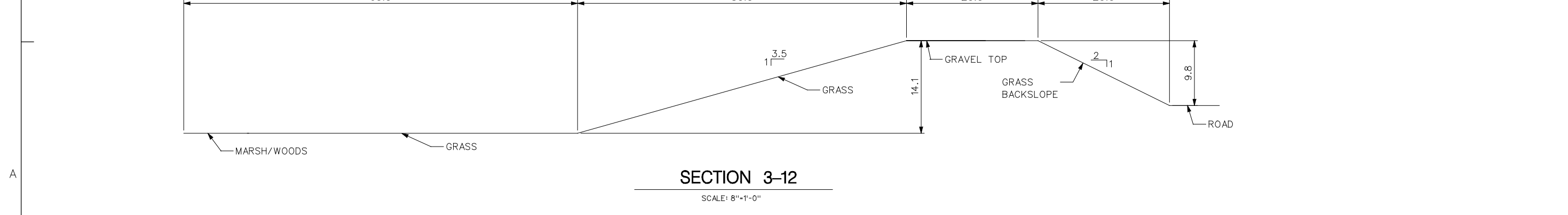
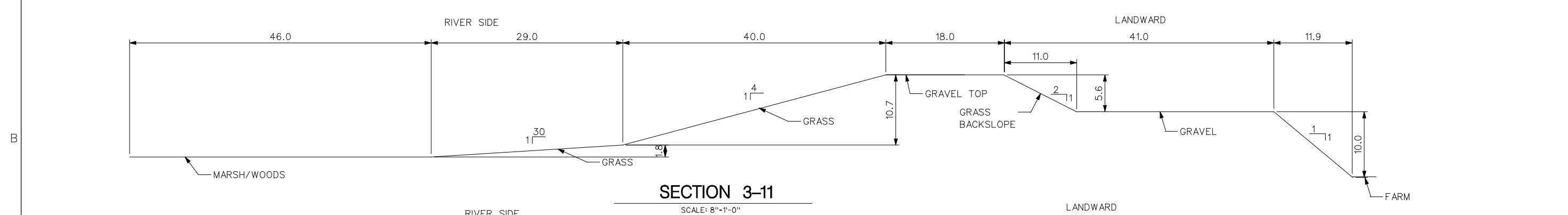
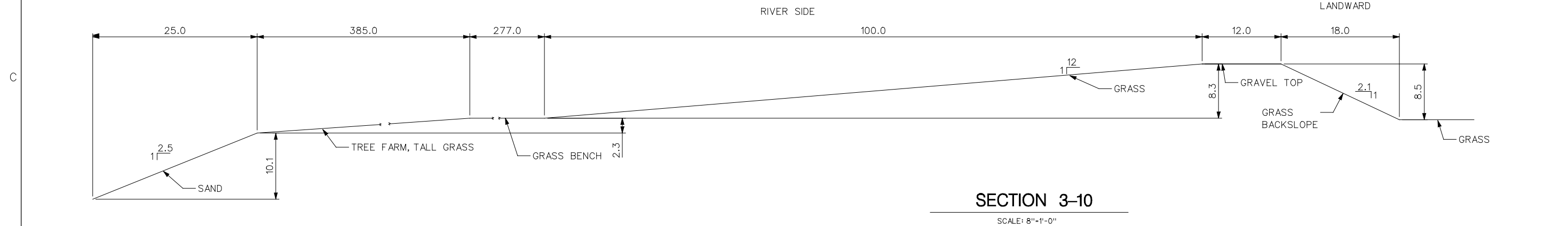
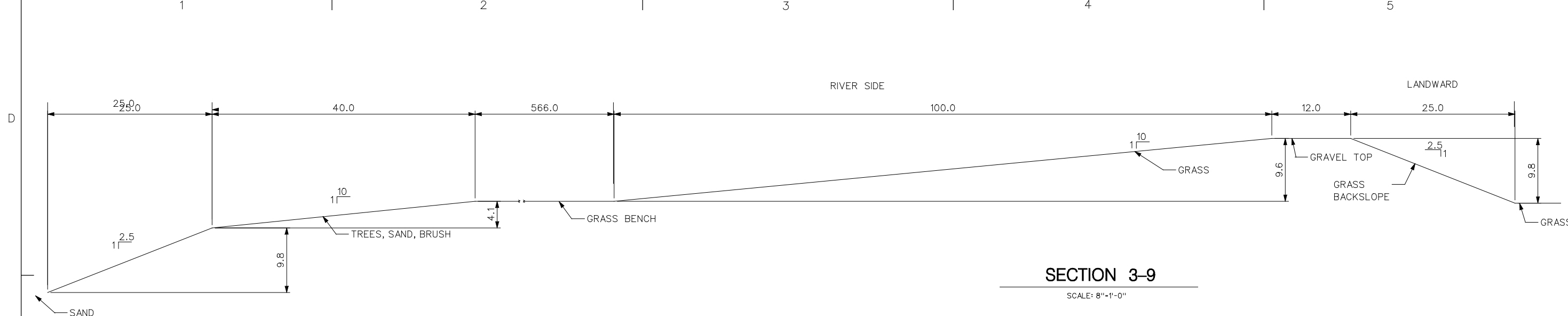

NOTE:
1. DIMENSIONS ARE IN FEET.

DATE AND TIME PLOTTED: 4/9/2009 9:09:44 AM DESIGN FILE: I:\MISC\CIV\SKAGIT COUNTY GI STUDY\DD3\SCGIC-103DD3.DGN



Symbol	Description	Date	Appr.	Symbol	Description
		7/7			

U.S. ARMY ENGINEER DISTRICT, SEATTLE CORPS OF ENGINEERS SEATTLE, WASHINGTON	Designed by: J. BARRETT Drawn by: J. SKRINDE Checked by: X	Date: 1 APR 2009 File: X Rev.
---	---	---

SKAGIT COUNTY GI STUDY
DIKING DISTRICT #17
SITE LOCATIONS &
PROFILE DIFFERENTIAL
SKAGIT COUNTY WASHINGTON

Plate number:
17G-1
Sheet 27 of 43



SITE LOCATIONS
1"=600'

PROFILE DIFFERENTIAL

STATION	DIFFERENCE +/-	STATION	DIFFERENCE +/-	STATION	DIFFERENCE +/-	STATION	DIFFERENCE +/-	STATION	DIFFERENCE +/-	STATION	DIFFERENCE +/-	STATION	DIFFERENCE +/-
17-1	0	D	-1.82	17-8	-0.06	K	+0.14	17-15	-0.52	R	-0.06	17-22	-0.42
17-2	-0.56	17-5	-0.12	H	-0.16	17-12	-0.34	O	-0.16	17-19	-0.20	V	-0.04
A	-0.10	E	+0.02	17-9	-0.42	L	-0.14	17-16	-0.08	S	-0.10	17-23	+0.72
17-3	-0.40	17-6	+0.38	I	-0.36	17-13	-0.13	P	-0.25	17-20	-0.28		
B	-0.50	F	-0.72	17-10	+0.24	M	+1.20	17-17	+0.04	T	-0.16		
C	-0.54	17-7	-0.26	J	-0.20	17-14	-0.43	Q	-0.10	17-21	+0.06		
17-4	-0.22	G	+0.10	17-11	+0.04	N	-0.46	17-18	-0.40	U	+0.08		

NOTE:
1) STATIONS ARE APPROXIMATELY EVERY 500 FT.

STATIONS	CROSS SECTIONS SHT. NO
17-1 THRU 17-5	17C-1
17-6 THRU 17-8	17C-2
17-9 THRU 17-12	17C-3
17-13 THRU 17-16	17C-4
17-17 THRU 17-20	17C-5
17-21 THRU 17-24	17C-6



US Army Corps of Engineers
Seattle District

Description	Symbol	Date	Appr.

U.S. ARMY ENGINEER DISTRICT, SEATTLE CORPS OF ENGINEERS SEATTLE, WASHINGTON	Designed by: J. BARRETT	Date: 1 APR 2009
Prepared by:	Drawn by: J. SKRINDE	File: X
	Checked by: X	Rev. X

SKAGIT COUNTY GI STUDY
CROSS SECTIONS
17-1 THRU 17-5
SKAGIT COUNTY WASHINGTON

Plate number:
17C-1
Sheet 28 of 43

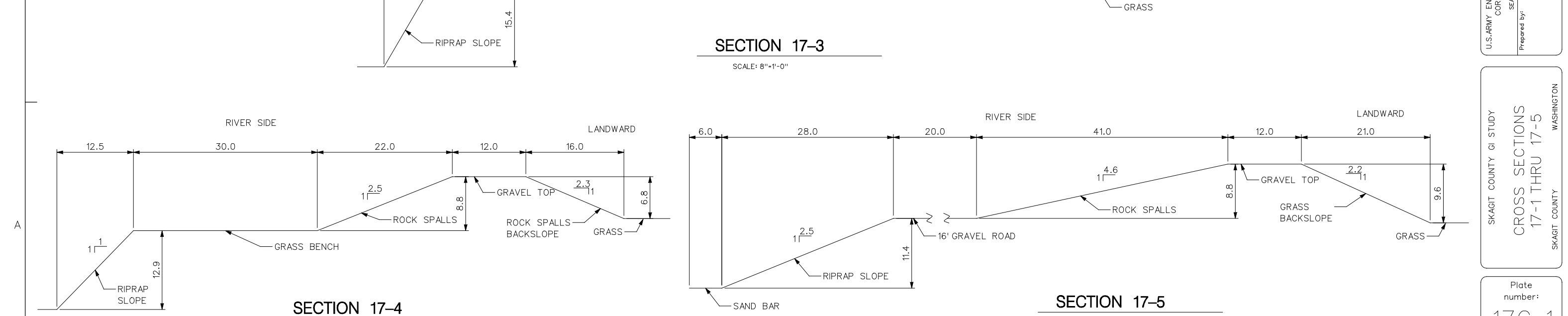
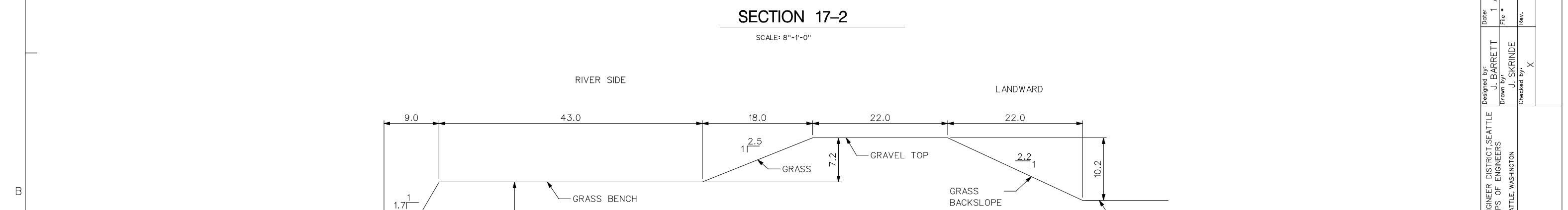
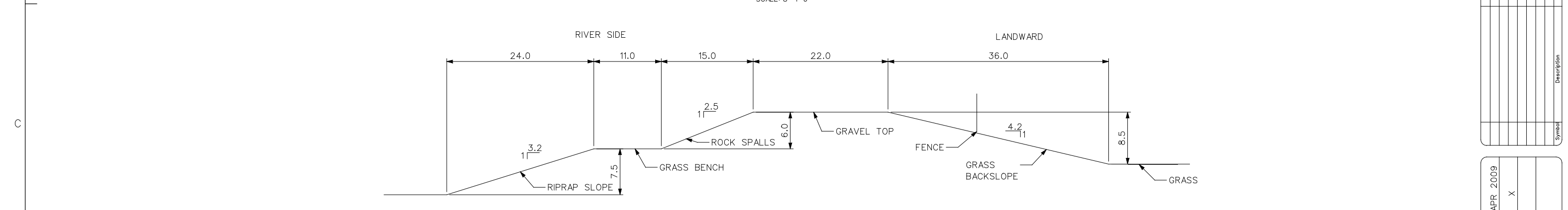
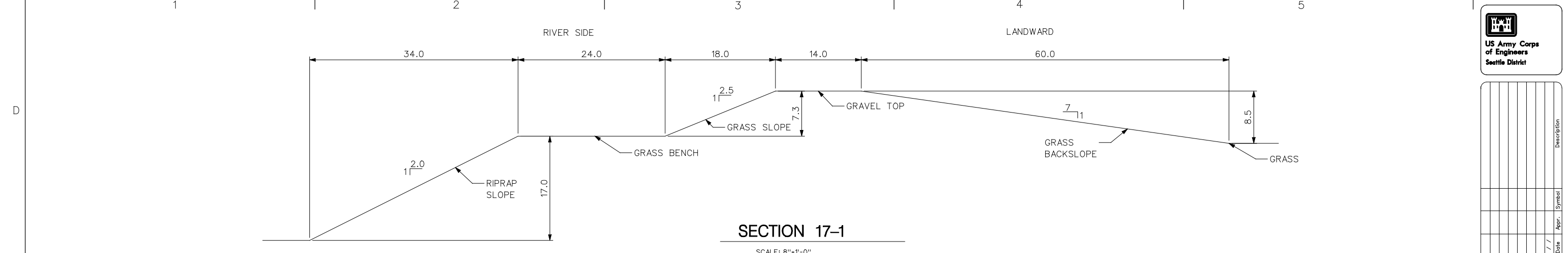

NOTE:
1. DIMENSIONS ARE IN FEET.

DATE AND TIME PLOTTED: 4/9/2009 9:26:00 AM DESIGN FILE: I:\MISC\CIV\SKAGIT COUNTY GI STUDY\DD17\SCGIC-101DD17.DGN



US Army Corps of Engineers
Seattle District

Description	Symbol	Date	Appr.
		7 /	

Designed by:	Date:
J. BARRETT	1 APR 2009
Drawn by:	File
J. SKRINDE	X
Checked by:	Rev.
X	

U.S. ARMY ENGINEER DISTRICT, SEATTLE
CORPS OF ENGINEERS
SEATTLE, WASHINGTON

Prepared by:

SKAGIT COUNTY GI STUDY
CROSS SECTIONS
17-6 THRU 17-8
SKAGIT COUNTY WASHINGTON

Plate number:
17C-2
Sheet 29 of 43

1 2 3 4 5

D

C

B

A

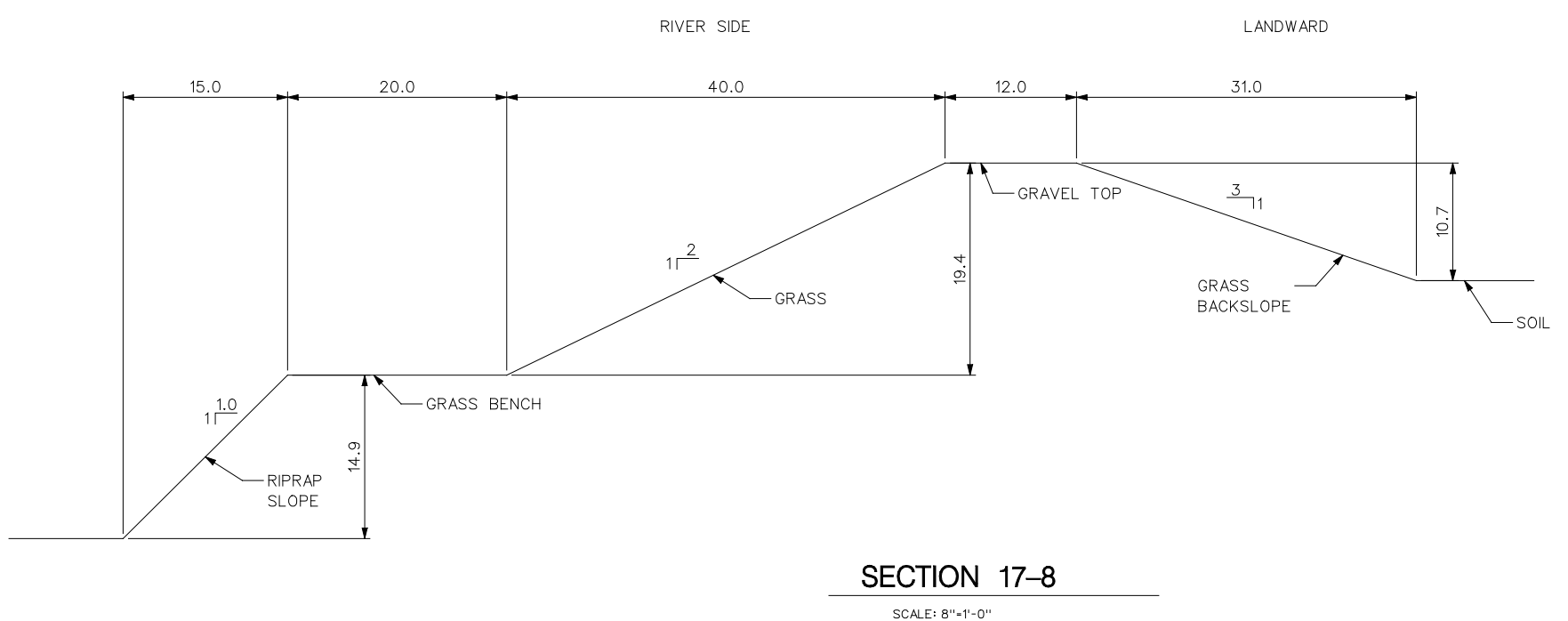
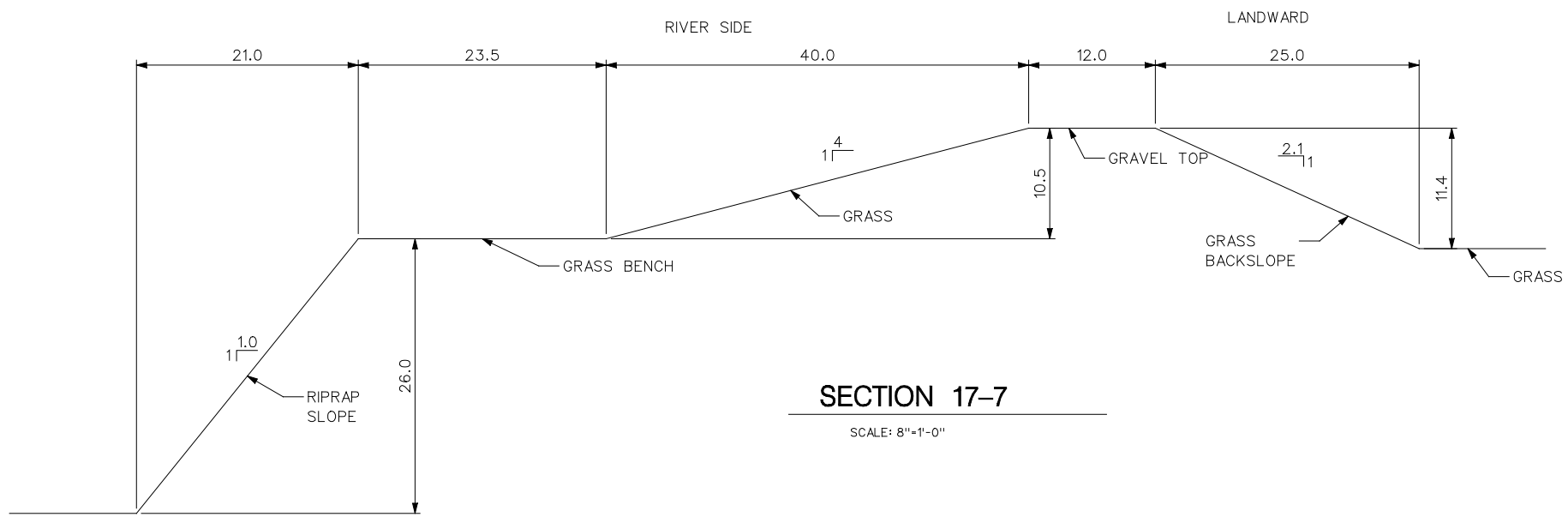
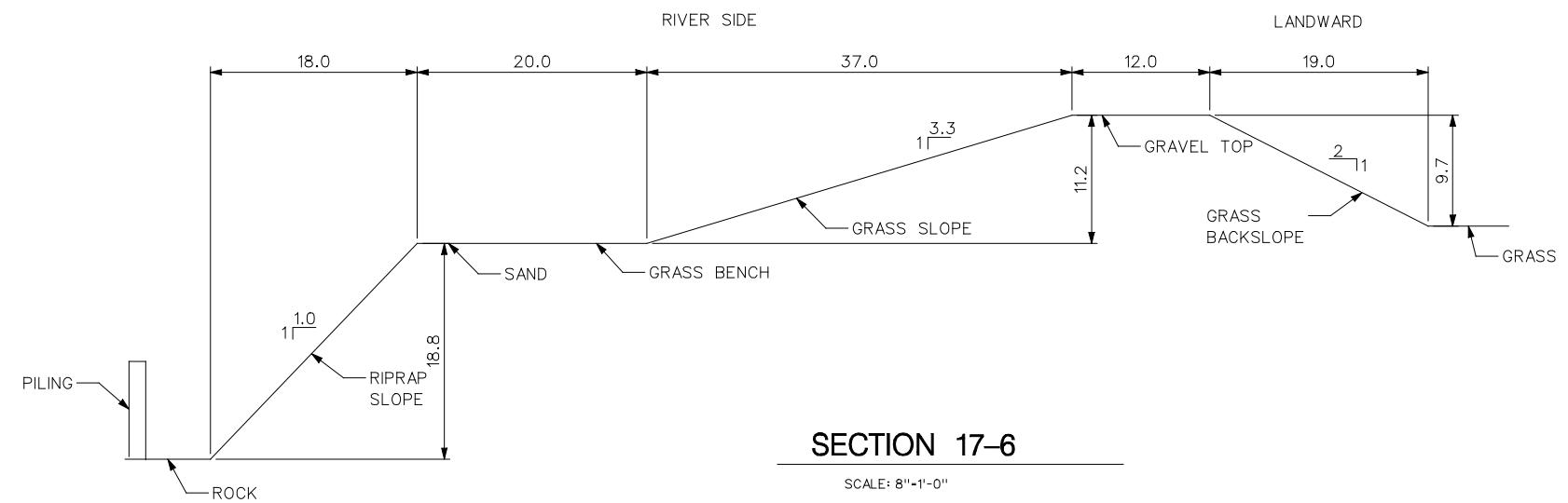

NOTE:
1. DIMENSIONS ARE IN FEET.

DATE AND TIME PLOTTED: 4/9/2009 9:27:28 AM DESIGN FILE: I:\MISC\CIV\SKAGIT COUNTY GI STUDY\DD17\SCGIC-102DD17.DGN

Description	Symbol	Appr.	Date

Designed by:	Date:
J. BARRETT	1 APR 2009
Drawn by:	File
J. SKRINDE	X
Checked by:	Rev.
X	

U.S. ARMY ENGINEER DISTRICT, SEATTLE
CORPS OF ENGINEERS
SEATTLE, WASHINGTON

SKAGIT COUNTY GI STUDY
CROSS SECTIONS
17-21 THRU 17-24
SKAGIT COUNTY WASHINGTON

Plate number:
17C-6
Sheet 33 of 43

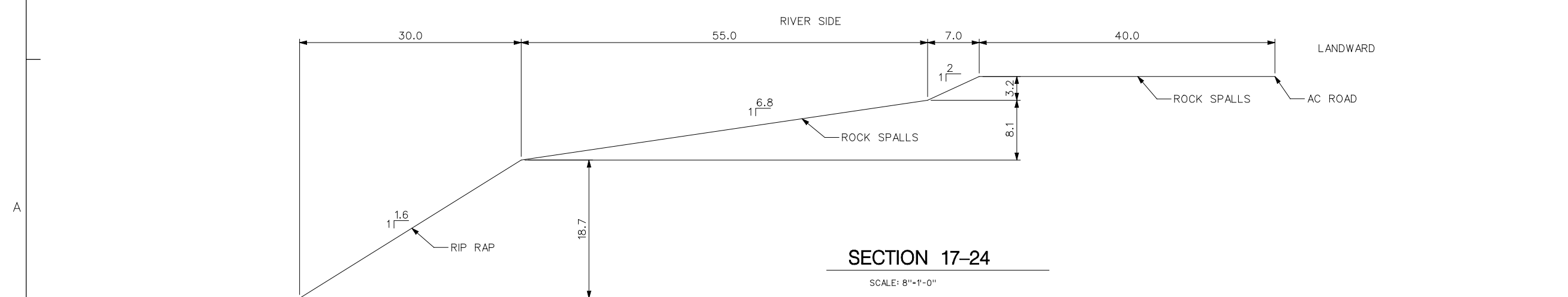
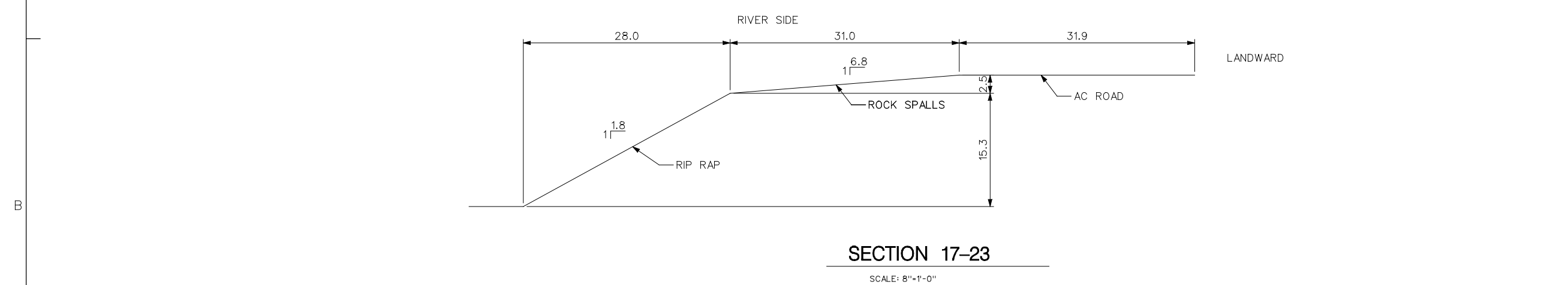
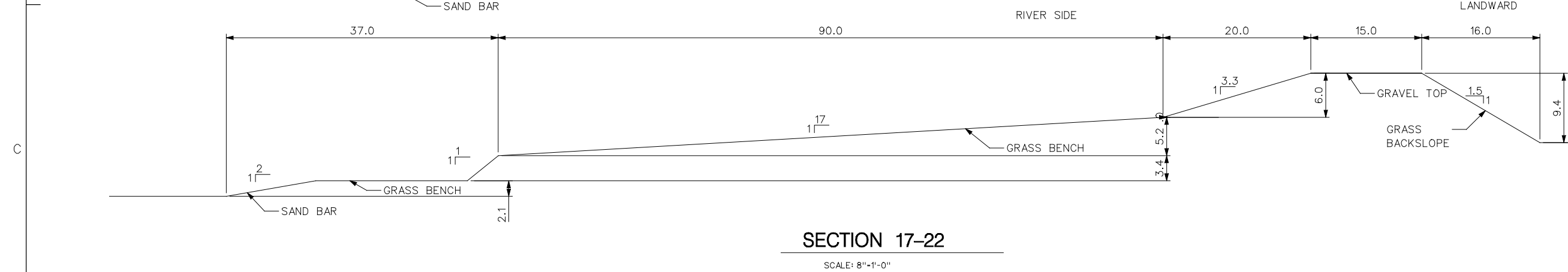
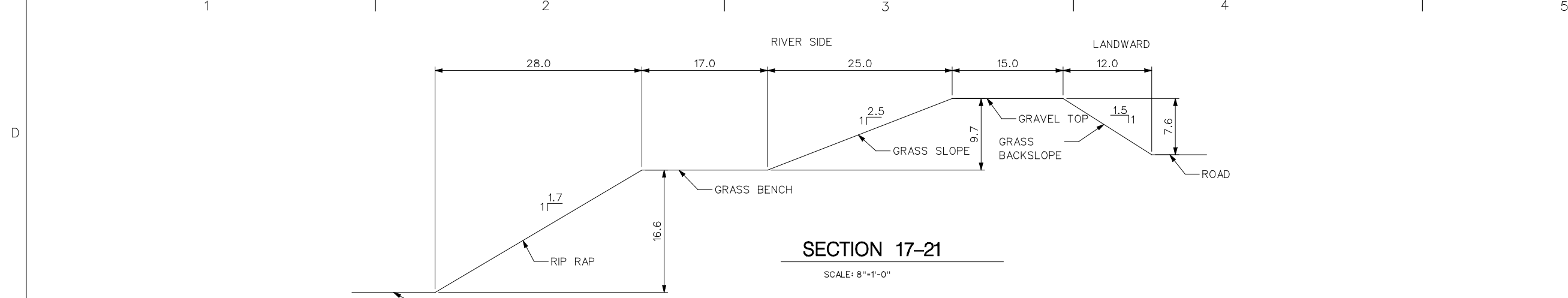

NOTE:
1. DIMENSIONS ARE IN FEET.

Water Surface Elevations used for Levee Raise Profiles

These three water surface profiles incorporate additional upper and Lower Baker flood storage and the urban levee raises. They also combine the "with debris" elevations upstream of the BNSF Bridge, with "no debris" elevations downstream of the bridge.

75-yr Up+Low Baker Levee Raise					100-yr Up+Low Baker Levee Raise					250-yr Up+Low Baker Levee Raise				
River	Reach	RM	Ch Dist	Max WS-W.S. Elev	River	Reach	RM	Ch Dist	Max WS-W.S. Elev	River	Reach	RM	Ch Dist	Max WS-W.S. Elev
253 Skagit River	BakertoConcrete	23.2	78670.65	52.62	253 Skagit River	BakertoConcrete	23.2	78670.65	53.34	253 Skagit River	BakertoConcrete	23.2	78670.65	55.8
254 Skagit River	BakertoConcrete	22.5	75350.65	51.88	254 Skagit River	BakertoConcrete	22.5	75350.65	52.61	254 Skagit River	BakertoConcrete	22.5	75350.65	55.1
255 Skagit River	BakertoConcrete	22.4	74750.65	50.9	255 Skagit River	BakertoConcrete	22.4	74750.65	51.59	255 Skagit River	BakertoConcrete	22.4	74750.65	54.08
256 Skagit River	BakertoConcrete	22.39	74690.65	50.85	256 Skagit River	BakertoConcrete	22.39	74690.65	51.54	256 Skagit River	BakertoConcrete	22.39	74690.65	54.02
257 Skagit River	BakertoConcrete	22.38	74668.65	49.38	257 Skagit River	BakertoConcrete	22.38	74668.65	50.2	257 Skagit River	BakertoConcrete	22.38	74668.65	51.46
258 Skagit River	BakertoConcrete	22.3	74528.65	49.7	258 Skagit River	BakertoConcrete	22.3	74528.65	50.5	258 Skagit River	BakertoConcrete	22.3	74528.65	51.94
259 Skagit River	BakertoConcrete	22.29	74468.65	49.67	259 Skagit River	BakertoConcrete	22.29	74468.65	50.47	259 Skagit River	BakertoConcrete	22.29	74468.65	51.89
260 Skagit River	BakertoConcrete	22.28	74433.65	49.63	260 Skagit River	BakertoConcrete	22.28	74433.65	50.43	260 Skagit River	BakertoConcrete	22.28	74433.65	51.83
261 Skagit River	BakertoConcrete	22.27	74383.65	49.6	261 Skagit River	BakertoConcrete	22.27	74383.65	50.4	261 Skagit River	BakertoConcrete	22.27	74383.65	51.79
262 Skagit River	BakertoConcrete	22.2	71122.07	49.34	262 Skagit River	BakertoConcrete	22.2	71122.07	50.12	262 Skagit River	BakertoConcrete	22.2	71122.07	51.4
263 Skagit River	BakertoConcrete	22	68287.19	49.25	263 Skagit River	BakertoConcrete	22	68287.19	50.04	263 Skagit River	BakertoConcrete	22	68287.19	51.3
264 Skagit River	BakertoConcrete	21.93	66109.87	49.22	264 Skagit River	BakertoConcrete	21.93	66109.87	50	264 Skagit River	BakertoConcrete	21.93	66109.87	51.26
265 Skagit River	BakertoConcrete	21.6	63459.87	49.16	265 Skagit River	BakertoConcrete	21.6	63459.87	49.94	265 Skagit River	BakertoConcrete	21.6	63459.87	51.19
266 Skagit River	BakertoConcrete	20.9	60161.23	48.9	266 Skagit River	BakertoConcrete	20.9	60161.23	49.71	266 Skagit River	BakertoConcrete	20.9	60161.23	50.97
267 Skagit River	BakertoConcrete	20	55448.43	48.42	267 Skagit River	BakertoConcrete	20	55448.43	49.28	267 Skagit River	BakertoConcrete	20	55448.43	50.55
268 Skagit River	BakertoConcrete	19.48	53117.05	48.28	268 Skagit River	BakertoConcrete	19.48	53117.05	49.16	268 Skagit River	BakertoConcrete	19.48	53117.05	50.43
269 Skagit River	BakertoConcrete	18.57	48709.38	48.01	269 Skagit River	BakertoConcrete	18.57	48709.38	48.91	269 Skagit River	BakertoConcrete	18.57	48709.38	50.18
270 Skagit River	BakertoConcrete	17.9	45815	47.73	270 Skagit River	BakertoConcrete	17.9	45815	48.67	270 Skagit River	BakertoConcrete	17.9	45815	49.93
271 Skagit River	BakertoConcrete	17.56	43388.49	47.15	271 Skagit River	BakertoConcrete	17.56	43388.49	48.11	271 Skagit River	BakertoConcrete	17.56	43388.49	49.32
272 Skagit River	BakertoConcrete	17.55	43253.76	46.16	272 Skagit River	BakertoConcrete	17.55	43253.76	46.77	272 Skagit River	BakertoConcrete	17.55	43253.76	48.09
273 Skagit River	BakertoConcrete	17.53	43197.78	45.99	273 Skagit River	BakertoConcrete	17.53	43197.78	46.56	273 Skagit River	BakertoConcrete	17.53	43197.78	47.43
274 Skagit River	BakertoConcrete	17.52	43066.49	45.99	274 Skagit River	BakertoConcrete	17.52	43066.49	46.57	274 Skagit River	BakertoConcrete	17.52	43066.49	47.43
275 Skagit River	BakertoConcrete	17.08	40745.13	45.33	275 Skagit River	BakertoConcrete	17.08	40745.13	45.87	275 Skagit River	BakertoConcrete	17.08	40745.13	46.64
276 Skagit River	BakertoConcrete	17.07	40656.31	45.3	276 Skagit River	BakertoConcrete	17.07	40656.31	45.84	276 Skagit River	BakertoConcrete	17.07	40656.31	46.61
277 Skagit River	BakertoConcrete	17.05	40555.92	45.2	277 Skagit River	BakertoConcrete	17.05	40555.92	45.73	277 Skagit River	BakertoConcrete	17.05	40555.92	46.48
278 Skagit River	BakertoConcrete	17.04	40295.65	45.08	278 Skagit River	BakertoConcrete	17.04	40295.65	45.6	278 Skagit River	BakertoConcrete	17.04	40295.65	46.34
279 Skagit River	BakertoConcrete	16.82	39443.78	44.68	279 Skagit River	BakertoConcrete	16.82	39443.78	45.17	279 Skagit River	BakertoConcrete	16.82	39443.78	45.85
280 Skagit River	BakertoConcrete	16.81	39295.62	44.63	280 Skagit River	BakertoConcrete	16.81	39295.62	45.12	280 Skagit River	BakertoConcrete	16.81	39295.62	45.79
281 Skagit River	BakertoConcrete	16.79	39221.33	44.55	281 Skagit River	BakertoConcrete	16.79	39221.33	45.03	281 Skagit River	BakertoConcrete	16.79	39221.33	45.68
282 Skagit River	BakertoConcrete	16.78	39082.17	44.5	282 Skagit River	BakertoConcrete	16.78	39082.17	44.98	282 Skagit River	BakertoConcrete	16.78	39082.17	45.62
283 Skagit River	BakertoConcrete	16.6	37687.63	44.14	283 Skagit River	BakertoConcrete	16.6	37687.63	44.6	283 Skagit River	BakertoConcrete	16.6	37687.63	45.19
284 Skagit River	BakertoConcrete	16.3	36005.3	43.77	284 Skagit River	BakertoConcrete	16.3	36005.3	44.21	284 Skagit River	BakertoConcrete	16.3	36005.3	44.74
285 Skagit River	BakertoConcrete	15.9	34064.28	42.75	285 Skagit River	BakertoConcrete	15.9	34064.28	43.11	285 Skagit River	BakertoConcrete	15.9	34064.28	43.52
286 Skagit River	BakertoConcrete	15.1	30227.87	41.36	286 Skagit River	BakertoConcrete	15.1	30227.87	41.69	286 Skagit River	BakertoConcrete	15.1	30227.87	42.04
287 Skagit River	BakertoConcrete	14.6	28627.57	40.97	287 Skagit River	BakertoConcrete	14.6	28627.57	41.32	287 Skagit River	BakertoConcrete	14.6	28627.57	41.72
288 Skagit River	BakertoConcrete	14	25634.75	39.51	288 Skagit River	BakertoConcrete	14	25634.75	39.84	288 Skagit River	BakertoConcrete	14	25634.75	40.22
289 Skagit River	BakertoConcrete	13.8	23448.09	38.48	289 Skagit River	BakertoConcrete	13.8	23448.09	38.78	289 Skagit River	BakertoConcrete	13.8	23448.09	39.1
290 Skagit River	BakertoConcrete	13.1	19253.37	38.03	290 Skagit River	BakertoConcrete	13.1	19253.37	38.33	290 Skagit River	BakertoConcrete	13.1	19253.37	38.67
291 Skagit River	BakertoConcrete	13.05	18903.37	37.96	291 Skagit River	BakertoConcrete	13.05	18903.37	38.26	291 Skagit River	BakertoConcrete	13.05	18903.37	38.6
292 Skagit River	BakertoConcrete	13	17985.61	37.02	292 Skagit River	BakertoConcrete	13	17985.61	37.29	292 Skagit River	BakertoConcrete	13	17985.61	37.6
293 Skagit River	BakertoConcrete	12.96	17407.21	36.58	293 Skagit River	BakertoConcrete	12.96	17407.21	36.82	293 Skagit River	BakertoConcrete	12.96	17407.21	37.11
294 Skagit River	BakertoConcrete	12.95	17379.24	36.56	294 Skagit River	BakertoConcrete	12.95	17379.24	36.81	294 Skagit River	BakertoConcrete	12.95	17379.24	37.09
295 Skagit River	BakertoConcrete	12.93	17346.46	36.23	295 Skagit River	BakertoConcrete	12.93	17346.46	36.46	295 Skagit River	BakertoConcrete	12.93	17346.46	36.72
296 Skagit River	BakertoConcrete	12.92	17308.49	36.2	296 Skagit River	BakertoConcrete	12.92	17308.49	36.43	296 Skagit River	BakertoConcrete	12.92	17308.49	36.69
297 Skagit River	BakertoConcrete	12.4	15062.2	35.41	297 Skagit River	BakertoConcrete	12.4	15062.2	35.62	297 Skagit River	BakertoConcrete	12.4	15062.2	35.86
298 Skagit River	BakertoConcrete	11.7	11545.08	34.09	298 Skagit River	BakertoConcrete	11.7	11545.08	34.27	298 Skagit River	BakertoConcrete	11.7	11545.08	34.46
299 Skagit River	BakertoConcrete	11.2	8790.98	33.02	299 Skagit River	BakertoConcrete	11.2	8790.98	33.19	299 Skagit River	BakertoConcrete	11.2	8790.98	33.37
300 Skagit River	BakertoConcrete	10.6	6829.8	31.65	300 Skagit River	BakertoConcrete	10.6	6829.8	31.8	300 Skagit River	BakertoConcrete	10.6	6829.8	31.96
301 Skagit River	BakertoConcrete	10.55	6476.38	31.58	301 Skagit River	BakertoConcrete	10.55	6476.38	31.73	301 Skagit River	BakertoConcrete	10.55	6476.38	31.89
302 Skagit River	BakertoConcrete	10.51	6192.5	31.16	302 Skagit River	BakertoConcrete	10.51	6192.5	31.3	302 Skagit River	BakertoConcrete	10.51	6192.5	31.45
303 Skagit River	BakertoConcrete	10.45	5737.76	31.02	303 Skagit River	BakertoConcrete	10.45	5737.76	31.15	303 Skagit River	BakertoConcrete	10.45	5737.76	31.3
304 Skagit River	BakertoConcrete	10.39	5327.84	31.04	304 Skagit River	BakertoConcrete	10.39	5327.84	31.18	304 Skagit River	BakertoConcrete	10.39	5327.84	31.33
305 Skagit River	BakertoConcrete	10.35	5002.42	30.82	305 Skagit River	BakertoConcrete	10.35	5002.42	30.96	305 Skagit River	BakertoConcrete	10.35	5002.42	31.1
306 Skagit River	BakertoConcrete	10.31	4725.64	30.68	306 Skagit River	BakertoConcrete	10.31	4725.64	30.81	306 Skagit River	BakertoConcrete	10.31	4725.64	30.95
307 Skagit River	BakertoConcrete	10.28	4499.12	30.56	307 Skagit River	BakertoConcrete	10.28	4499.12	30.69	307 Skagit River	BakertoConcrete	10.28	4499.12	30.83
308 Skagit River	BakertoConcrete	10.23	4167.81	30.25	308 Skagit River	BakertoConcrete	10.23	4167.81	30.37	308 Skagit River	BakertoConcrete	10.23	4167.81	30.51
309 Skagit River	BakertoConcrete	10.18	3776.37	30.19	309 Skagit River	BakertoConcrete	10.18	3776.37	30.31	309 Skagit River	BakertoConcrete	10.18	3776.37	30.45
310 Skagit River	BakertoConcrete	10.14	3532.63	29.95	310 Skagit River	BakertoConcrete	10.14	3532.63	30.07	310 Skagit River	BakertoConcrete	10.14	3532.63	30.2
311 Skagit River	BakertoConcrete	10.1	3237.03	29.83	311 Skagit River	BakertoConcrete	10.1	3237.03	29.95	311 Skagit River	BakertoConcrete	10.1	3237.03	30.08
312 Skagit River	BakertoConcrete	10.06	3042	29.82	312 Skagit River	BakertoConcrete	10.06	3042	29.94	312 Skagit River	BakertoConcrete	10.06	3042	30.07
313 Skagit River	BakertoConcrete	10.02	2805.52	29.89	313 Skagit River	BakertoConcrete	10.02	2805.52	30.01	313 Skagit River	BakertoConcrete	10.02	2805.52	30.14
314 Skagit River	BakertoConcrete	9.97	2555.77	29.98	314 Skagit River	BakertoConcrete	9.97	2555.77	30.11	314 Skagit River	BakertoConcrete	9.97	2555.77	30.24
315 Skagit River	BakertoConcrete	9.9	2161.04	29.79	315 Skagit River	BakertoConcrete	9.9	2161.04	29.91	315 Skagit River	BakertoConcrete	9.9	2161.04	30.04
316 Skagit River	BakertoConcrete	9.76	1425.73	29.63	316 Skagit River	BakertoConcrete	9.76	1425.73	29.75	316 Skagit River	BakertoConcrete	9.76	1425.73	29.88
317 Skagit River	BakertoConcrete	9.62	731.26	29.5	317 Skagit River	BakertoConcrete	9.62	731.26	29.62	317 Skagit River	BakertoConcrete	9.62	731.26	29.75
318 Skagit River	BakertoConcrete	9.56	370.98	29.41	318 Skagit River	BakertoConcrete	9.56	370.98	29.53	318 Skagit River	BakertoConcrete	9.56	370.98	29.65
319 Skagit River	BakertoConcrete	9.49	20	29.31	319 Skagit River	BakertoConcrete	9.49	20	29.43	319 Skagit River	BakertoConcrete	9.49	20	29.55
320 Skagit River	BakertoConcrete	9.48	0	29.3	320 Skagit River	BakertoConcrete	9.48	0	29.42	320 Skagit River	BakertoConcrete	9.48	0	29.55

Water Surface Elevation Profile Graph for Levee Raise

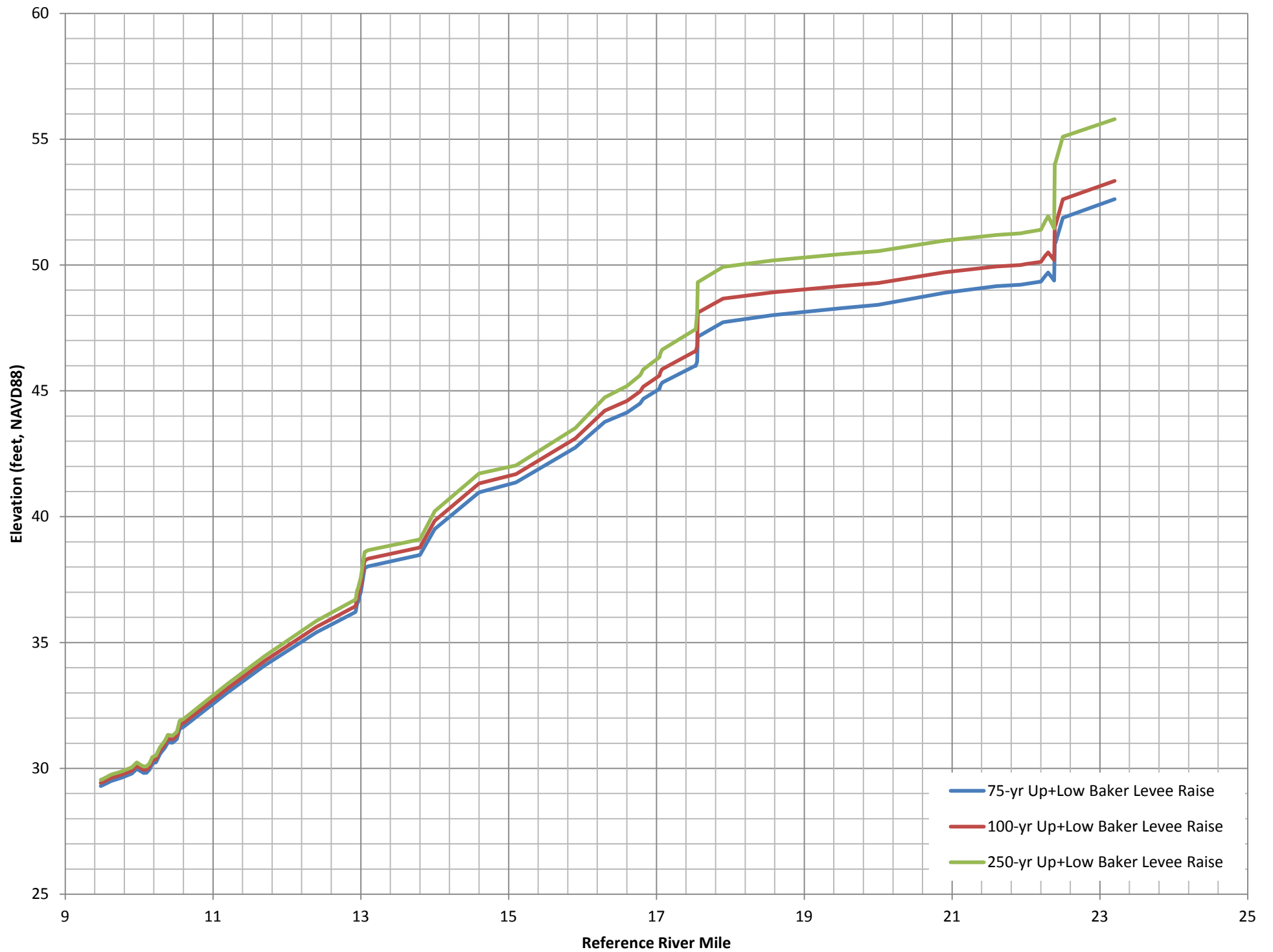

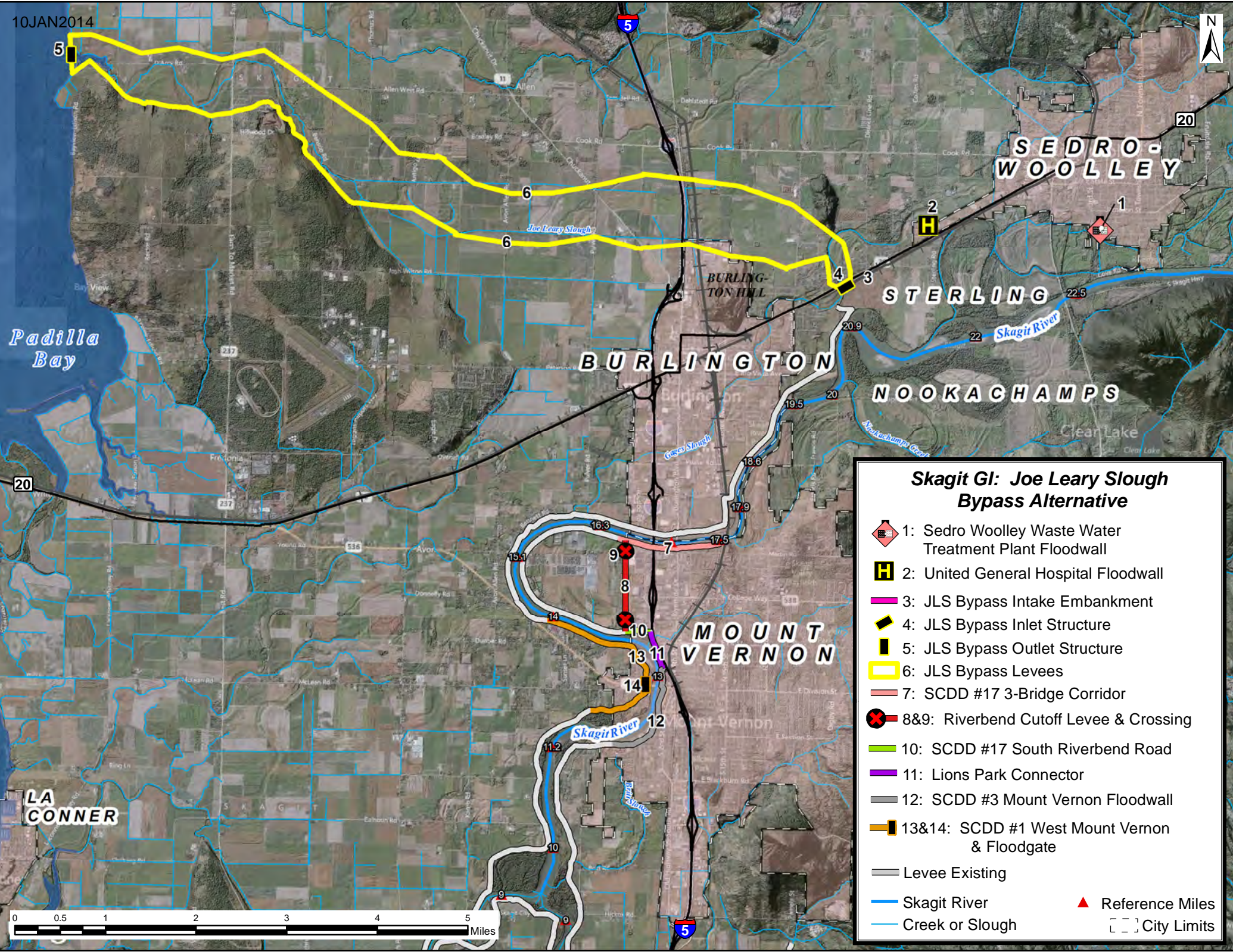

Skagit GI: Joe Leary Slough Bypass Alternative

- 1: Sedro Woolley Waste Water Treatment Plant Floodwall
- 2: United General Hospital Floodwall
- 3: JLS Bypass Intake Embankment
- 4: JLS Bypass Inlet Structure
- 5: JLS Bypass Outlet Structure
- 6: JLS Bypass Levees
- 7: SCDD #17 3-Bridge Corridor
- 8&9: Riverbend Cutoff Levee & Crossing
- 10: SCDD #17 South Riverbend Road
- 11: Lions Park Connector
- 12: SCDD #3 Mount Vernon Floodwall
- 13&14: SCDD #1 West Mount Vernon & Floodgate
- Levee Existing
- Skagit River
- Creek or Slough
- Reference Miles
- City Limits

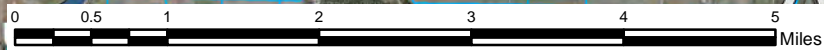

Joe Leary Slough Bypass

Date Modified:

5/20/2013

Segment 1 - U/S Inlet from Skagit River

	Length Total (miles)	Length (miles)	Length (feet)	Height (average, feet)	Slope (xH:1V)	*Volume (FT ³)	*Volume (YD ³)
Wide	10.4	3.6	19,008	10	3	15,966,720	591,360

Segment 2 - midway in bypass channel

	Length (miles)	Length (feet)	Height (average, feet)	Slope (xH:1V)	*Volume (FT ³)	*Volume (YD ³)
	5.2	27456	17	3	58,810,752	2,178,176

Segment 3 - D/S Outlet to Bay

	Length (miles)	Height (average, feet)
	1.6	0

TOTAL VOLUME**

Total Volume (FT ³)	Total Volume (YD ³)	Total Volume Gravel (YD ³)	Total Area (acres)
74,777,472	2,769,536	20651	270.5455

*Note: Volumes doubled to account for both left and right banks of the bypass

Only "wide" configuration analysed as prelim ballpark quantity.

**This does NOT include additional levee raise materials as required



10JAN2014

Padilla Bay

SEDRO-WOOLLEY

STERLING

BURLINGTON

NOOKACHAMPS

CLEAR LAKE

MOUNT VERNON

LA CONNER

FIR ISLAND



Skagit Gl: Swinomish Bypass Alternative

- 1: Sedro Woolley Waste Water Treatment Plant Floodwall
- 2: United General Hospital Floodwall
- 3&4: Burlington Hill Cross Levee, Crossing, Floodgate & RR Gate
- 5: SCDD #12 Upstream
- 6: SCDD #12 BNSF Embank. & RR Gate
- 7: SCDD #17 3-Bridge Corridor
- 8: Swinomish Bypass Intake Structure
- 9: Swinomish Bypass Outlet Structure
- 10: Swinomish Bypass Levees
- 11: Proposed Puget Sound Nearshore Project Restoration Area
- 12: Swinomish Bypass Sea Dikes
- 13: SCDD #17 South Riverbend Road
- 14: Lions Park Connector
- 15: SCDD #3 Mount Vernon Floodwall
- Levee Existing
- Skagit River
- Creek or Slough
- Reference Miles
- City Limits

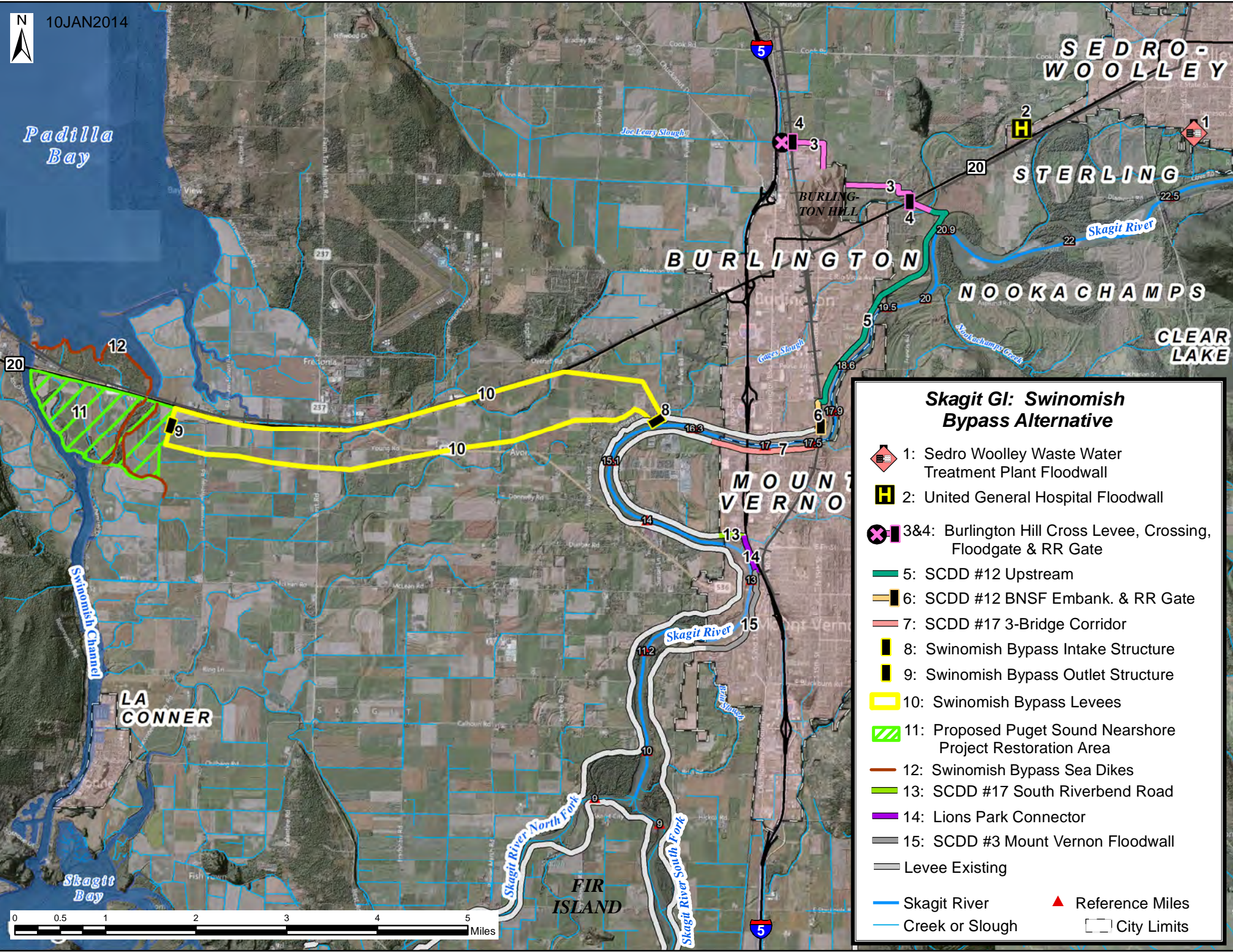

Swinomish Bypass
Date Modified:
5/20/2013

Segment 1

Segment 2

Outlet
Segment 3 - NO LEVEE

TOTAL VOLUME**

	Length		Height		Slope (xH:1V)	*Volume (FT ³)	*Volume (YD ³)	Length		Height		Slope (xH:1V)	*Volume (FT ³)	*Volume (YD ³)	Length		Height		Slope (xH:1V)	*Volume (FT ³)	*Volume (YD ³)	Length (miles)	Height (average, feet)	Total Volume (FT ³)	Total Volume (YD ³)	Total Volume Gravel (YD ³)	Total Area (acres)
	Total (miles)	Length (miles)	Length (feet)	(average, feet)				Length (miles)	Length (feet)	(average, feet)	Length (miles)				Length (feet)	(average, feet)											
1 Narrow	9	5.8	30,624	21	3	96,465,600	3,572,800	1.2	6336	10	3	5,322,240	197,120	2	0												
2 Wide	9	5.8	30,624	18	3	72,762,624	2,694,912	1.2	6336	10	3	5,322,240	197,120	2	0												

***Note: Volumes doubled to account for both left and right banks of the bypass**
Wide channel configuration was chosen by PDT as preferred variant.

**This does NOT include additional levee raise materials as required

FLOOD PROTECTION PROJECT
 SKAGIT RIVER BASIN
 MOUNT VERNON, WASHINGTON

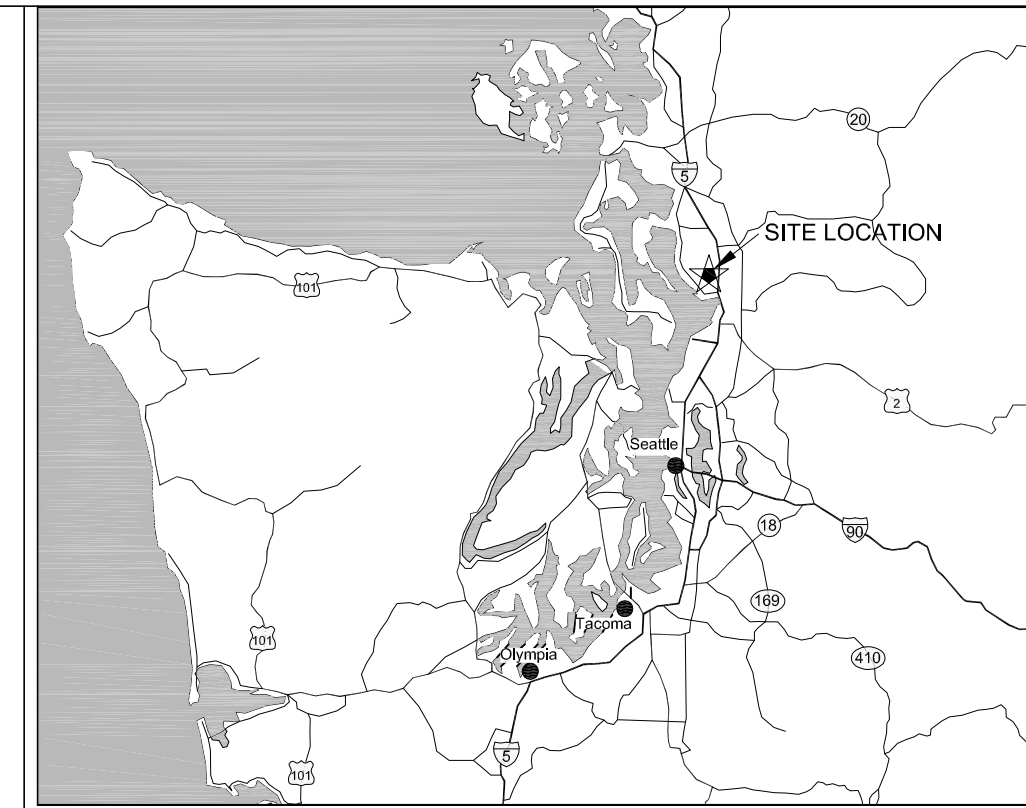

MOUNT VERNON, WASHINGTON

SKAGIT RIVER LEVEE SYSTEM CITY OF MOUNT VERNON - DOWNTOWN FLOOD PROTECTION PROJECT

DESIGNED BY	AL	01/30/2009			
ENTERED BY	WN	01/30/2009			
CHECKED BY	JJ	01/30/2009			JOB NUMBER 1602C
PROJ. ENGR.	AL	01/30/2009			CONTRACT NO.
	DATE	DATE	REVISION	BY	

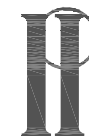

PACIFIC
 INTERNATIONAL
 ENGINEERING, PLLC

501 Columbia Street NW
 Suite D
 Olympia, WA 98501
 Phone (360) 352-2232
 Fax (360) 352-6525

CITY OF MOUNT VERNON
 DOWNTOWN FLOOD PROTECTION PROJECT
 MOUNT VERNON, WA
 COVER SHEET

REFERENCE
 SHEET
 NUMBER
 A-1
 SHEET
 1
 OF
 38
 SHEETS

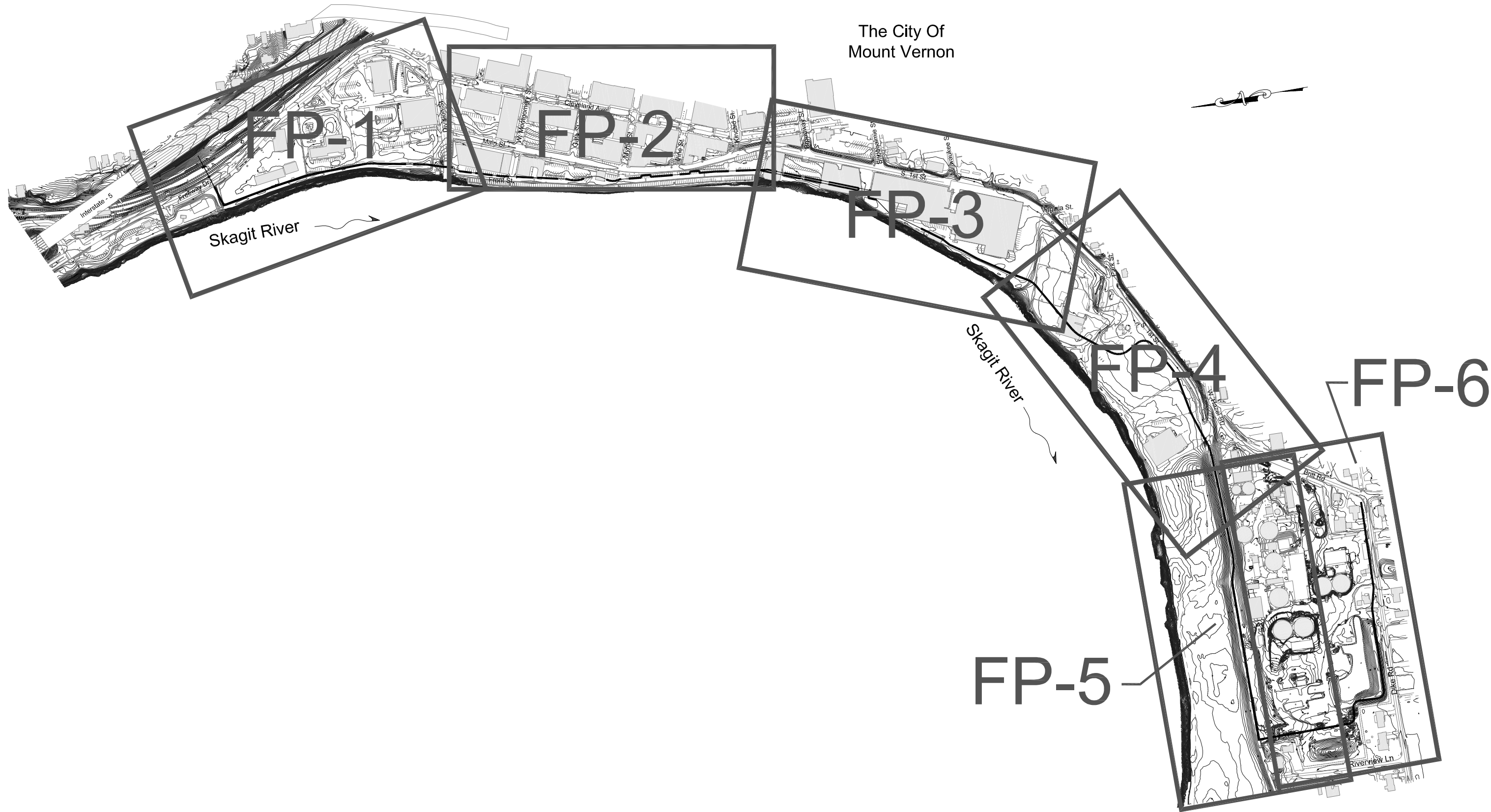

The City Of
Mount Vernon

Skagit River

Skagit River

FP-1

FP-2

FP-3

FP-4

FP-5

FP-6

DESIGNED BY	AL	01/30/2009			
ENTERED BY	WN	01/30/2009			
CHECKED BY	JJ	01/30/2009			JOB NUMBER 1602C
PROJ. ENGR.	AL	01/30/2009			CONTRACT NO.
	DATE	DATE	REVISION	BY	

PACIFIC
INTERNATIONAL
ENGINEERING, LLC

501 Columbia Street NW
Suite D
Olympia, WA 98501
Phone (360) 352-2232
Fax (360) 352-6525

CITY OF MOUNT VERNON
DOWNTOWN FLOOD PROTECTION PROJECT
MOUNT VERNON, WA
SITE MAP

REFERENCE SHEET NUMBER	A-3
SHEET OF SHEETS	3 OF 38



DESIGNED BY	AL	01/30/2009			
ENTERED BY	WN	01/30/2009			
CHECKED BY	JJ	01/30/2009			
PROJ. ENGR.	AL	01/30/2009			
	DATE	DATE	REVISION	BY	

JOB NUMBER
1602C
CONTRACT NO.



PACIFIC INTERNATIONAL ENGINEERING, PLLC.
 501 Columbia Street NW
 Suite D
 Olympia, WA 98501
 Phone (360) 352-2232
 Fax (360) 352-6525

CITY OF MOUNT VERNON
 DOWNTOWN FLOOD PROTECTION PROJECT
 MOUNT VERNON, WA
 PLAN -- STA 0+00 TO STA 14+00

REFERENCE SHEET NUMBER
FP-1
SHEET 10 OF 38 SHEETS



Skagit River →

DESIGNED BY	AL	01/30/2009		
ENTERED BY	WN	01/30/2009		
CHECKED BY	JJ	01/30/2009		
PROJ. ENGR.	AL	01/30/2009		
	DATE	DATE	REVISION	BY

JOB NUMBER
1602C
CONTRACT NO.



PACIFIC INTERNATIONAL ENGINEERING, PLLC

501 Columbia Street NW
Suite D
Olympia, WA 98501
Phone (360) 352-2232
Fax (360) 352-6525

CITY OF MOUNT VERNON
DOWNTOWN FLOOD PROTECTION PROJECT
MOUNT VERNON, WA
PLAN -- STA 14+00 TO STA 28+00

REFERENCE SHEET NUMBER
FP-2
SHEET 11 OF 38 SHEETS

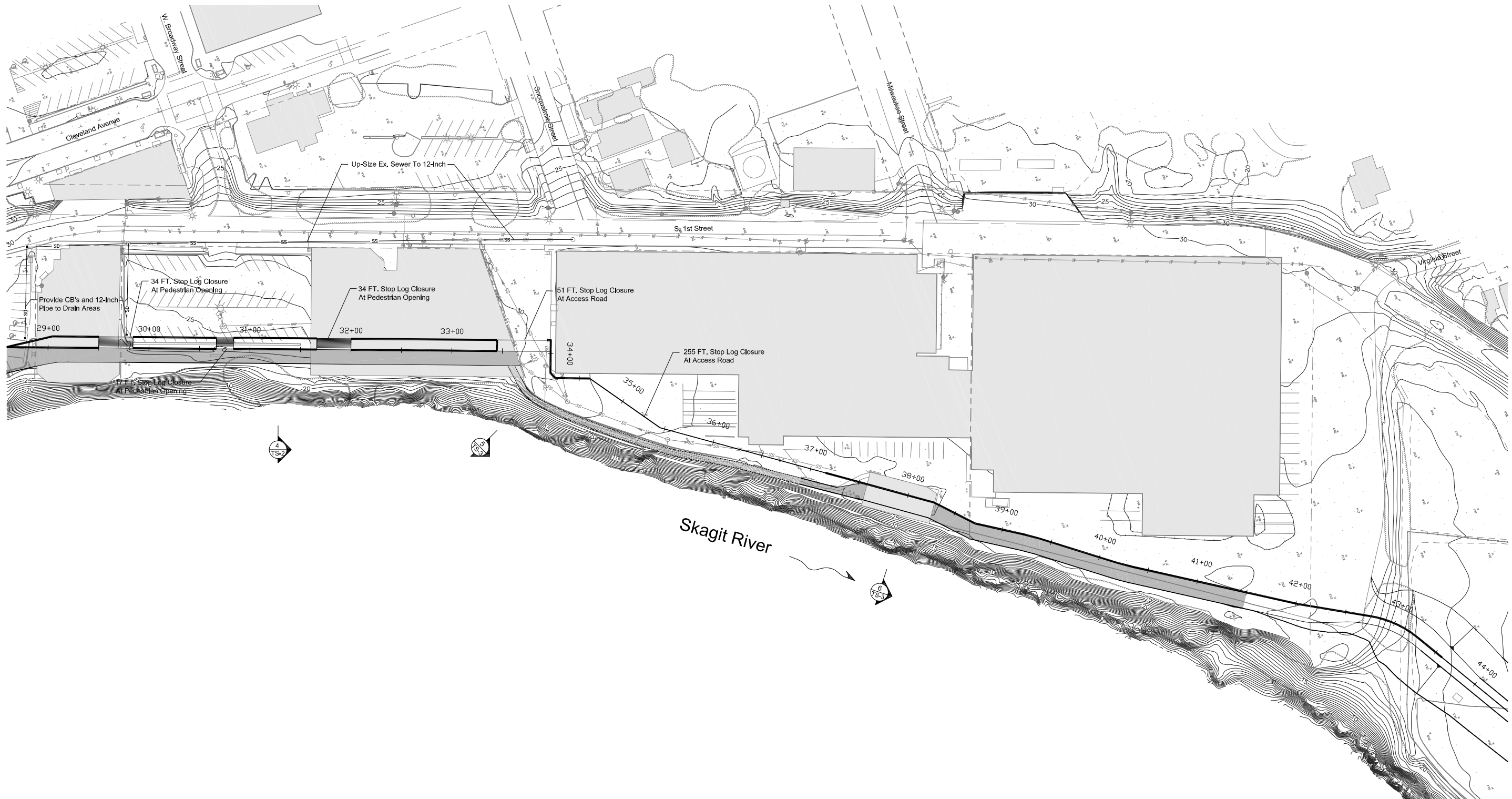

DESIGNED BY	AL	01/30/2009			
ENTERED BY	WN	01/30/2009			
CHECKED BY	JJ	01/30/2009			JOB NUMBER 1602C
PROJ. ENGR.	AL	01/30/2009			CONTRACT NO.
	DATE	DATE	REVISION	BY	



PACIFIC INTERNATIONAL ENGINEERING PLLC
 501 Columbia Street NW
 Suite D
 Olympia, WA 98501
 Phone (360) 352-2232
 Fax (360) 352-6525

CITY OF MOUNT VERNON
 DOWNTOWN FLOOD PROTECTION PROJECT
 MOUNT VERNON, WA

PLAN -- STA 28+00 TO STA 43+00

REFERENCE SHEET NUMBER	FP-3
SHEET OF SHEETS	12 OF 38



DESIGNED BY	AL	01/30/2009			
ENTERED BY	WN	01/30/2009			
CHECKED BY	JJ	01/30/2009			
PROJ. ENGR.	AL	01/30/2009			
	DATE	DATE	REVISION	BY	

JOB NUMBER
1602C
CONTRACT NO.

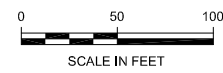

PACIFIC INTERNATIONAL ENGINEERING, PLLC
 501 Columbia Street NW
 Suite D
 Olympia, WA 98501
 Phone (360) 352-2232
 Fax (360) 352-6525

CITY OF MOUNT VERNON
 DOWNTOWN FLOOD PROTECTION PROJECT
 MOUNT VERNON, WA
 PLAN -- STA 43+00 TO STA 58+00

REFERENCE SHEET NUMBER
FP-4
SHEET 13 OF 38 SHEETS



Skagit River →

DESIGNED BY	AL	01/30/2009			
ENTERED BY	WN	01/30/2009			
CHECKED BY	JJ	01/30/2009			
PROJ. ENGR.	AL	01/30/2009			
	DATE	DATE	REVISION	BY	

JOB NUMBER
1602C
CONTRACT NO.



P PACIFIC INTERNATIONAL ENGINEERING, PLLC
 501 Columbia Street NW
 Suite D
 Olympia, WA 98501
 Phone (360) 352-2232
 Fax (360) 352-6525

CITY OF MOUNT VERNON
 DOWNTOWN FLOOD PROTECTION PROJECT
 MOUNT VERNON, WA
 PLAN -- STA 58+00 TO STA 72+00

REFERENCE SHEET NUMBER
FP-5
SHEET 14 OF 38 SHEETS

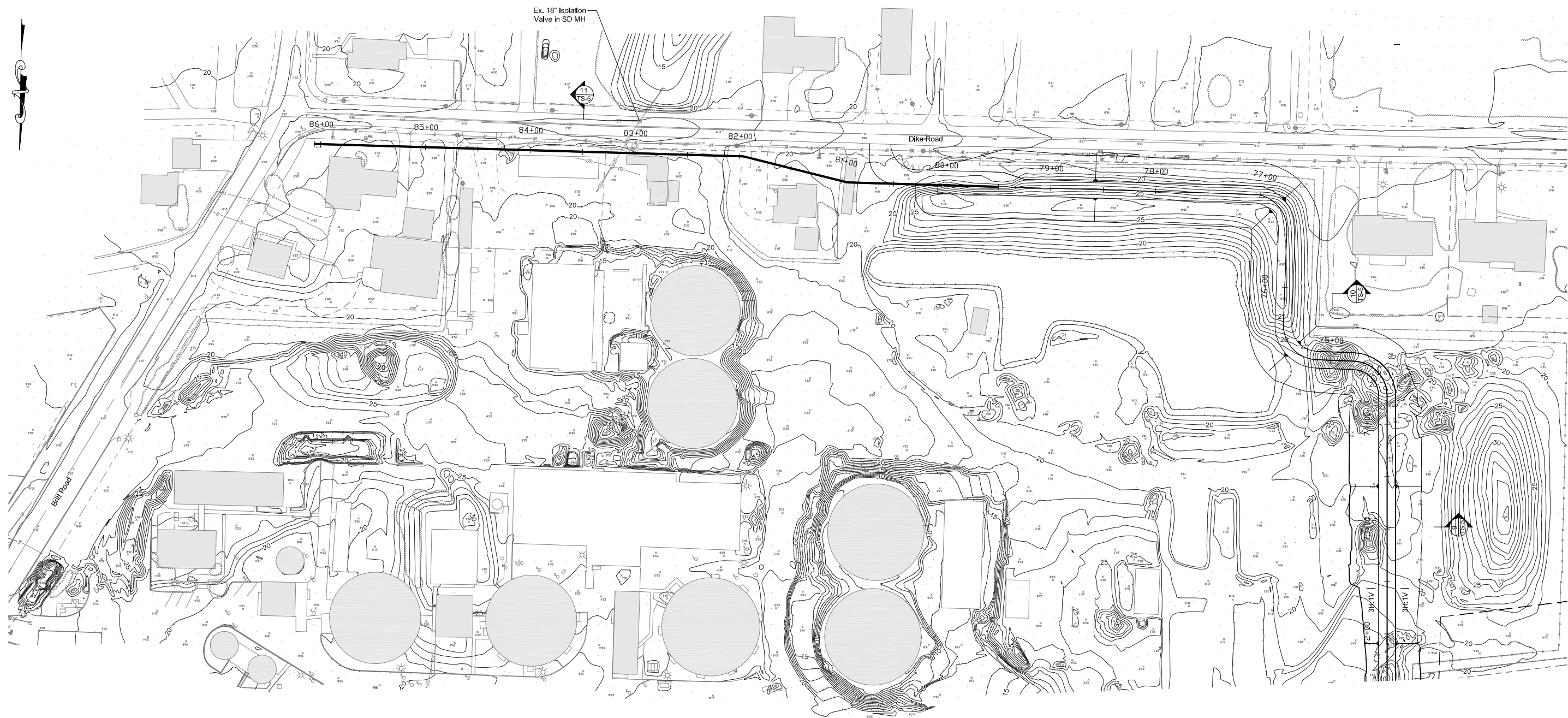

DESIGNED BY	AL	01/30/2009			
ENTERED BY	WN	01/30/2009			
CHECKED BY	JJ	01/30/2009			
PROJ. ENGR.	AL	01/30/2009			
	DATE	DATE	REVISION	BY	

JOB NUMBER
1602C
CONTRACT NO.

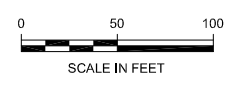

PACIFIC INTERNATIONAL ENGINEERING, LLC.
 501 Columbia Street NW
 Suite D
 Olympia, WA 98501
 Phone (360) 352-2232
 Fax (360) 352-6525

CITY OF MOUNT VERNON
 DOWNTOWN FLOOD PROTECTION PROJECT
 MOUNT VERNON, WA
 PLAN -- STA 72+00 TO STA 86+00

REFERENCE SHEET NUMBER
FP-6
SHEET 15 OF 38 SHEETS

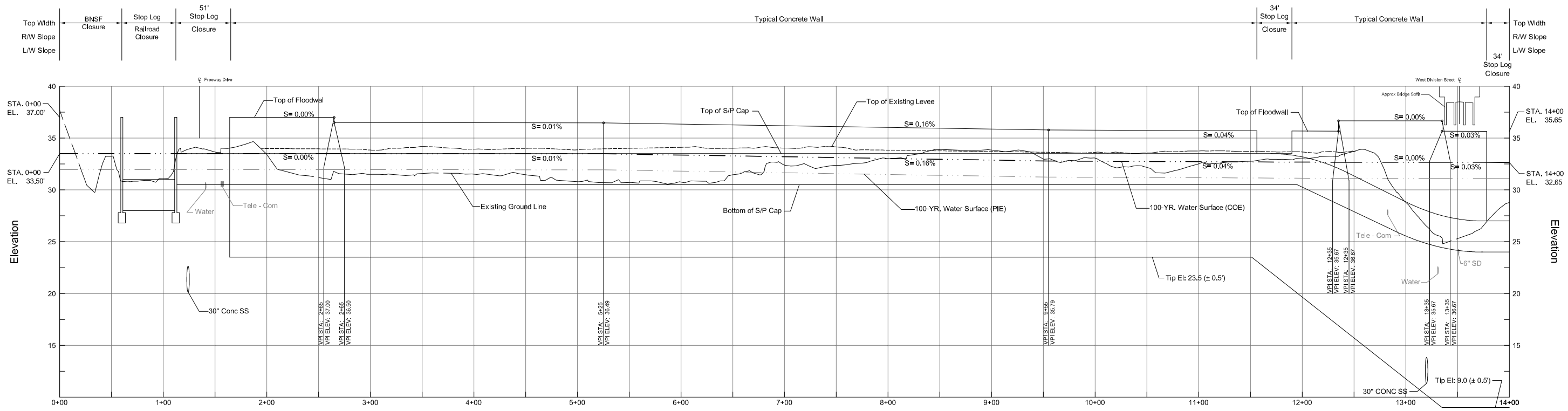

Profile

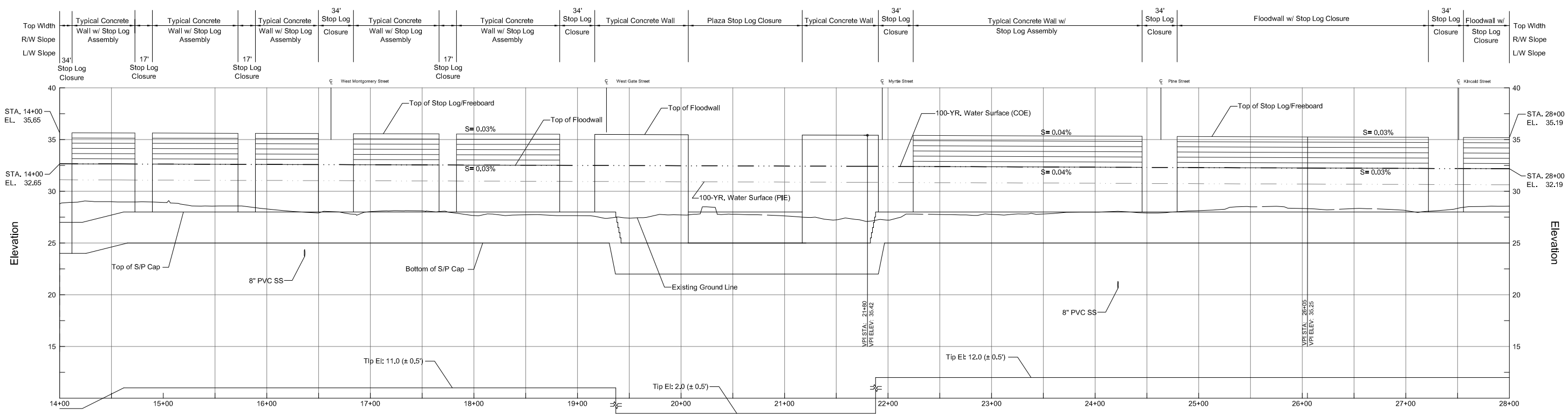

Profile

DESIGNED BY	AL	01/30/2009		
ENTERED BY	WN	01/30/2009		
CHECKED BY	JJ	01/30/2009		
PROJ. ENGR.	AL	01/30/2009		
	DATE	DATE	REVISION	BY

JOB NUMBER
1602C
CONTRACT NO.

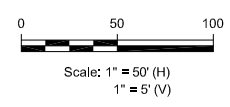

PACIFIC INTERNATIONAL ENGINEERING, PLLC
 501 Columbia Street NW
 Suite D
 Olympia, WA 98501
 Phone (360) 352-2232
 Fax (360) 352-5525

CITY OF MOUNT VERNON
 DOWNTOWN FLOOD PROTECTION PROJECT
 MOUNT VERNON, WA
PROFILE - STA 0+00 TO STA 28+00

REFERENCE SHEET NUMBER
FP-7
 SHEET
 16
 OF
 38
 SHEETS

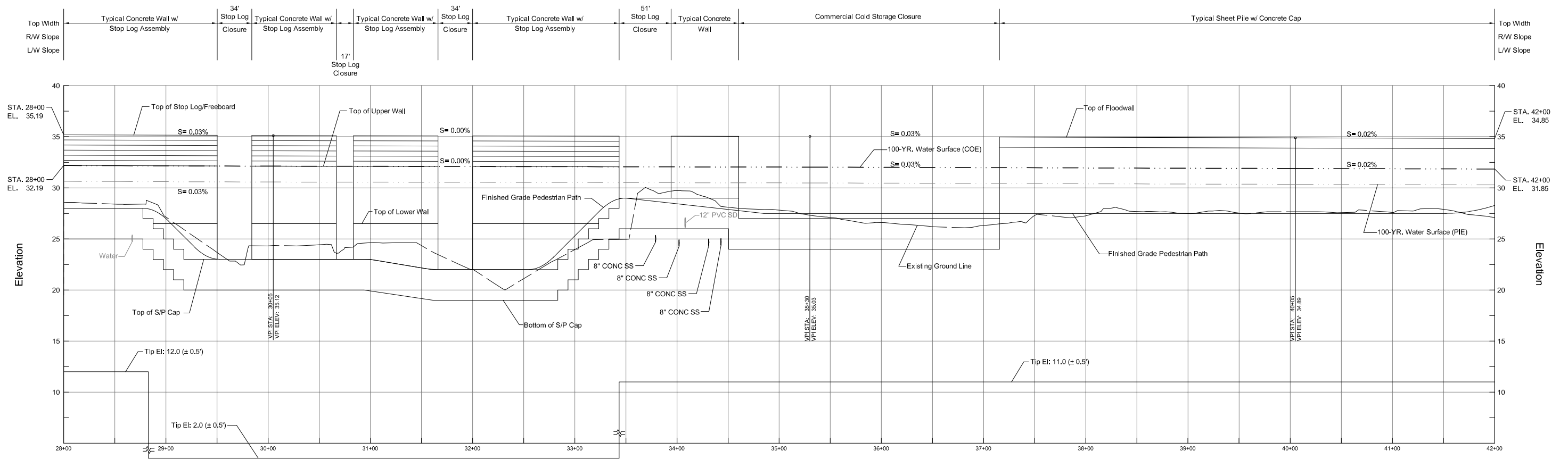

Profile

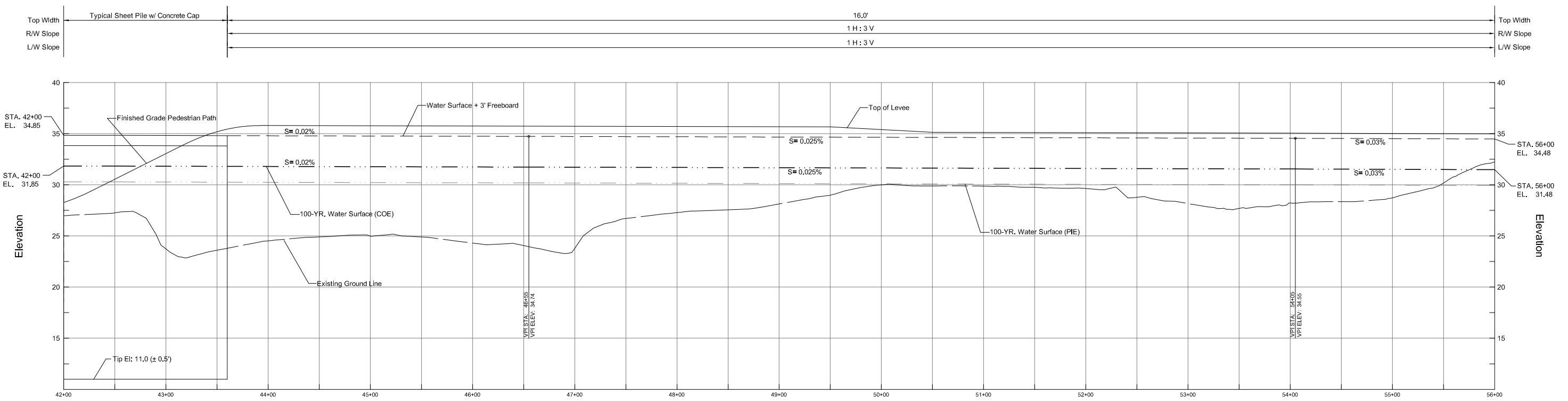

Profile

DESIGNED BY	AL	01/30/2009		
ENTERED BY	WN	01/30/2009		
CHECKED BY	JJ	01/30/2009		
PROJ. ENGR.	AL	01/30/2009		
	DATE	DATE	REVISION	BY

JOB NUMBER
1602C
CONTRACT NO.

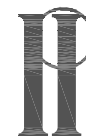
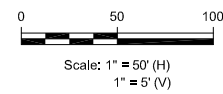

PACIFIC INTERNATIONAL ENGINEERING, LLC

501 Columbia Street NW
Suite D
Olympia, WA 98501
Phone (360) 352-2232
Fax (360) 352-6525

CITY OF MOUNT VERNON
DOWNTOWN FLOOD PROTECTION PROJECT
MOUNT VERNON, WA
PROFILE - STA 28+00 TO STA 56+00

REFERENCE SHEET NUMBER
FP-8
SHEET 17 OF 38 SHEETS

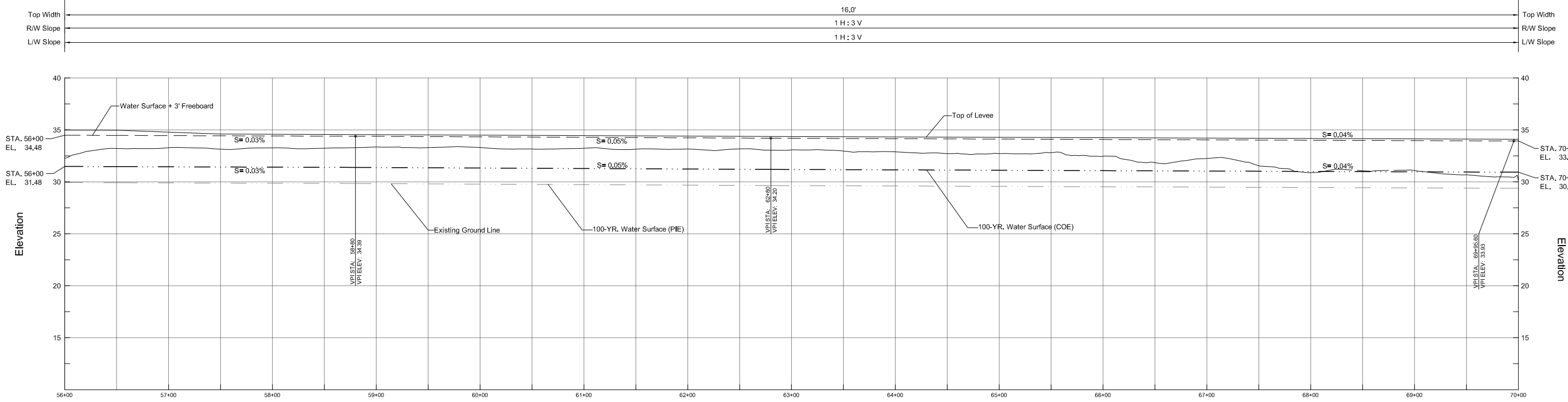

Profile

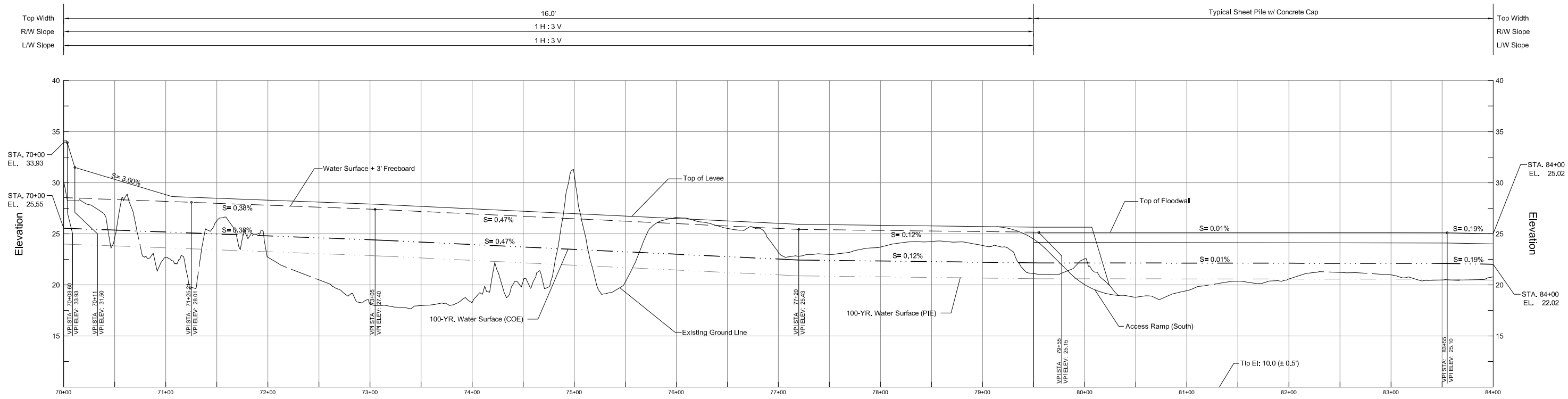

Profile

DESIGNED BY	AL	01/30/2009		
ENTERED BY	WN	01/30/2009		
CHECKED BY	JJ	01/30/2009		
PROJ. ENGR.	AL	01/30/2009		
	DATE	DATE	REVISION	BY

JOB NUMBER
1602C
CONTRACT NO.

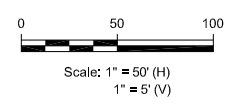

PACIFIC INTERNATIONAL ENGINEERING, LLC
501 Columbia Street NW
Suite D
Olympia, WA 98501
Phone (360) 352-2232
Fax (360) 352-5525

CITY OF MOUNT VERNON
DOWNTOWN FLOOD PROTECTION PROJECT
MOUNT VERNON, WA
PROFILE - STA 56+00 TO STA 84+00

REFERENCE SHEET NUMBER
FP-9
SHEET 18 OF 38 SHEETS

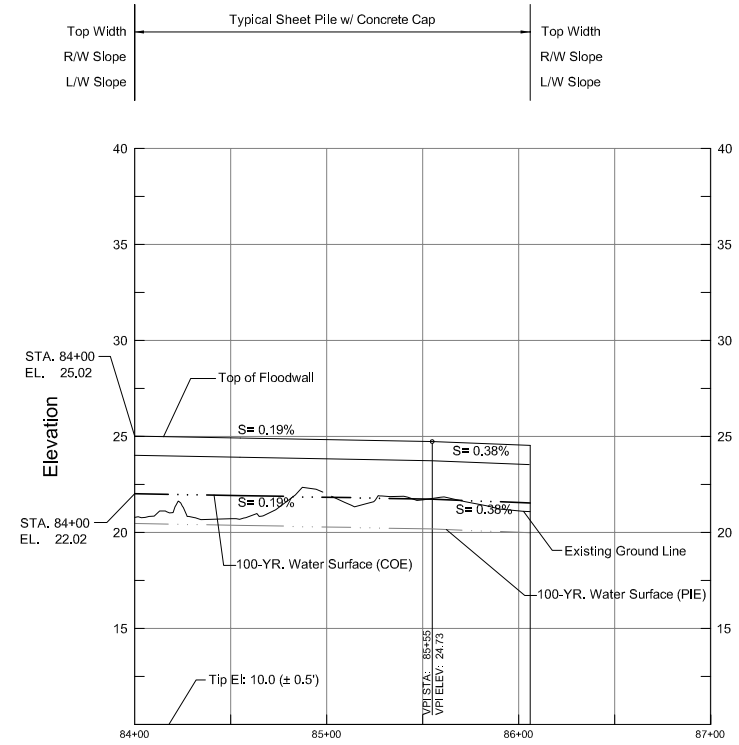

Profile

DESIGNED BY	AL	01/30/2009		
ENTERED BY	WN	01/30/2009		
CHECKED BY	JJ	01/30/2009		
PROJ. ENGR.	AL	01/30/2009		
	DATE	DATE	REVISION	BY

JOB NUMBER
1602C
CONTRACT NO.

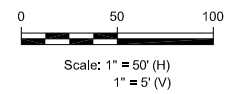

PACIFIC INTERNATIONAL ENGINEERING, LLC
501 Columbia Street NW
Suite D
Olympia, WA 98501
Phone (360) 352-2232
Fax (360) 352-6525

CITY OF MOUNT VERNON
DOWNTOWN FLOOD PROTECTION PROJECT
MOUNT VERNON, WA
PROFILE - STA 84+00 TO STA 86+00

REFERENCE SHEET NUMBER
FP-10
SHEET 19 OF 38 SHEETS

**Skagit River Levee General Investigation (GI)
Levee Risk and Reliability Analysis
Skagit County, Washington**

January 31, 2011

Submitted To:
USACE, Seattle District
Attn: Mr. Daniel E. Johnson
4735 East Marginal Way South
Seattle, Washington 98134

By:
Shannon & Wilson, Inc.
400 N 34th Street, Suite 100
Seattle, Washington 98103

21-1-21199-003

TABLE OF CONTENTS

	Page
1.0 INTRODUCTION	1
2.0 DATA AND DATA SOURCES	2
3.0 LEVEE CROSS SECTIONS	2
3.1 Ground Surface Profile	3
3.2 Subsurface Profile	3
3.3 Bathymetry	4
4.0 POTENTIAL FAILURE MODES	4
4.1 Quantifiable Failure Modes	6
4.1.1 Underseepage	6
4.1.2 Riverside and Landside Static Slope Failure	6
4.1.3 Riverside and Landside Seismic Slope Failure	7
4.1.4 Riverside Slope Failure Due to Rapid Drawdown	7
4.2 Other Failure Modes	7
4.2.1 Liquefaction	7
4.2.2 Throughseepage	8
4.2.3 Scour	8
4.2.4 Sequential Failure	8
4.3 Other Failure Mode Factors and Uncertainties	8
4.3.1 River Stage Duration	9
4.3.2 Length Effect	9
4.3.3 Channel Configuration	9
4.3.4 Non-Levee Structures	10
4.3.5 Surface Elevation Uncertainty	10
4.3.6 Subsurface Contact Elevation Uncertainty	10
4.3.7 Method Uncertainty	10
5.0 ANALYTICAL METHODS	11
5.1 Underseepage	11
5.1.1 Underseepage Calculation with SEEP/W	12
5.1.2 Underseepage Calculation by USACE EM 1110-2-1913 Method	13
5.2 Slope Stability	13
5.2.1 Slope Stability Calculation with SLOPE/W	13
5.2.2 Static Factor of Safety (FS) Calculations	14
5.2.3 Seismic Factor of Safety (FS) Calculations	15
5.2.4 Rapid Drawdown Factor of Safety (FS) Calculations	16
5.3 Probability of Failure by Taylor Series Method	16
5.4 Probability of Failure by Monte Carlo Method	18
5.5 Scour Probability	19

	Page
5.6 Liquefaction	20
5.7 Throughseepage	21
5.8 Sequential Failure.....	22
6.0 INPUT VARIABLES AND DISTRIBUTIONS.....	23
6.1 Seepage Variables	23
6.2 Slope Stability Variables.....	25
6.3 Scour Probability Variables	25
6.4 Liquefaction Potential Variables.....	26
7.0 RELIABILITY ANALYSIS RESULTS.....	26
7.1 Quantifiable Failure Modes.....	26
7.1.1 Overview.....	26
7.1.2 Underseepage.....	26
7.1.3 Landside Static Failure	27
7.1.4 Riverside Static Failure.....	28
7.1.5 Landside Seismic Failure.....	28
7.1.6 Riverside Seismic Failure.....	29
7.2 Other Failure Modes	29
7.2.1 Liquefaction Potential.....	29
7.2.2 Throughseepage.....	30
7.2.3 Scour Probability	30
7.2.4 Sequential Failure	31
7.2.5 Contribution to Combined Conditional Probability of Failure.....	32
7.3 Other Failure Mode Factors	32
7.3.1 River Stage Duration	32
7.3.2 Length Effect	33
7.3.3 Channel Configuration.....	33
7.3.4 Non-Levee Structures	33
7.3.5 Measurement Uncertainty.....	34
7.3.6 Method Uncertainty	34
8.0 $P_f = 0$ CALIBRATION	35
8.1 Estimate of $P_f = 0$ River Stage	35
8.2 $P_f = 0$ Calibration	36
9.0 FRAGILITY CURVES.....	36
9.1 Fragility Curve Development.....	36
9.2 Fragility Curve Discussion.....	36
10.0 LIMITATIONS.....	38
11.0 REFERENCES.....	39

TABLES

1	Analysis Section Names and River Mile
2	Analysis Section Bathymetric Measurements
3	Summary of Input Variables, Hydraulic Conductivity
4	Summary of Input Variables, Hydraulic Conductivity Ratio
5	Summary of Input Variables, Total Unit Weight
6	Summary of Input Variables, Friction Angle
7	Summary of Input Variables, Scour Probability
8	Liquefaction Threshold Return Period
9	Summary of Monte Carlo Analyses

FIGURES

1	Analysis Cross Section Locations
2	DD1-1R Cross Section
3	DD1-2R Cross Section
4	DD3-1L Cross Section
5	DD17-1L Cross Section
6	DD17-2L Cross Section
7	DD17-3L Cross Section
8	DD22-1R Cross Section
9	DD22-2L Cross Section
10	Bathymetry Measurement and Analysis Locations
11	Skagit River Bathymetry Measurements
12	North Fork Skagit River Bathymetry Measurements
13	South Fork Skagit River Bathymetry Measurements
14	Skagit River Rating Curve and Hydrographs
15	Depth-Normalized Underseepage Failure Probabilities
16	Depth-Normalized Landside Static Failure Probabilities
17	Depth-Normalized Landside Seismic Failure Probabilities
18	Depth-Normalized Riverside Seismic Failure Probabilities
19	Scour Probability vs. Water Depth, Skagit River
20	Scour Probability vs. Water Depth, North and South Fork
21	Sequential Failure Scenario, River Section DD17-1L
22	Length Effect on Conditional Probability of Levee Failure
23	Fragility Curve and Table, Section DD1-1R
24	Fragility Curve and Table, Section DD1-2R
25	Fragility Curve and Table, Section DD3-1L
26	Fragility Curve and Table, Section DD17-1L
27	Fragility Curve and Table, Section DD17-2L
28	Fragility Curve and Table, Section DD17-3L
29	Fragility Curve and Table, Section DD22-1R
30	Fragility Curve and Table, Section DD22-2L

APPENDICES

- A Boring Logs
- B Sample SEEP/W and SLOPE/W Analyses
- C Important Information About Your Geotechnical/Environmental Report

ENCLOSURES

- CD-1 21-1-21199-002.pdf, Geotechnical and Hydrogeologic Data and Liquefaction Evaluation Report in PDF Format
- CD-1 Taylor Series DD1-1R.xlsx, Fragility Curve in Excel Format
- CD-1 Taylor Series DD1-2R.xlsx, Fragility Curve in Excel Format
- CD-1 Taylor Series DD3-1L.xlsx, Fragility Curve in Excel Format
- CD-1 Taylor Series DD17-1L.xlsx, Fragility Curve in Excel Format
- CD-1 Taylor Series DD17-2L.xlsx, Fragility Curve in Excel Format
- CD-1 Taylor Series DD17-3L.xlsx, Fragility Curve in Excel Format
- CD-1 Taylor Series DD22-1R.xlsx, Fragility Curve in Excel Format
- CD-1 Taylor Series DD22-2L.xlsx, Fragility Curve in Excel Format

**SKAGIT RIVER LEVEE GENERAL INVESTIGATION (GI)
LEVEE RISK AND RELIABILITY ANALYSIS
SKAGIT COUNTY, WASHINGTON**

1.0 INTRODUCTION

The Skagit River Levee General Investigation study is part of an effort by the Seattle District U.S. Army Corps of Engineers (USACE) to identify available levee information and to investigate measures to reduce flood impacts along the Skagit River. This report summarizes an analysis of levee risk and reliability at eight locations along the Skagit River.

Shannon & Wilson's (S&W's) services for this analysis were authorized by the USACE under Task Order No. 0013 of Contract No. W912DW-09-D-1005. Our services were performed in general accordance with the Statement of Work for the task order.

The scope of the project was to

- Review available data
- Develop ground surface and subsurface profiles for eight levee cross sections
- Identify potential levee failure modes at each cross section
- Identify an appropriate analysis method for each failure mode
- Identify the critical input variables for each failure mode and develop estimates of the most likely value and standard deviation for each variable
- Estimate the river stage at which the conditional probability of failure (P_f) is zero for calibration of the reliability analysis for each cross section
- Determine an appropriate range of river stages for the reliability analyses for each cross section and failure mode
- Perform the appropriate reliability analysis for each cross section and failure mode
- Calibrate the reliability analyses based on the estimated $P_f = 0$ river stage
- Prepare tables and graphs of levee fragility for each cross section

This report presents the data, assumptions, methods, and results of our levee risk and reliability analysis. Electronic copies of the analysis input files and levee fragility spreadsheets are enclosed with this report.

2.0 DATA AND DATA SOURCES

The data generally required for a levee risk and reliability analysis include levee geometry and material properties, subsurface conditions and material properties, river hydraulic and hydrologic conditions, levee design and construction records, and levee maintenance and performance history. The reliability of the analytical results will depend on the accuracy and completeness of the available data.

The data used to perform the analyses described in this report were drawn from the following sources:

- Report of field explorations and results of field tests performed at the eight levee cross section locations selected for this study
- Results laboratory tests performed on samples obtained from the field investigation of the eight levee locations
- Previous investigations at other locations in the Skagit River levee system
- USACE reports, drawings, and historical data
- Skagit County records
- Supplemental data from the levee analysis and design literature
- Engineering judgment

Additional background information was provided in discussions with personnel from USACE, Skagit County, and Northwest Hydraulic Consultants, Inc. (NHC).

3.0 LEVEE CROSS SECTIONS

The eight levee cross sections used for our risk and reliability analysis are at the locations chosen for exploration and evaluation of subsurface conditions. The locations were selected to coincide with known seepage areas along the levee. The specific boring locations were selected based on the information obtained from our review of existing project data and conversations with the USACE, Skagit County, and Dike Districts 1, 3, 17, and 22. The naming convention used for analyses follows the naming convention of the borings presented in S&W's geotechnical report (Shannon & Wilson, 2010). The analysis section names and river mile locations are shown in Table 1.

The analysis locations are shown in plan view in Figure 1 and the cross section profiles for each location are presented in Figures 2 through 9. Cross section profiles of the levee embankments,

river bathymetry, and foundation soils were developed from information obtained from design and construction drawings (USACE, various), bathymetry data (USACE, 2010, see Figures 10 to 13), subsurface exploration data (Shannon & Wilson, 2010, see Appendix A), and LIDAR and survey data (PSLC, 2003, USACE 2010).

3.1 Ground Surface Profile

Design and construction drawings of the levee embankments were typically for sites other than the specific locations selected for analysis. However, the drawings generally show a levee embankment 10 to 20 feet in height, crest widths of 12 to 16 feet, riverside slopes ranging from 1.5 to 2 horizontal to 1 vertical (1.5 to 2 H:1V), and landside slopes ranging from 2 to 3 H:1V. In some cases, the design and construction drawings also showed riverside or landside berms extending beyond the toe of the levee slopes. Ground surface profiles at the analysis locations were generated from 3-meter LIDAR data and crest survey data provided by the USACE to obtain location-specific profiles. The generated profiles were generally in good agreement with the typical profiles found in the design and construction drawings and were used to develop the analysis section ground surface profiles.

3.2 Subsurface Profile

Subsurface soil contacts in the levee foundation and adjacent soils were developed primarily from boring logs (Appendix A) prepared for the geotechnical report of explorations at the eight analysis locations (Shannon & Wilson, 2010). Boring logs from previous field explorations (USACE various, Golder, 2009) were used to corroborate the conclusions drawn from the site-specific subsurface explorations.

In general, the boring logs indicate that levee foundation soils at the eight locations consist of overbank deposits underlain by channel deposits. Overbank deposits range from 5 to 17 feet thick and generally consist of sands and silts with some clay. The channel deposits range from 4 to 40 feet thick and vary from slightly silty sand and gravel to sandy gravel. Borings that were advanced through the channel deposits indicate that the channel deposits are underlain by soils similar in composition and characteristics to the overbank deposits. Estuary deposits were found in the borings at analysis section DD22-1L near Skagit Bay and consist of silt and fine sand with shell fragments.

Based on our interpretation of the boring log and laboratory data, we generalized the levee foundation soils to a three-layer system consisting of overbank deposits (overbank), channel deposits (pervious layer), and an underlying soil similar to the overbank deposits (sub-layer).

The thicknesses of the overbank and pervious layer at each analysis section were derived from the boring logs at each section. Because only two borings were completed at each location, we assumed a horizontal projection of the subsurface conditions beyond the limits of the boring locations.

Based on visual observation and laboratory test results, the levee embankment materials appear to be predominantly locally obtained from the overbank deposits, although four of the eight borings in the levees encountered clayey soils in the upper 5 to 7 feet of the levee embankment that may be imported from other sources. For purposes of the risk and reliability analyses, the levee embankment materials at all analysis sections were assumed to be constructed of overbank deposit soils.

3.3 Bathymetry

River bathymetric profiles at the analysis locations were developed from bathymetry measurements (USACE, 2010). The locations of the bathymetry measurements relative to the locations of the analysis sections are shown in Figure 10 and the bathymetry measurements nearest to the analysis locations are shown in Figures 11 through 13.

The location of bathymetry measurements coincided with two of the analysis locations; however, the location of bathymetry measurements ranged from approximately 500 to 2,600 feet upstream or downstream for the other six analysis locations. The bathymetric profiles used at each location and the rationale for the selections are summarized in Table 2.

4.0 POTENTIAL FAILURE MODES

Levee failure is generally defined as a failure of the levee to provide the intended protection to the people and property on the landside of the levee. The intended protection is typically defined in terms of a specific return period water level (e.g., protection from a 100-year return period event). Levee fragility curves are a description of the likelihood of levee failure for a range of water levels. Fragility curves can be used to compare different levee designs or locations and provide input to an analysis of levee failure consequences.

An analysis of levee failure consequences typically begins from a fragility curve, but must also consider potential breach characteristics. A breach is generally defined as the opening created after failure of the levee embankment. The depth and width of the breach generally depends on the water level, duration, and levee material properties. Many of the potential levee failure

modes can lead to a levee breach; however, the failure modes most frequently associated with breaches are slope failure and overtopping.

The potential failure modes used for the Skagit River levees risk analysis were identified from a review of historical levee failures, river hydraulic and hydrologic characteristics, levee structural characteristics, and geotechnical characteristics of the levee embankment and foundation soils. Some of the identified failure modes can be analyzed by conventional, quantitative methods to estimate conditional probabilities of failure; and others require qualitative or semi-quantitative approaches to estimate conditional probability of failure. Not all levee failures are equally catastrophic. For example, underseepage failure in the absence of slope failure may not immediately lead to significant flooding. The analysis that is generally performed, however, treats each failure mode equally and may lead to a conservative estimate of the likelihood of levee failure.

The Skagit River levees have experienced a number of failures but evidence of the failure mode for each case is often unavailable. As with most levees, first-hand observation of the Skagit River levee failures is rare and post-failure investigation and analysis are limited by the need for immediate repair and the cost of investigation and analysis. The historical evidence suggests that underseepage and slope failure due to scour and overtopping are the most common levee failure modes on the Skagit River (Shannon & Wilson, 2010).

The hydraulic characteristics of the river that are relevant to a risk analysis of a levee are the geometry of the channel and flow velocity. Channel bathymetry and levee profile form the riverside slope that is to be analyzed. Flow velocity and channel impingements are determinants of scour potential. For the risk analyses presented in this report, channel shapes were developed from bathymetry measurements (USACE, 2010) and estimated flow velocities (NHC, 2010a).

For purposes of a levee risk analysis, the hydrologic characteristics of the river are only indirectly relevant. A risk analysis is based on conditional probabilities of failure where the assumed condition is one or more river stages. The analysis does not depend on knowledge of the likelihood of occurrence of a given river stage; however, the assumed maximum river stages must be consistent with the river's hydrologic regime and hydraulic characteristics. For the risk analyses presented in this report, the maximum river stage was assumed to be equal to the elevation of the levee crest based on historical evidence of overtopping (Shannon & Wilson, 2010).

The levee structural characteristics that are relevant to a risk analysis include the geometry of the levee, including height, slope angles, crest width, set back and armoring (e.g., riprap); and the location and type of non-levee structural features such as bridge piers or utility under-crossings. Levee geometry for the risk analyses presented in this report were derived from a review of design and construction drawings and LIDAR data. The only non-levee structural features on the lower Skagit River (River Mile [RM] 7.1 to RM 17.4) appear to be roadway and railway bridges.

The levee and foundation geotechnical characteristics that are important to a risk analysis include the soil physical strength and hydraulic conductivity properties; subsurface layering; and other natural forces, such as earthquakes, that could affect a levee's reliability. The geotechnical characteristics for the risk analyses presented in this report were developed from site-specific subsurface exploration data and field and laboratory test results (Shannon & Wilson, 2010) and previous subsurface exploration data (USACE, various; Golder, 2009).

4.1 Quantifiable Failure Modes

Quantifiable failure modes are those for which conventional, quantitative methods are available to estimate conditional probabilities of failure. The quantifiable failure modes identified for the Skagit River levees include:

- Underseepage
- Riverside and landside static slope failure
- Riverside and landside seismic slope failure
- Riverside slope failure due to rapid drawdown

4.1.1 Underseepage

Underseepage can occur in situations in which one or more highly permeable soil layers extend beneath a levee from the river to the landside of the levee. A high river stage of sufficient duration creates a hydraulic gradient from the river to the landside surface that may result in landside heave and sand boils. Underseepage that occurs in these conditions, even in the absence of levee slope failure, is considered to be a levee failure.

4.1.2 Riverside and Landside Static Slope Failure

Static slope failure occurs when the steepness of a slope and the mass of the soil on the slope exceed the strength of the slope soils. The static stability of a levee is also affected by the

river stage. Of special concern with respect to levees are riverside or landside static slope failures that intersect the levee crest.

4.1.3 Riverside and Landside Seismic Slope Failure

Seismic slope failure is similar to static slope failure but with an added, potentially destabilizing, seismic inertial force. Seismic slope failure is distinguished from seismic liquefaction failure (discussed in Section 4.2) in that seismic slope failure can occur without the reduction of soil shear strength that typically occurs during seismic liquefaction failure.

Seismic slope failure occurs when the steepness of a slope and the mass of the soil on the slope plus the seismic inertial force exceed the strength of the slope soils. The seismic stability of a levee is also affected by the river stage. Although the likelihood of an earthquake occurring simultaneously with high river stage may be low, a seismic slope failure that occurs without sufficient time to repair the failure before the next high river stage would have the same effect as a simultaneous earthquake and high river stage event.

4.1.4 Riverside Slope Failure Due to Rapid Drawdown

Slope failure due to rapid drawdown can occur when the river stage drops quickly from a relatively static level. During the higher static river stage, the groundwater level in the levee embankment would be at or near the river stage level. When the river stage drops more quickly than the groundwater level in the embankment can respond, a potentially unstable condition is created by the groundwater level in the embankment remaining above the river level.

4.2 Other Failure Modes

Other failure modes are those that require qualitative or semi-quantitative approaches to estimating a conditional probability of failure. The other failure modes identified for the Skagit River levees include:

- Liquefaction
- Throughseepage
- Scour
- Sequential failure

4.2.1 Liquefaction

Liquefaction or partial liquefaction is the loss of shear strength in a saturated, granular soil during an earthquake. Liquefaction in the soils in or beneath the Skagit River levees could

result in lateral displacement and settlement of the levee or levee foundation soils. Although the likelihood of an earthquake occurring simultaneously with high river stage may be low, liquefaction may occur at any river stage. The damage may occur without sufficient time to repair before the next high river stage or the damages may not be clearly evident but still sufficiently severe to reduce the design level of protection provided by the levee.

4.2.2 Throughseepage

Throughseepage is flow of water through a levee embankment, as distinguished from underseepage, which is flow of water in a permeable soil layer beneath a levee embankment. Throughseepage occurs when a high river stage of sufficient duration creates a hydraulic gradient from the river to the landside surface of the levee. Water flowing through a levee tends to follow the most permeable path which may be more permeable levee materials, animal burrows, vegetation roots, or other openings in the embankment. Throughseepage can result in piping or excess porewater pressures that can lead to levee slope failure.

4.2.3 Scour

Scour is the removal of river bank or levee embankment soils by the water in the river. The potential for scour depends on the river bank or levee soil type, the velocity and impingement angle of the flowing water, and the roughness of the river bank or levee surface. River bank and levee scour tends to remove soil from the toe or slope of an embankment, resulting in a less stable embankment or embankment failure.

4.2.4 Sequential Failure

Sequential failure of a levee is a series of smaller embankment failures that can lead to failure of the entire embankment. In a sequential failure, each successive failure leaves behind an unstable slope that also fails. Sequential failures can be initiated by changes in the embankment's structure or properties due to factors such as scour, earthquake, or seepage.

4.3 Other Failure Mode Factors and Uncertainties

Other factors that have been identified for the Skagit River levees that can affect the estimates of the conditional probability of failure are listed below. Some of these factors are partially considered in the quantitative methods used to estimate conditional probabilities of failure and others must be considered qualitatively. In general, qualitative methods will have more uncertainty than quantitative methods.

- River stage duration
- Length effect
- Channel configuration
- Non-levee structural features
- Surface elevation uncertainty
- Soil unit contact uncertainty
- Method uncertainty

4.3.1 River Stage Duration

The duration of a river stage can affect quantitative estimates of the conditional probability of levee failure due to underseepage, static slope failure, and rapid drawdown. In general, quantitative estimates of the conditional probability of levee failure are made under the assumption that the river stage duration is sufficient to develop a static hydraulic gradient from the river to the levee's landside surface elevation. A river stage of shorter duration may result in a less severe hydraulic gradient and a lower estimate of the conditional probability of levee failure. The river stage duration can also affect qualitative estimates of scour probability and likelihood of sequential failure. The effect of river stage duration on the conditional probabilities of levee failure can be evaluated by considering transient hydraulic conditions in the quantitative analyses.

4.3.2 Length Effect

Length effect refers to the applicable length of an estimate of conditional probability of levee failure and the impact of levee length on the estimated probability. The estimated conditional probabilities of failure are generally based on a representative section of levee within a longer stretch of levee with similar characteristics and similar response to changes in river stage. If the entire levee reach is viewed as a system, with each section being an independent link, then the conditional probability of failure of the entire length will be greater than the conditional probability of failure of an individual section. The effect of levee length on the conditional probabilities of levee failure is generally evaluated using a semi-quantitative approach.

4.3.3 Channel Configuration

Conventional, quantitative methods of estimating conditional probability of levee failure are generally based on the assumption that the river channel at the analysis location is straight and flow is parallel to the levee. The effect that river bends, bars, and other natural features have on flow direction and velocity can alter the estimated conditional probabilities of levee failure.

The effect of channel configuration on the conditional probabilities of levee failure is generally evaluated using semi-quantitative or qualitative approaches.

4.3.4 Non-Levee Structures

The presence of non-levee structural features such as bridge piers can also alter the estimated conditional probability of levee failure. Conventional, quantitative methods of estimating conditional probability of levee failure do not consider the presence of non-levee structural features. The effect of non-levee structural features on the conditional probabilities of levee failure is generally evaluated qualitatively.

4.3.5 Surface Elevation Uncertainty

River channel, levee, and ground surface profiles for the eight Skagit River levee analysis locations were developed from bathymetry measurements, design and construction drawings, and LIDAR and survey data. The data used to develop the profiles have inherent uncertainties that can alter the estimated conditional probabilities of levee failure. River channel, levee, and ground surface profiles between the analysis sections will likely vary as well, which adds another source of uncertainty to the application of the probabilities of levee failure to those locations. The effect of surface profile elevation uncertainty on the conditional probabilities of levee failure can be evaluated by varying the elevations in the quantitative analyses.

4.3.6 Subsurface Contact Elevation Uncertainty

The contact elevations between the levee embankment and foundation soil layers at the eight analysis sections were developed primarily from data from the two geotechnical borings at each location. For the quantitative analyses, the contact elevations were extended horizontally beyond the boring locations. The data used to develop the contact elevations have inherent uncertainties and the contact elevations between the analysis sections will likely vary as well. These uncertainties can alter the estimated conditional probabilities of levee failure and will add another source of uncertainty to the application of the probabilities to locations between the analysis sections. The effect of contact elevation uncertainty on the conditional probabilities of levee failure can be evaluated by varying the elevations in the quantitative analyses.

4.3.7 Method Uncertainty

The analytical methods used to estimate conditional probabilities of levee failure are approximations of the behavior of a levee embankment and foundation at a given river stage. These approximations introduce uncertainty into the estimated conditional probabilities of levee

failure. The relative degree of uncertainty introduced by the choice of analytical methods can be evaluated by calculating conditional probabilities of levee failure by alternative methods.

5.0 ANALYTICAL METHODS

The quantitative and semi-quantitative analytical methods used to calculate factors of safety (FSs) and conditional probabilities of failure are described in the following sections.

5.1 Underseepage

An FS for underseepage is defined as:

$$F_S = i_c / i$$

where:

i = calculated steady state gradient at the landside toe of the levee

i_c = critical gradient

and the critical gradient is defined as:

$$i_c = \gamma'_s / \gamma_w$$

where:

γ'_s = buoyant unit weight of the overbank soil at the landside toe of the levee

γ_w = unit weight of water

A seepage gradient greater than or equal to the critical gradient is assumed to cause sand boils or heave (flotation) of the relatively less permeable soils overlying the more pervious underseepage soil layer.

Underseepage gradients (i) were calculated for each river stage at each analysis location using SEEP/W 2007 (Geo-Slope, 2010a). Underseepage gradients at selected river stages and locations were also calculated using a method described in EM 1110-2-1913, Appendix B (USACE 2000).

5.1.1 Underseepage Calculation with SEEP/W

SEEP/W is a software program that uses a two-dimensional finite element method to simulate fluid flow and pressure distribution in saturated and unsaturated porous materials such as soil and rock. Fluid flow and pressure distribution can be analyzed under steady state or transient conditions.

The software is based on the assumption that fluid flow through the material obeys Darcy's Law:

$$q = -K i$$

where:

q = specific discharge

K = hydraulic conductivity

i = hydraulic gradient

The governing equation used in SEEP/W is:

$$K_x \frac{\partial^2 H}{\partial x^2} + K_y \frac{\partial^2 H}{\partial y^2} + Q = 0$$

where:

K_x = hydraulic conductivity in the x-direction

K_y = hydraulic conductivity in the y-direction

H = total head

Q = applied boundary flux

The general steps required for an analysis with SEEP/W are to:

- (1) Define the cross section geometry (river bathymetry, levee and ground surface profile, and subsurface soil layer contacts)
- (2) Create the finite element mesh
- (3) Define the material properties for each soil type
- (4) Define the flow boundary conditions

The geometry of a model is defined in its entirety before creating a mesh. A mesh is generally created using an automatic mesh generator and modified by the user as required.

Boundary conditions are specified according to the physical conditions and the type of analysis (steady state or transient). For steady state analysis, boundary conditions are either fixed-head (or pressure) or fixed-flux values. For transient analysis, one or more boundary conditions can be set as a function of time or a response to flow exiting or entering the flow regime. An example is presented in Appendix B showing the geometry, mesh, and boundary conditions for a seepage analysis at analysis section DD17-1L.

The material properties used in the SEEP/W analyses are presented in Section 6.0.

5.1.2 Underseepage Calculation by USACE EM 1110-2-1913 Method

The underseepage calculation method presented in EM 1110-2-1913 is a closed-form solution based on the following simplifying assumptions:

- (1) Seepage may enter the pervious layer at any point on the riverside of the levee
- (2) Flow through the soil layer(s) overlying the seepage layer is vertical
- (3) Flow through the pervious layer is horizontal
- (4) Flow is laminar
- (5) The levee and soil layer(s) overlying the seepage layer are impervious.

This method provided a basic check of the SEEP/W analysis and provided data for an evaluation of the uncertainty associated with the selected approach to calculating underseepage gradients.

The geometric relationships of river, levee, and foundation soils and material properties used in the closed-form calculation of underseepage were the same as used in the equivalent SEEP/W analyses. The material properties used for seepage analysis are presented in Section 6.0.

5.2 Slope Stability

Slope stability analyses were completed to provide input to calculations of probability of failure (see Section 5.3). These analyses were completed in general accordance with EM 1110-2-1913 (USACE, 2000) and EM 1110-2-1902 (USACE, 2003). Analyses were performed using the software program SLOPE/W 2007 (GEO-SLOPE, 2010b).

5.2.1 Slope Stability Calculation with SLOPE/W

SLOPE/W is a software program that uses two-dimensional limit equilibrium methods to calculate an FS against sliding along a continuous surface in a soil or rock mass. The calculation

can include the effects of groundwater and seismic forces on the FS. FSs were computed for circular failure surfaces using the Morgenstern-Price limit equilibrium procedure which satisfies moment and force equilibrium equations and accounts for interslice shear and normal forces.

The general steps required for the calculation of an FS with SLOPE /W are to:

- (1) Define the cross section geometry (ground surface profile and subsurface soil layer contacts)
- (2) Define the material failure criteria and properties for each soil type
- (3) Define the groundwater regime, if any
- (4) Define the analysis type and limits

The geometry developed for the SEEP/W models and porewater pressure distributions calculated by SEEP/W were used for the Skagit River levee stability analyses. The Mohr-Coulomb failure criterion was used for all of the soil types in the SLOPE/W analyses. Material properties for the soils are presented and discussed in Section 6.0.

In conventional deterministic slope stability analysis it is typical practice to seek a slip surface with the lowest FS, as the consequences of slope failure can only be evaluated after the location of the potential failure surface is determined. For levee risk analysis, however, the primary interest is in slope failures that compromise the ability of the levee to provide the intended protection.

To consider slip surfaces that would compromise the levee, we restricted the slip surface search to entry points at the levee crest and exit points near the levee toe (riverside or landside toe). The SLOPE/W slip surface search routine was used to find the critical slip surface within the entry and exit point limits. Slip surfaces with lower FSs may exist in the riverside or landside levee embankment, but embankment failure along those surfaces would not immediately compromise the levee and we assume that surface failures would be repaired during routine maintenance.

An example is presented in Appendix B showing the geometry and search criteria for a slope stability calculation at analysis section DD17-1L.

5.2.2 Static Factor of Safety (FS) Calculations

Static FSs were calculated for riverside and landside slip surfaces for four to six river stages at each of the eight analysis locations.

An FS was first calculated for the most-likely-value case at each location (riverside and landside). The most-likely-value case was based on our determination of the most likely values of the SLOPE/W input parameters of unit weight, friction angle, and steady state porewater pressure for the two soil types used in the analysis. An additional 12 FSs were then calculated by sequentially varying one of the input parameters by plus or minus one standard deviation from its most likely value. Most-likely-value and plus or minus one standard deviation values of steady state porewater pressures were imported from the SEEP/W analysis completed for each river stage at each location.

Slip surface entry and exit point limits were defined separately for the riverside and landside static FS calculations, but the same limits were used for the most-likely-value case and the associated parameter variation cases. The critical slip surface for each case was allowed to vary subject to the entry and exit point limits.

5.2.3 Seismic Factor of Safety (FS) Calculations

Seismic FSs were calculated for riverside and landside slip surfaces in the same manner as static FSs except with an additional horizontal force applied to represent the inertial forces of an earthquake. The horizontal force is determined from the mass of the soil slices used in the calculation of FS and from an input acceleration coefficient. The acceleration coefficient is generally assumed to be one-half of the peak ground acceleration of the earthquake (Hynes-Griffin, Franklin, 1984). The force is applied to the slices in the downslope direction. Seismic FSs were calculated assuming that there is no reduction of shear strength of the levee and foundation soils as would be considered in an analysis of liquefaction.

A peak ground acceleration coefficient of 0.2 was used to calculate seismic FSs for the Skagit River levees. The acceleration coefficient was obtained from our analysis of the Operating Basis Earthquake with a return period of 144 years and a 50 percent probability of exceedance for a service life of 100 years (Shannon & Wilson, 2010).

Seismic FSs were first calculated for the most-likely-value case at each location (riverside and landside). An additional twelve FSs were then calculated by sequentially varying one of the input parameters by plus or minus one standard deviation from its most likely value. Most-likely-value and plus or minus one standard deviation values of steady state porewater pressures were imported from the SEEP/W analysis completed for each river stage at each location.

5.2.4 Rapid Drawdown Factor of Safety (FS) Calculations

Static FSs for the riverside levee under rapid drawdown conditions were calculated at each analysis location for a scenario of a 13-foot drop in river stage over a period of 3.6 days beginning from a river stage equal to the levee crest.

The rapid drawdown scenario was developed from a discharge rating curve for the U.S. Geological Survey river gage at Mt. Vernon (USGS, 2010) and hydrographs from the gage at Mt. Vernon from November-December 1995, October 2003, and November 2006 (USGS, 1995, 2003, 2006). In each of these periods there was a high discharge event that peaked at or near 140,000 cubic feet per second (cfs). The discharge following these events fell at an average rate of about 25,000 cfs per day over a period of three to five days. The rating curve and hydrographs are shown in Figure 14. These data were used to calculate the average drop in river stage and average drawdown period used as the rapid drawdown scenario. Because this scenario was developed from three apparently extreme cases and the calculated probability of failure was near zero, no further rapid drawdown scenarios were considered.

An FS for rapid drawdown was first calculated for the most-likely-value case at each location (riverside only). An additional twelve FSs were then calculated by sequentially varying one of the input parameters by plus or minus one standard deviation from its most likely value. Most-likely-value and plus or minus one standard deviation values of transient porewater pressures were imported from the SEEP/W analysis completed for the rapid drawdown scenario at each location.

The slip surface entry and exit point limits that were established for the calculation of static FSs were used in the rapid drawdown factor of safety calculations.

5.3 Probability of Failure by Taylor Series Method

River stage versus probability-of-failure functions were developed for each of the analysis sections using the Taylor Series method (USACE, 1992, 1995; Wolff and Wang, 1992; Shannon & Wilson and Wolff, 1994; Wolff and others, 1996). The Taylor Series method is one of several first-order second-moment methods used to assess reliability. These methods are based on the concept that uncertainty in a given performance function (e.g., an FS) can be estimated from the uncertainty in the model parameters (e.g., soil strength parameters or porewater pressures).

The general procedure of the Taylor Series method used to determine a probability of failure is as follows: the expected value of the performance function is obtained by first evaluating the performance function using the expected values of the input parameters, x_N , to obtain the most likely value of the function, F_{MLV} . The standard deviation of the performance function, σ_F , is then determined using the following equation:

$$\sigma_F = \sqrt{\left(\frac{\partial F_1}{\partial x_1}\right)^2 \sigma_{x,1}^2 + \left(\frac{\partial F_2}{\partial x_2}\right)^2 \sigma_{x,2}^2 + \dots + \left(\frac{\partial F_N}{\partial x_N}\right)^2 \sigma_{x,N}^2}$$

where $\partial F_N / \partial x_N$ is the partial derivative of the performance function with respect to the N th input parameter and $\sigma_{x,N}$ is the standard deviation of the N th input parameter. The partial derivatives are approximated numerically over an interval centered on the expected value. To evaluate partial derivatives we used an interval of plus one to minus one standard deviation as is generally recommended in the literature (USACE, 1999; Shannon & Wilson and Wolff, 1994).

When an interval of plus one to minus one standard deviation is used to evaluate the partial derivatives, the equation for σ_F simplifies to:

$$\sigma_F = \sqrt{\left(\frac{\Delta F_1}{2}\right)^2 + \left(\frac{\Delta F_2}{2}\right)^2 + \dots + \left(\frac{\Delta F_N}{2}\right)^2}$$

where $\Delta F_N = (F_N^+ - F_N^-)$. F_N^+ is the performance function evaluated with the N th parameter value increased one standard deviation from its expected value, and F_N^- is the performance function evaluated with the N th parameter variable decreased one standard deviation from its expected value. In calculating F_N^+ and F_N^- for the N th parameter, the values of the other parameters are kept at their expected values. Once the expected value and standard deviation of the performance function are determined, the coefficient of variability of the performance function V_F and log normal reliability index, β_{LN} , are calculated as follows:

$$V_F = \frac{\sigma_N}{F_{MLV}} \quad \text{and} \quad \beta_{LN} = \frac{\ln\left(\frac{F_{MLV}}{\sqrt{V_F}}\right)}{\ln(V_F)}$$

Because the reliability index is assumed to be from a standard normal distribution (mean = 0.0 and standard deviation = 1.0), the probability of non-failure, P_{nf} , can be determined from a table of the standard normal distribution and the probability of failure from $P_f = 1 - P_{nf}$.

5.4 Probability of Failure by Monte Carlo Method

The Monte Carlo method is an alternative to the Taylor Series method for estimating the conditional probability of slope failure. Whereas the Taylor Series method assumes that the FS for a slope is log-normally distributed, the Monte Carlo method uses the individual distributions of the input parameters (e.g., unit weight, friction angle) to determine the distribution of the FS. The distribution is determined by making repeated calculations of FS, each time randomly drawing a complete set of input parameters from the individual parameter distributions.

The Monte Carlo method implemented in SLOPE/W was used to estimate a conditional probability of failure for three Skagit River levee cases. The results of these three cases were used to evaluate the uncertainty in the estimated conditional probability of failure associated with the choice of analytical method (Taylor Series or Monte Carlo).

Generally, the steps required for the calculation of a probability of failure with SLOPE/W are similar to the steps for a deterministic analysis as described in Section 5.2 with the exception that the material parameters are defined as probability distributions rather than discrete values.

The input parameters that can be entered as distributions are the unit weight of the soils and failure criteria parameters. For the Mohr-Coulomb failure criterion used in these analyses, the input parameters that can be entered as distributions are cohesion and friction angle. The input parameter distributions for the three Skagit River levee cases were assumed to be Gaussian (normal) distributions with mean values equal to the most likely values used in the Taylor Series analyses and standard deviation values equal to the standard deviation values used in the Taylor Series analyses. Material property distributions for the soils are presented and discussed in Section 6.0.

To calculate a probability of failure, the SLOPE/W software first determines a critical slip surface for the given slope geometry and analysis type using the average values of the input parameters. The FS for the critical slip surface is then repeatedly calculated with each calculation using a different set of input parameters drawn from the specified distributions. The software counts the frequency of occurrence of FSs in intervals to develop a histogram representing the probability distribution of the FS for the critical slip surface. We specified that 2,000 calculations of FS be performed to develop the histogram for each of the three Skagit River levee cases.

5.5 Scour Probability

The contribution of scour to the conditional probability of failure of the Skagit River levees was evaluated semi-quantitatively using a probabilistic procedure described in ETL 1110-2-556 (USACE, 1999). This procedure, which is based on the evaluation of a performance function similar to a Taylor Series analysis (see Section 5.3), was used to develop graphs of the conditional probability of scour versus water height. The quantitative estimate of probability of scour was used to make a qualitative estimate based on engineering judgment of the impact of scour on the combined conditional probability of levee failure.

The probabilistic procedure described in ETL 1110-2-556 is based on a comparison between a probable flow velocity, V , and a critical flow velocity, V_{crit} , that would result in scour. Flow velocity is assumed to be a function of water depth, the slope of the energy line (approximately equal to the average slope of the river channel), and surface roughness. Water depth is assumed to range from the deepest point in the river to levee crest and the mean and coefficient of variation of slope and roughness can be estimated or measured.

The procedure uses an adaptation of Manning's formula to calculate flow velocity, V , as:

$$V = \frac{1.486y^{2/3}S^{1/2}}{n}$$

where:

- y = depth of flow
- S = slope of the energy line
- n = Manning's roughness coefficient

The coefficient of variation of velocity, CV_{vel} , is calculated from the coefficients of variation of S and n as:

$$CV_{vel} = \sqrt{CV_n^2 + \frac{CV_S^2}{4}}$$

where:

- CV_n = coefficient of variation of Manning's n
- CV_S = coefficient of variation of the slope of the energy line

If the performance function, V_{crit}/V is assumed to be log-normally distributed, a reliability index, β , can be calculated as:

$$\beta = \frac{\ln\left(\frac{V_{crit}}{V}\right)}{\sqrt{CV_{vel\ crit}^2 + CV_{vel}^2}}$$

where:

V_{crit}	= critical velocity
V	= velocity
$CV_{vel\ crit}$	= coefficient of variation of the critical velocity
CV_{vel}	= coefficient of variation of probable velocity

Scour probability, i.e., the probability of the limit state of the performance function, V_{crit}/V being equal to or greater than 1, can then be determined by comparing β to tables of the cumulative normal distribution.

5.6 Liquefaction

Liquefaction or partial liquefaction is the loss of shear strength in a saturated, granular soil during an earthquake and can result in settlement or lateral spreading of a levee and its foundation. The settlement or lateral spreading can result in a lowering of the levee crest or an embankment failure which would compromise the ability of the levee to provide its intended protection. Although the likelihood of an earthquake occurring simultaneously with a high river stage may be low, liquefaction may occur at any river stage.

Previous analysis of liquefaction potential at the analyses locations (Shannon & Wilson, 2010) concluded that the FS against liquefaction during an Operating Basis Earthquake (OBE) was less than one for thicknesses of up to 15 feet. The OBE has a return period of 144 years and a 50 percent probability of exceedance for a service life of 100 years.

The semi-quantitative approach taken to evaluate the contribution of liquefaction to the conditional probability of failure of the Skagit River levees was to estimate a threshold return period that could cause liquefaction. Earthquakes with a return period less or equal to than the threshold would be assumed to have an FS against liquefaction greater than one. Earthquakes with a return period greater than the threshold would be assumed to have an FS against

liquefaction less than one at some locations and depths, potentially resulting in liquefaction or partial liquefaction.

The underlying assumption of this approach is that earthquakes that are less severe than OBE, but with a greater frequency of occurrence, can cause liquefaction damage to the levees. The quantitative estimate of liquefaction potential was used to make a qualitative estimate based on engineering judgment of the impact of liquefaction on the combined conditional probability of levee failure.

The threshold return period was determined using the same analytical procedures that were used in the previous analysis of the OBE. The input peak soft rock acceleration and amplification factor were incrementally reduced to find a level at which the FS against liquefaction was greater than one for every analysis location and depth.

5.7 Throughseepage

Numerical and closed form calculations of seepage failure in the Skagit River levees are controlled by underseepage through a highly permeable soil layer beneath the levees and overbank soils. Consequently, the contribution of throughseepage to the combined conditional probability of failure of the Skagit River levees was evaluated qualitatively.

Erosion or piping resulting from high hydraulic gradients may occur within a levee embankment due to the presence of preferential seepage paths resulting from conditions such as cracking, animal burrowing, or decay of roots. High exit gradients on the landside face of the levee or internal erosion from high hydraulic gradients within the levee may initiate piping beginning at the landside face of the levee where the hydraulic gradient is highest and progressing into the levee.

The Skagit River levees are vegetated in many areas and may be susceptible to animal burrowing, but, in our opinion, the likelihood of through-going seepage paths being initiated in these levees by decaying roots or animal burrows is small in comparison to the other factors affecting levee reliability and, therefore, a more detailed quantitative analysis was not justified. However, the potential for throughseepage failure was incorporated in our estimate of probability of failure based on engineering judgment.

5.8 Sequential Failure

The contribution of sequential failure to the combined conditional probability of failure of the Skagit River levees was evaluated semi-quantitatively by calculating the conditional probability of a scenario of sequential riverside slope failures. The quantitative estimate of probability of sequential failure was used to make a qualitative estimate based on engineering judgment of the impact of sequential failure on the combined conditional probability of levee failure.

A sequential failure scenario was developed by assuming that during a rapid drawdown condition an initial riverside slope failure would occur that did not intersect the levee crest and that the soil mass that failed would be washed away by the river, leaving a new slope. The new slope in turn would fail and the second soil mass would be washed away. The third and final slope failure was assumed to intersect the levee crest, thereby compromising the ability of the levee to provide the intended protection.

The conditional probability of the first failure can be expressed as $Pf_1 = P(f_1 | H)$. The notation is read as '*the probability of the first failure given a river stage of H*'. The conditional probability of the second failure is $Pf_2 = P(f_2 | H \cup f_1)$ which is read as '*the probability of the second failure given a river stage of H and the first failure has occurred*'. Finally, the conditional probability of the third failure is $Pf_3 = P(f_3 | H \cup f_1 \cup f_2)$ which is read as '*the probability of the third failure given a river stage of H and the first failure has occurred and the second failure has occurred.*' If $P(H)$ is the probability of river stage H occurring, the probability of all four events (river stage H and three failures) is $P(H \cup f_1 \cup f_2 \cup f_3) = P(H) \cdot Pf_1 \cdot Pf_2 \cdot Pf_3$.

Rearranging terms yields $P(H \cup f_1 \cup f_2 \cup f_3) / P(H) = Pf_1 \cdot Pf_2 \cdot Pf_3$, which is a conditional probability of failure that is directly comparable to the other conditional probabilities of failure calculated for the levee risk analysis.

Conditional probabilities of failure Pf_1 , Pf_2 , and Pf_3 were calculated for the sequential failure scenario using SLOPE/W by specifying a fixed river stage and performing the following steps:

- (1) Calculate the first probability of failure, Pf_1
- (2) Remove the soil mass above the first failure surface from the model
- (3) Calculate the second probability of failure, Pf_2
- (4) Remove the soil mass above the second failure surface from the model
- (5) Calculate the third probability of failure, Pf_3

6.0 INPUT VARIABLES AND DISTRIBUTIONS

The limit state calculations performed for the Skagit River levee risk analysis included seepage, slope stability, scour probability, and liquefaction potential. The input variables for these calculations and our estimates of most likely values and variability of the parameters are presented in the following sections.

6.1 Seepage Variables

The input parameters used for the Skagit River levee seepage analyses performed with the SEEP/W software were horizontal hydraulic conductivity, a ratio of vertical to horizontal hydraulic conductivity, and a volumetric water content function.

Horizontal hydraulic conductivity is a measure of the rate of the horizontal flow of water through a volume of soil. Field test data (Shannon & Wilson, 2010) were used to develop horizontal hydraulic conductivity values for the pervious layer underlying the levee and overbank soils. The average (most likely value) and standard deviation of the horizontal hydraulic conductivity of the pervious soil layer and the values used in our analyses are presented in Table 3. The average and standard deviation were calculated from the results of eight slug tests performed in the landside borings at the Skagit River analysis locations (Shannon & Wilson, 2010). A range of horizontal hydraulic conductivity values for the levee, overbank, and sub-layer soils was estimated from typical values reported in the literature for these material types (Freeze and Cherry, 1979). The most likely value and estimated standard deviation of horizontal hydraulic conductivity for these soils are also shown in Table 3.

As a further check of these estimates, hydraulic conductivity was also calculated from grain size distribution tests performed on 87 sand and gravel samples from the pervious layer (Shannon & Wilson, 2010). Hydraulic conductivity was computed using the relationship (USAWES, 1956):

$$k = C \cdot (D_{10})^2$$

where:

k = hydraulic conductivity, centimeters per second (cm/sec)

C = a constant

D_{10} = effective grain size, millimeter (mm)

The effective grain size is the particle diameter at which 10 percent of the soil particles are smaller. The constant was assumed to be equal to one. The average hydraulic conductivity

calculated from this relationship was 3.6×10^{-2} cm/sec with a coefficient of variation of about 85 percent as compared to an average of 1.2×10^{-2} cm/sec and a coefficient of variation of about 33 percent for the slug tests. The relatively close agreement between the two methods of estimating hydraulic conductivity provided further evidence that the most likely value estimated from the slug tests was reasonable.

The ratio of vertical to horizontal hydraulic conductivity describes the relative rate of vertical to horizontal flow of water through a soil mass. The range of this ratio was estimated from typical values reported in the literature for these material types (Freeze and Cherry, 1979). A fixed value for the ratio was used in the seepage FS calculations, but a sensitivity analysis was performed to estimate the impact of the ratio on the combined conditional probability of failure of the levees. The most likely values and estimated standard deviations of hydraulic conductivity ratio are shown in Table 4.

A volumetric water content function describes the volume of water stored in voids in a soil mass as function of porewater pressure. In the absence of site-specific test data for this function we used a function for sand provided in the SEEP/W documentation (Geo-Slope, 2010a). We performed a parametric analysis of the function control values and concluded that the model results were not sensitive to the assumed range of function control values for the soils present in the Skagit River levees and foundations.

Boundary conditions are a critical component of a numerical seepage analysis. In the SEEP/W analyses, the riverside boundary of the model was defined as a constant head boundary equal to the head of the river stage being analyzed. The landside face of the levee from crest to toe was defined as a seepage face and the horizontal ground surface from the toe and beyond was defined as a zero pressure boundary. Vertical boundaries of the model were defined as constant head boundaries equal to the head at those locations. An example is presented in Appendix B showing the geometry, mesh, and boundary conditions for a seepage analysis at analysis section DD17-1L.

Secondary seepage calculations performed by the method presented in EM 1110-2-1913 (USACE, 2000) require input variables of horizontal hydraulic conductivity and hydraulic conductivity ratio. The values of these variables that were used in the SEEP/W analyses were also used in the secondary seepage calculations.

6.2 Slope Stability Variables

The calculation of FS for a Mohr-Coulomb soil by limit equilibrium methods using the SLOPE/W software requires input of soil total unit weight, cohesion, and friction angle.

Total unit weight describes the weight of a unit volume of soil and water. Total unit weight values for the overbanks and sub-layer soils were determined from the results of laboratory tests performed on those soils. Total unit weight values for the pervious layer were estimated from typical values reported in the literature (Peck and others, 1974). The most likely values and standard deviations for total unit weight are shown in Table 5. The coefficient of variability (CoV) for the unit weight of the soils is generally less than CoV's reported in the literature. In our opinion, the lower CoV values used in our analyses are reasonable based on laboratory measurements and our experience with similar soils and geologic environments.

Cohesion and friction angle describe the shear strength of a Mohr-Coulomb soil. Because the Skagit River levee and foundation soils are predominantly granular soils, cohesion was assumed to be zero and an effective stress analysis was performed. Friction angle values for the levee, overbank, and sub-layer soils were estimated from the results of laboratory tests performed on those soils. Friction angle values for the pervious layer were estimated from SPT blow counts and typical values reported in the literature (Peck and others, 1974). The most likely values and standard deviations for friction angle are shown in Table 6.

6.3 Scour Probability Variables

Scour probability is the likelihood that scour would occur under a given set of river and levee conditions. The input variables required for the scour probability calculations include the critical velocity, slope of the energy line, Manning's roughness coefficient, and water depth.

The critical velocity is the water velocity at which scour is initiated. Scour probability versus water depth was determined for critical velocities of 3, 4, and 5 feet per second (fps). This range of critical velocities was selected from a table of allowable velocities for soil type ranging from silty sands to coarse gravels (Simons and Senturk, 1992). Although modeling performed by NHC indicated that cross sectional channel velocities range from 5.5 to 9.5 fps (NHC, 2010a), the water velocity at the river bank and levee slope will generally be less than the average channel velocity, hence the choice of critical velocities.

The slope of the energy line was approximated by the river bed slope. River bed slope values were obtained from a numerical model developed by NHC (NHC, 2010b) and from LIDAR data.

Manning's roughness coefficient values were estimated from typical values reported in the literature (ASCE, 1996). The most likely values and standard deviations for the scour probability input variables are shown in Table 7.

6.4 Liquefaction Potential Variables

An analysis of the liquefaction potential for a given earthquake depends on Standard Penetration Test (SPT) blow counts, percent fines of a granular soil, and the Atterberg Limits plasticity index for a cohesive soil. SPT blow counts are a measure of the relative density/consistency of a soil. Percent fines is the percentage by weight of particles in a soil mass that are less than 0.075 mm in diameter. Atterberg Limits plasticity index is a range of water contents where a soil is considered plastic.

The SPT blow counts, percent fines, and Atterberg Limits plasticity indices used in our analysis of liquefaction potential were obtained from our previous geotechnical report (Shannon & Wilson, 2010). Rather than determining the distribution (most likely value and standard deviation) of the input variables, the measured values of the input variables were used to estimate liquefaction threshold return periods at each analysis location and a most likely value and standard deviation of threshold return period was calculated from those results.

7.0 RELIABILITY ANALYSIS RESULTS

7.1 Quantifiable Failure Modes

7.1.1 Overview

The results of the quantitatively analyzed failure modes are discussed in the following sections. We prepared depth-normalized graphs of the results for several of the failure modes (see Figures 15 to 18). The depth-normalization consisted of converting river stage (elevation) to water-depth-below-crest. Although the analyses were performed using river stage and elevation data and the fragility curves are presented in terms of river stage (elevation), we found it useful to compare the conditional probabilities of individual failure modes in terms of water-depth-below-crest rather than river stage. This comparison aided us in identifying the similarities and differences among the eight analysis locations.

7.1.2 Underseepage

The conditional probability of underseepage failure (exit gradient greater than critical gradient) is plotted versus depth below levee crest in Figure 15 for direct comparison of the

analysis sections. This figure shows that our analysis of underseepage with SEEP/W indicates that the conditional probability of underseepage failure is near zero at all analysis sections except DD1-1R, DD1-2R, and DD17-1L. In general, the analysis sections exhibiting underseepage failure have the greatest difference in elevation between the levee crest and landside toe (seepage exit point) which would lead to larger water head differences between the river and seepage exit point.

As shown in Figure 15, a non-zero conditional probability of underseepage failure begins at river stages 4 to 6 feet below the levee crest for analysis sections DD1-1R and DD17-1L. However, at analysis section DD1-2R, the non-zero conditional probability of underseepage failure begins at a river stage 10 feet below the levee crest. The earlier onset of seepage failure at DD1-2R is attributed to the relatively shorter seepage path to the levee landside toe (approximately 120 feet) and the relatively thinner (approximately 8-foot-thick) overbank layer at the landside toe at this location as compared to conditions at sections DD1-1R and DD17-1L. The other five analysis locations have relatively longer seepage paths and relatively thicker landside toe overbank layers.

A sensitivity analysis for the hydraulic conductivity ratio was performed using section DD1-1R at a river stage of 35.2 feet. The sensitivity analysis was run using minimum and maximum credible values for the ratio. The conditional probability of underseepage failure for the most likely value was 0.29, and for the minimum and maximum credible values, 0.22 and 0.38, respectively. The effect on the fragility curve for this range of conditional probabilities ($\sim\pm 25\%$) would be similar at this analysis section as underseepage appears to be the controlling mode of failure at this location. The fragility curve at analysis section DD17-1L also appears to be controlled by underseepage and may have similar sensitivity to the assumed hydraulic conductivity ratio. The uncertainty of the hydraulic conductivity ratio was considered in the development of the fragility curves for DD1-1R and DD17-1L. The other six analysis sections have near-zero conditional probabilities of underseepage failure and, hence, would be less affected by the uncertainty of the hydraulic conductivity ratio.

7.1.3 Landside Static Failure

The conditional probability of landside static slope failure is plotted versus depth below levee crest in Figure 16. In general, landside static slope stability appears to be controlled by the high porewater pressures that develop in the levee during steady state seepage.

A non-zero conditional probability of landside static failure was found at every analysis section except DD1-1R and DD22-1R. The absence of landside static slope failures at DD1-1R is attributed to the thickness of the landside toe overbank layer (more than 20 feet thick, limiting seepage) and the buttressing effect of soil at the landside toe that has the shape of a seepage control blanket. The absence of landside static slope failures at DD22-1R is attributed to the thickness of the landside toe overbank layer (about 18 feet thick) and to the relatively smaller difference in elevation between the levee crest and landside toe.

For analysis sections DD3-1L, DD17-1L, DD17-2L, DD17-3L, and DD22-2L, the onset of landside static failures was at river stages from 2 to 5 feet below the levee crest. At DD1-2R, the onset of landside static failures began at a river stage 10 feet below the levee crest. The earlier onset at DD3-1L, DD17-1L, DD17-2L, DD17-3L, and DD22-2L is attributed to the relatively thinner (approximately 8- to 10-foot-thick) overbank layer at the landside toe at this location which resulted in earlier development of high porewater pressure in the levee and earlier onset of underseepage.

7.1.4 Riverside Static Failure

The calculated conditional probabilities of riverside static failure were essentially equal to zero for all analysis sections and river stages analyzed. Although pore water pressures in the riverside levee slopes would be as great, or greater, than in the landside levee slopes, the buttressing effect of the water helps to maintain an FS greater than one in the riverside slopes.

7.1.5 Landside Seismic Failure

The calculated conditional probabilities of landside seismic failure are presented in Figure 17. The calculated probabilities in this figure have two conditions, a given river stage has occurred and an OBE has occurred.

The doubly conditioned probability is expressed as $P(f_S | H \cup E)$ which is read as ‘*the probability of the failure given a river stage of H and an earthquake E*’. By definition, the conditional probability is $P(f_S | H \cup E) = P(f_S \cup H \cup E) / P(H \cup E)$, which is read as ‘*the probability of failure and river stage and earthquake divided by the probability of the river stage and the earthquake.*’

Assuming that the river stage and earthquake are independent events, $P(H \cup E)$ can be rewritten as $P(H) \cdot P(E)$. Rearranging terms yields $P(f_S | H \cup E) \cdot P(E) = P(f_S \cup H \cup E) / P(H)$, which is a conditional probability of failure that is directly comparable to the other conditional

probabilities of failure calculated for the levee risk analysis. Thus, in calculating the combined probability of failure for a given river stage, the probabilities shown in Figure 17 were multiplied by probability of an OBE to obtain a probability that is only conditioned on the given river stage.

The variability in the conditional probabilities of landside seismic failure curves appear to be partially due to the variable conditions described for landside static failures and partially due to the steepness and angle of the landside slopes.

7.1.6 Riverside Seismic Failure

The calculated conditional probabilities of riverside seismic failure are presented in Figure 18. The calculated probabilities in this figure have two conditions, a given river stage has occurred and an OBE has occurred. In calculating the combined conditional probability of failure for a given river stage, the probabilities shown in Figure 18 were multiplied by probability of an OBE to obtain a probability that is only conditioned on the given river stage as described in Section 7.1.5.

The conditional probabilities of riverside seismic failure appear to fall in three groups. One group, represented by analysis sections DD1-1R and DD17-1L, has a conditional probability of failure at or near one at all river stages. The second group, represented by analysis sections DD1-2R, DD17-2L, DD17-3L and DD22-2L, has a conditional probability of failure of about 0.5 beginning at the lowest river stage analyzed, rising to a probability of near one at a river stage 7 to 8 feet below the levee crest. The third group, represented by analysis sections DD3-1L and DD22-1R, has a non-zero conditional probability of failure beginning at river stages 18 to 19 feet below the levee crest, rising to a probability of near 0.5 at a river stage 6 feet below the levee crest. The increase and subsequent decrease in the conditional probabilities of riverside seismic failure versus river stage is attributed to the buttressing effect of the water relative to the seismic inertial force. At lower river stages the buttressing effect has a smaller influence on riverside slope stability; but, at some critical river stage, the buttressing effect becomes sufficient to reduce the probability of seismic failure.

7.2 Other Failure Modes

7.2.1 Liquefaction Potential

The results of our analysis of liquefaction potential are presented in Table 8. This table shows the estimated threshold return period for the initiation of liquefaction for each of the Skagit River analysis sections.

The results of the liquefaction potential analysis indicate that the range of threshold return periods is 20 to 219 years with an average of about 61 years and a standard deviation of about 48 years. These results imply that partial liquefaction and subsequent lateral spreading or settlement could occur more frequently than would be indicated by consideration of an OBE alone.

Based on our analysis and engineering judgment, we have incorporated the effects of liquefaction potential in our estimate of the combined conditional probability of failure, recognizing that liquefaction may not result in complete failure of a levee.

7.2.2 Throughseepage

Erosion or piping resulting from high hydraulic gradients may occur within a levee embankment due to the presence of preferential seepage paths resulting from conditions such as cracking, animal burrowing, or decay of roots. High exit gradients on the landside face of the levee or internal erosion from high hydraulic gradients within the levee may initiate piping beginning at the landside face of the levee where the hydraulic gradient is highest and progressing into the levee.

The Skagit River levees are vegetated in many areas and may be susceptible to animal burrowing, but, in our opinion, the likelihood of through-going seepage paths being initiated in these levees by decaying roots or animal burrows is small in comparison to the other factors affecting levee reliability. However, the potential for throughseepage failure was incorporated in our estimate of probability of failure based on engineering judgment.

7.2.3 Scour Probability

The results of the scour probability analysis are presented in Figures 19 and 20 for the Skagit River main stem and the North and South Forks, respectively. The graphs show the probability of scour for a range of water depths, channel slopes (slope of the energy line), roughness coefficients, and critical velocities. The upper graph in each of these figures shows the relative effect of varying the channel slope for a fixed roughness coefficient and critical velocity, the middle graphs show the relative effect of varying the roughness coefficient for a fixed channel slope and critical velocity, and the lower graphs show the relative effect of varying the critical velocity for a fixed channel slope and roughness coefficient.

For the range of channel slopes, roughness coefficients, and critical velocities considered, the graphs in Figures 19 and 20 indicate that the greatest uncertainty in the estimates of scour

probability is due to uncertainty in the critical velocity. The critical velocity primarily depends on the levee or river bank soil type and vegetation cover, and may have considerable variation along the length of the study area. Although there are no revetments at the eight analysis sections, the protection provided by a revetment would reduce the likelihood of scour.

At seven of the eight analysis sections, the riverside slope of the levee extends 50 to 70 feet toward the river at a relatively flat angle. Consequently, the water depths near the levee crest would generally be less than about 15 feet even at the highest river stage. The scouring probability would be lower in these areas than in the river channel where the water may be 30 to 50 feet deep when the river stage is at the levee crest. At analysis section DD22-1R, however, the riverside slope of the levee extends toward the river at a steeper angle, which would result in greater water depths nearer to the levee crest and, hence, a greater probability of scour near the levee crest. In general, the presence of a sloping bench between the levee and the river would appear to limit the probability of scour that could directly impact the levee crest. Based on our analysis of scour probability and engineering judgment, we have incorporated the effects of scour in our estimate of the combined conditional probability of failure.

7.2.4 Sequential Failure

The results of an analysis of a sequential failure scenario are presented in Figure 21. The conditional probabilities of failure for the sequence of three scour and sliding events given an initial river stage of 31.4 feet drawn down to 18.4 feet are 0.59, 0.71, and 0.88. The combined conditional probability of failure for the three events is then $0.59 \cdot 0.71 \cdot 0.88 = 0.37$. The combined conditional probability of failure should also be reduced by an estimate of the probability of scour occurring at each step in this scenario. The river level at the conclusion of the sequential failure is below the landside surface elevation and, therefore no immediate flooding would occur in this scenario. However, in the absence of repairs, the levee would no longer provide its intended level of protection and would be susceptible to further damage and potential flooding during subsequent high river stages.

Based on our analysis and interpretation of this scenario, it appears that the probability of sequential failure would only be significant in the case of a repeated high river stage and significant scour of the riverside slopes. Sequential failure can also occur on the landside slope of a levee due to seepage related erosion and piping. However, a landside sequential failure may be a relatively slower process and may require more than one high river stage to progress to failure. The possibility of riverside and landside sequential failures has been incorporated in our estimate of probability of failure based on engineering judgment.

7.2.5 Contribution to Combined Conditional Probability of Failure

Based on our semi-quantitative analysis of other failure modes and engineering judgment, we have concluded that these modes could make a substantial contribution to the combined probability of levee failure. We estimate that the conditional probability of failure for the aggregate of these modes could range from 0.1 to 0.3 for a river stage 1 foot below the levee crest. This range of probabilities was estimated by considering the number of potential failure modes evaluated by semi-quantitative and qualitative methods. Each potential failure mode will have a small conditional probability of failure that, in the aggregate, can constitute a probability of this magnitude. Considering the number of potential failure modes that cannot be analyzed by quantitative methods and the uncertainty in the input parameters and methods used for the quantitative methods, it is our opinion that this range of judgmental conditional probabilities is realistic.

We have included a conditional probability of failure of 0.2 for a river stage 1 foot below the levee crest in the fragility curves presented in Section 9. These failure modes may also contribute a small amount to the conditional probability of failure at lower river stages, but, in our opinion, the uncertainty of estimating small probabilities does not justify their inclusion in the combined conditional probability of failure.

7.3 Other Failure Mode Factors

7.3.1 River Stage Duration

The stability analyses used to develop the combined conditional probabilities of levee failure presented in this report were based on a conservative assumption of steady state seepage conditions. Our transient seepage analysis for each of the eight locations indicate that steady stage seepage conditions are reached in three to four days for a constant river stage.

To evaluate the effect of the steady state assumption, we considered a scenario at analysis section DD17-1L in which the river stage was assumed to rise and fall approximately 20 feet to elevation 38.9 feet within two days. In this scenario, the seepage conditions are transient and porewater pressures do not fully develop in the levee embankment. The most likely static FS for the landside slope under steady state conditions was 1.2 with conditional probability of failure of 0.013. For the transient condition, the most likely static FS was 2.5 with a conditional probability of failure of 0.0.

The effects of transient seepage conditions scenarios were not included in our estimates of the combined conditional probabilities of levee failure. However, in our opinion, the probability of levee failure would generally be lower for short duration river stages.

7.3.2 Length Effect

The length effect was evaluated by estimating a conditional probability of failure of a chain of levee sections using a generic conditional probability of failure curve for a single section in the system as the basis of the calculation. The system of levee sections and the single section are assumed to have similar conditions and response to changes in river stage. In this evaluation, we assumed that the conditional probability of failure of the single section applied to a length of levee L , and estimated a conditional probability of failure for $2L$, $3L$, $5L$, $10L$, and $20L$ levee lengths. The length L could be taken as a breach width or other characteristic length of levee. The system of levees was assumed to have failed if any one of the levee sections failed.

The results of the length effect evaluation are shown in Figure 22. The figure shows that as the length of the system of levees increase, the conditional probability of failure of the chain increases at every river stage.

The length effect was not included in our estimates of the combined conditional probabilities of levee failure because there is insufficient information to define a characteristic length L . However, in our opinion, the length effect should be included in subsequent risk-based analyses that address the levees as a system.

7.3.3 Channel Configuration

The effect of river bends, bars, and other natural features on flow direction and velocity were not explicitly considered in the development of the combined conditional probabilities of levee failure presented in this report. These effects should be considered if the probabilities are used in the analysis of levees in other than straight reaches.

7.3.4 Non-Levee Structures

The effect of river non-levee structures on flow direction and velocity were not explicitly considered in the development of the combined conditional probabilities of levee failure presented in this report. These effects should be considered if the probabilities are used in the analysis of levees at or adjacent to non-levee structures.

7.3.5 Measurement Uncertainty

The influence of measurement uncertainty on the combined conditional probabilities of levee failure was evaluated by varying the elevation of the top of the pervious layer at one analysis section. Based on measurement uncertainties and uncertainties introduced by projecting this elevation over the width of our model, we assumed that the elevation of the top of the pervious layer could vary by plus or minus 1 foot and calculated a conditional probability of underseepage failure and landside static slope failure. These calculations were performed using the DD17-1L model and a river stage of 38.9 feet.

The conditional probability of underseepage failure at this analysis section and river stage using the most likely value of the elevation of the top of the pervious layer was 0.28. If the elevation of this subsurface contact is lowered one foot, the conditional probability of underseepage failure becomes 0.0012. If the elevation is raised 1 foot, the conditional probability of underseepage failure is 0.9998. The top stratum in this case is the only barrier to underseepage, hence the conditional probability of underseepage failure is sensitive to changes in the thickness of the top stratum. For this analysis section, the most likely value of the top stratum thickness is approximately 8 feet at the landside toe of the levee.

The conditional probability of landside static slope failure at this analysis section and river stage using the most likely value of the elevation of the top of the pervious layer was 0.013. If the elevation of this subsurface contact is lowered 1 foot, the conditional probability of static slope failure becomes 0.004. If the elevation is raised 1 foot, the conditional probability of static slope failure is 0.295.

These analyses demonstrate the potential effect of measurement uncertainty on the conditional probabilities of failure. The assumption of a uniform, 1-foot error in one direction or the other may be conservative because measurement errors are more likely to be randomly distributed. However, the uncertainty introduced by projecting measured elevations over the width of the model may not be conservative. The consequence of this uncertainty would be reflected in uncertainty in the fragility curves presented in Section 9.

7.3.6 Method Uncertainty

The influence of method uncertainty on the combined conditional probabilities of levee failure was evaluated by comparing probabilities calculated by the Taylor Series and Monte Carlo methods.

Monte Carlo analyses were performed for three static stability cases: DD17-1L landside at river stage 42.0 feet, DD1-2R landside at river stage 15.0 feet, and DD17-1L riverside at river stage 19.4 feet. These cases were selected because they represented a wide range of most likely FSs and probabilities of failure. The input parameter distributions were assumed to be Gaussian (normal) distributions with mean values equal to the most likely values used in the Taylor Series analyses and standard deviation values equal to the standard deviation values used in the Taylor Series analyses.

The results of the Taylor Series and Monte Carlo analyses for these three cases are summarized in Table 9. Because of the similarity of input parameters and assumed distributions for both methods, the probabilities of failure are also similar. The differences between the two methods are seen in the range of FSs considered and in the reliability index. If non-normal distributions were assumed for the input parameters for the Monte Carlo method, the differences in probabilities could be greater.

Based on the results of our limited Monte Carlo analysis, we did not include a component of method uncertainty in the calculation of conditional probabilities of levee failure presented in this report.

8.0 $P_f = 0$ CALIBRATION

8.1 Estimate of $P_f = 0$ River Stage

Based on the historical evidence of seepage failure generally being the first sign of levee failure on the Skagit River, we assumed that the $P_f = 0$ river stage could be estimated using Casagrande's seepage theory to determine the river stage that would result in the onset of seepage at the landside levee toe. Based on the average dimensions of the Skagit River levees, we estimated that seepage would begin at a river stage 5 to 6 feet below the levee crest. We selected a river stage of 5 feet below the levee crest as the $P_f = 0$ river stage for seepage-only failure for all analysis sections. Also, based on the historical records, it appears that flooding due to other failure modes such as embankment failure are relatively rare events. This would imply that a $P_f = 0$ river stage with respect to other failure modes is closer to the levee crest. We estimated that the $P_f = 0$ river stage for failure modes other than seepage is approximately 2 feet below the levee crest for all analysis sections.

8.2 $P_f = 0$ Calibration

Our analyses indicated that for analysis sections controlled by underseepage failure, the onset of a non-zero conditional probability would begin at river stages from 3 to 10 feet below the levee crest with an average of about 6 feet. For analysis sections controlled by other modes of failure, the onset of a non-zero conditional probability would begin at river stages from 2 to 4 feet below the levee crest with an average of about 3 feet. Based on these results, additional calibration of the levee reliability was, in our opinion, not required.

9.0 FRAGILITY CURVES

9.1 Fragility Curve Development

The fragility curves (conditional probability of levee failure versus river stage) for the eight Skagit River levee analysis sections are presented in Figure 23 through 30. The fragility curves for each failure mode and the combined fragility curve for all failure modes are shown in these figures. The combined conditional probability of failure was calculated under an assumption of independence of the individual failure modes. Based on this assumption, we calculated the combined conditional probability of failure (P_{fc}) as

$$P_{fc} = 1 - (1 - P_{f1}) * (1 - P_{f2}) * \dots * (1 - P_{fn})$$

where P_{f1} through P_{fn} are the conditional probabilities of failure for failure modes 1 through n.

The fragility curves for each analysis section are accompanied by a table showing the conditional probability of failure and the conditional probability of non-failure for each failure mode and river stage. In the accompanying tables, the probabilities with a yellow background were calculated by one of the quantitative methods described in this report. The probabilities with a blue background were calculated by linear interpolation between adjoining river stages where it was determined to be necessary and reasonable. The probabilities with a gray background were determined using engineering judgment and were included in the calculation of the combined conditional probability of failure.

9.2 Fragility Curve Discussion

The following is a summary of the primary conclusions we have drawn from the fragility curves. For this summary, we have selected a conditional probability of failure of $P_f \leq 0.01$ as being approximately equivalent to the $P_f = 0$ discussed in Section 8. Almost all river stages have some

conditional probability of failure greater than 0, but the probabilities at lower river stages are often very small.

Section DD1-1R:

Fragility controlled by underseepage, estimated $P_f \geq 0.01$ river stage is about 36 feet (approximately 3 feet below crest).

Section DD1-2R:

Fragility controlled by underseepage, estimated $P_f \geq 0.01$ river stage is about 15 feet (approximately 10 feet below crest).

Section DD3-1L:

Fragility controlled by landside static stability, estimated $P_f \geq 0.01$ river stage is about 27 feet (approximately 2 feet below crest).

Section DD17-1L:

Fragility controlled by underseepage, estimated $P_f \geq 0.01$ river stage is about 39 feet (approximately 4 feet below crest).

Section DD17-2L:

Fragility controlled by landside static stability, estimated $P_f \geq 0.01$ river stage is about 37 feet (approximately 2 feet below crest).

Section DD17-3L:

Fragility controlled by landside static stability, estimated $P_f \geq 0.01$ river stage is about 34 feet (approximately 5 feet below crest).

Section DD22-1R:

Fragility controlled by judgment, estimated $P_f \geq 0.01$ river stage is about 22 feet (approximately 2 feet below crest).

Section DD22-2L:

Fragility controlled by landside static stability, estimated $P_f \geq 0.01$ river stage is about 17 feet (approximately 4 feet below crest).

As noted in Section 4, a fragility curve analysis treats each failure mode equally and may lead to a conservative estimate of the likelihood of levee failure.

10.0 LIMITATIONS

This report was prepared for the exclusive use of the USACE. Within the limitations of the scope, schedule and budget, the recommendations presented in this report were prepared in accordance with generally accepted professional geotechnical engineering principles and practice in this area at the time this report was prepared. The analyses and conclusions contained in this report are based on site conditions as they existed at the time of our studies. Rivers are complex and dynamic systems that are continually changing due to erosion, deposition, and other natural processes and human activities. The uncertainty associated with complex and dynamic systems must be recognized in these types of studies. We make no other warranty, either express or implied.

Shannon & Wilson, Inc. has prepared Appendix C, "Important Information About Your Geotechnical/Environmental Report," to assist you and others in understanding the use and limitations of our report.

SHANNON & WILSON, INC.



Brian S. Reznick, P.E.
Principal Engineer

A handwritten signature in black ink, appearing to read "Hollie L. Ellis".

Hollie L. Ellis
Senior Vice President

HLE:BSR:GRF/hle

11.0 REFERENCES

- American Society of Civil Engineers, 1996, Hydrology handbook, ASCE manuals and reports on engineering practice no. 28, 2nd ed., ASCE, New York.
- Freeze, R.A., and Cherry, J.A., 1979, Groundwater: Prentice-Hall, Inc., New Jersey.
- Geo-Slope International Ltd., 2010a, Seepage modeling with SEEP/W 2007 version.
- Geo-Slope International Ltd., 2010b, Stability modeling with SLOPE/W 2007 version.
- Golder Associates, 2009, PIE/Burlington geotechnical and levee report.
- Hynes-Griffin, M.E., and Franklin, A.G., 1984, Rationalizing the seismic coefficient method: U.S. Army Engineer Waterways Experiment Station, Vicksburg, Mississippi.
- Northwest Hydraulic Consultants (NHC), 2010a, Cross-sectional averaged channel velocities: e-mail communication from Malcolm Leytham, May 3.
- Northwest Hydraulic Consultants (NHC), 2010b, Representative average channel slopes by reach: e-mail communication from Malcolm Leytham, May 14.
- Peck, R. B.; Hanson, W.E.; and Thornburn, T.H., 1974, Foundation engineering, 2nd edition, John Wiley & Sons, New York.
- Puget Sound LIDAR Consortium, <http://pugetsoundlidar.ess.washington.edu>, 2003 survey.
- Shannon & Wilson, Inc., 2009, General investigation report, Skagit River basin levees, Skagit County, Washington: Report prepared by Shannon & Wilson, Inc., Seattle, Wash., 21-1-21199-001, for U.S. Army Corps of Engineers, 1 v., August 26.
- Shannon & Wilson, Inc., 2010, Skagit River levee general investigation, geotechnical and hydrogeologic data and liquefaction evaluation report, Skagit County, Washington: Report prepared by Shannon & Wilson, Inc., Seattle, Wash., 21-1-21199-002, for U.S. Army Corps of Engineers, 1 v., March 17.
- Shannon & Wilson, Inc., and Wolff, T.F., 1994, Probability models for geotechnical aspects of navigations structures, report to the St. Louis District, U.S. Army Corps of Engineers.
- Simons, D.B., and Senturk, F., 1992, Sediment transport technology: water and sediment dynamics, Water Resources Publication, Littleton, CO.
- U.S. Army Corps of Engineers, 1992, Engineer Technical Letter 1110-2-532, Reliability assessment of navigation structures: U.S. Army Corps of Engineers.

- U.S. Army Corps of Engineers, 1995, Engineer Technical Letter 1110-2-547, Introduction to probability and reliability methods for use in geotechnical engineering.
- U.S. Army Corps of Engineers, 1999, Engineer Technical Letter 1110-2-556, Risk-based analysis in geotechnical engineering for support of planning studies.
- U.S. Army Corps of Engineers, 2000, Engineer Manual 1110-2-1913, Design and construction of levees.
- U.S. Army Corps of Engineers, 2003, Engineer Manual 1110-2-1902, Slope stability.
- U.S. Army Corps of Engineers, 2010, Additional LIDAR and survey data, via e-mail from T. Goss (USACE).
- U.S. Army Engineer Waterways Experiment Station, 1956, Technical Memorandum 3-424, Investigation of underseepage and its control, lower Mississippi River levees, 2 volumes.
- U.S. Geological Survey, 1995, Instantaneous Data Archive, USGS 12200500 Skagit River near Mt. Vernon 11/15/1995 to 12/11/1995, WA, <http://ida.water.usgs.gov>.
- U.S. Geological Survey, 2003, Instantaneous Data Archive, USGS 12200500 Skagit River near Mt. Vernon 10/15/2003 to 11/01/2003, WA, <http://ida.water.usgs.gov>.
- U.S. Geological Survey, 2006, Instantaneous Data Archive, USGS 12200500 Skagit River near Mt. Vernon 11/01/2006 to 11/21/2006, WA, <http://ida.water.usgs.gov>.
- U.S. Geological Survey, 2010, National Water Information System, USGS 12200500 Skagit River near Mt. Vernon, WA, retrieved 01/05/2010, <http://water.usgs.gov/data.html>.
- Wolff, T. F., and Wang, W., 1992, Engineering reliability of navigation structures, research report, Michigan State University: Report to the U.S. Army Corps of Engineers Waterways Experiment Station, Vicksburg, MS.
- Wolff, T.F.; Demsky, E.C.; Schauer, J.; and Perry, E., 1996, Reliability assessment of dam and levee embankments: Proceedings of Uncertainty '96, ASCE Geotechnical Special Publication No. 58, C.D. Shackelford, P.P. Nelson, and M.J.S. Roth, eds., p. 636-650.

TABLE 1
ANALYSIS SECTION NAMES AND RIVER MILE

Analysis Section Name	River	Bank	River Mile
DD17-1L	Skagit River	Left	17.40
DD17-2L	Skagit River	Left	16.10
DD1-1R	Skagit River	Right	14.00
DD17-3L	Skagit River	Left	13.55
DD3-1L	South Fork	Left	8.75
DD1-2R	North Fork	Right	8.60
DD22-1R	South Fork	Right	8.30
DD22-2L	North Fork	Left	7.10

TABLE 2
ANALYSIS SECTION BATHYMETRIC MEASUREMENTS

Analysis Section	River	River Mile	Bathymetry Location	Rationale
DD17-1L	Skagit River	17.40	17.51	Bathymetric measurement at River Mile (RM) 17.51 shows right bank bar similar to bar visible in air photo at analysis location; next nearest bathymetric measurement does not show a bar
DD17-2L	Skagit River	16.10	16.25	Bathymetric measurement at RM 16.25 in straight reach of river similar to analysis location; next nearest bathymetric measurement in start of bend
DD1-1R	Skagit River	14.00	14.00	Bathymetric measurement location matches analysis location
DD17-3L	Skagit River	13.55	13.88	Bathymetric measurement at RM 13.88 in straight reach of river; next nearest bathymetric measurement in start of bend with bar
DD3-1L	South Fork	8.75	8.75	Bathymetric measurement location matches analysis location
DD1-2R	North Fork	8.60	8.85	Bathymetric measurement at RM 8.85 in straight reach of river similar to analysis location; next nearest bathymetric measurement in start of bend with bar
DD22-1R	South Fork	8.30	7.80	Nearest bathymetric measurement used; next nearest bathymetric measurement may in an area with a bar
DD22-2L	North Fork	7.10	7.20	No other adjacent bathymetric measurement

TABLE 3
SUMMARY OF INPUT VARIABLES, HYDRAULIC CONDUCTIVITY

Pervious Layer Soils				
Data Source: Slug Tests				
	Measured Values		Analysis Values	
	ft/sec	cm/sec	ft/sec	cm/sec
Average	3.8E-04	1.2E-02	4.0E-04	1.2E-02
St Deviation	1.3E-04	3.9E-03	1.3E-04	4.0E-03
CoV	33%	33%	33%	33%
Avg + 1 St Dev	5.1E-04	1.5E-02	5.3E-04	1.6E-02
Avg - 1 St Dev	2.5E-04	7.7E-03	2.7E-04	8.2E-03
Levee, Overbank, and Sublayer Soils				
Data Source: Credible Values				
	Estimated Values		Analysis Values	
	ft/sec	cm/sec	ft/sec	cm/sec
MLV ⁽¹⁾	1.8E-06	5.5E-05	1.8E-06	5.5E-05
MaxCV ⁽²⁾	3.3E-06	1.0E-04		
MinCV ⁽³⁾	3.3E-07	1.0E-05		
3 Sigma St Dev	4.9E-07	1.5E-05	5.0E-07	1.5E-05
3 Sigma CoV ⁽⁴⁾	27%	27%	28%	28%
Avg + 1 St Dev	2.3E-06	7.0E-05	2.3E-06	7.0E-05
Avg - 1 St Dev	1.3E-06	4.0E-05	1.3E-06	4.0E-05

Notes:

- (1) MLV = most likely value
(2) MaxCV = maximum credible value
(3) MinCV = minimum credible value
(4) CoV = coefficient of variability
ft/sec = feet per second

TABLE 4
SUMMARY OF INPUT VARIABLES, HYDRAULIC CONDUCTIVITY RATIO^(*)

Pervious Layer Soils		
Data Source: Credible Values		
	Estimated Values	Analysis Values
MLV ⁽¹⁾	0.35	0.35
MaxCV ⁽²⁾	0.50	
MinCV ⁽³⁾	0.20	
3 Sigma St Dev	0.05	
3 Sigma CoV ⁽⁴⁾	14%	
Avg + 1 St Dev	0.40	
Avg - 1 St Dev	0.30	
Levee, Overbank, and Sublayer Soils		
Data Source: Credible Values		
	Estimated Values	Analysis Values
MLV ⁽¹⁾	0.20	0.20
MaxCV ⁽²⁾	0.30	
MinCV ⁽³⁾	0.10	
3 Sigma St Dev	0.03	
3 Sigma CoV ⁽⁴⁾	17%	
Avg + 1 St Dev	0.23	
Avg - 1 St Dev	0.17	

Notes:

(*) Hydraulic conductivity ratio = ratio of vertical hydraulic conductivity to horizontal hydraulic conductivity

(1) MLV = most likely value

(2) MaxCV = maximum credible value

(3) MinCV = minimum credible value

(4) CoV = coefficient of variability

TABLE 5
SUMMARY OF INPUT VARIABLES, TOTAL UNIT WEIGHT

Pervious Layer		
Data Source: Credible Values		
	Effective Stress	
	Estimated Values	Analysis Values
	lb/cu. ft.	
MLV ⁽¹⁾	120	120
MaxCV ⁽²⁾	125	
MinCV ⁽³⁾	115	
3 Sigma St Dev	2	2
3 Sigma CoV ⁽⁴⁾	1%	2%
Avg + 1 St Dev	122	122
Avg - 1 St Dev	118	118
Levee, Overbank, and Sublayer Soils		
Data Source: Laboratory Tests		
	Measured Values	Analysis Values
	lb/cu. ft.	
Consol-1 ⁽⁵⁾	107	
Consol-2	108	
CU-1 ⁽⁶⁾	108	
CU-2	107	
CU-3	110	
Average	108	108
CoV	1%	1%
Std Deviation	1	1
Avg + 1 St Dev	109	109
Avg - 1 St Dev	107	107
3 Sigma CoV	1%	
3 Sigma Std Dev	1	
Avg + 1 St Dev	108	
Avg - 1 St Dev	107	

Notes:

- (1) MLV = most likely value
(2) MaxCV = maximum credible value
(3) MinCV = minimum credible value
(4) CoV = coefficient of variability
(5) Consol-X = consolidation test
(6) CU-X = consolidated, undrained triaxial test
lb/cu. ft. = pounds per cubic foot

TABLE 6
SUMMARY OF INPUT VARIABLES, FRICTION ANGLE

Pervious Layer		
Data Source: Credible Values		
	Effective Stress	
	Estimated Values	Analysis Values
	degrees	
MLV ⁽¹⁾	31	31
MaxCV ⁽²⁾	38	
MinCV ⁽³⁾	24	
3 Sigma St Dev	2	2
3 Sigma CoV ⁽⁴⁾	8%	6%
Avg + 1 St Dev	33	33
Avg - 1 St Dev	29	29
Levee, Overbank, and Sublayer Soils		
Data Source: Laboratory Tests		
	Effective Stress	
	Measured Values	Analysis Values
	Degrees	
CU-1 ⁽⁵⁾	33	
CU-2	36	
CU-3	37	
Average	35	35
CoV	6%	6%
Std Deviation	2	2
Avg + 1 St Dev	37	37
Avg - 1 St Dev	33	33
3 Sigma CoV	2%	6%
3 Sigma Std Dev	1	2
Avg + 1 St Dev	36	37
Avg - 1 St Dev	35	33

Notes:

- (1) MLV = most likely value
(2) MaxCV = maximum credible value
(3) MinCV = minimum credible value
(4) CoV = coefficient of variability
(5) CU-X = consolidated, undrained triaxial test
% = percent

TABLE 7
SUMMARY OF INPUT VARIABLES, SCOUR PROBABILITY

Slope of the Energy Line		
Data Source: Credible Values		
	Skagit River	North and South Fork
MLV ⁽¹⁾	0.00048	0.00040
CoV ⁽²⁾	15%	15%
Std Dev	0.00007	0.00006
Avg + 1 St Dev	0.00055	0.00046
Avg - 1 St Dev	0.00041	0.00034
Manning's Roughness Coefficient		
Data Source: Credible Values		
	Estimated Values	
MLV ⁽¹⁾	0.035	
CoV ⁽²⁾	10%	
Std Dev	0.004	
Avg + 1 St Dev	0.039	
Avg - 1 St Dev	0.032	
Critical Velocity		
Data Source: Credible Values		
	Estimated Values feet/second	
MLV ⁽¹⁾	4	
CoV ⁽²⁾	20%	
Std Dev	0.8	
Avg + 1 St Dev	5	
Avg - 1 St Dev	3	

Notes:

(1) MLV = Most likely value

(2) CoV = Coefficient of variability

% = percent

**TABLE 8
LIQUEFACTION THRESHOLD RETURN PERIOD**

Analysis Section	Threshold Soil Acceleration (g)	Threshold Recurrence Interval (years)
DD1-1 Landward	0.14	43
DD1-1 Levee	0.18	100
DD1-2 Landward	0.11	23
DD1-2 Levee	0.16	69
DD3-1 Landward	0.13	38
DD3-1 Levee	0.23	219
DD17-1 Landward	0.14	47
DD17-1 Levee	0.16	63
DD17-2 Landward	0.18	100
DD17-2 Levee	0.16	63
DD17-3 Landward	0.14	42
DD17-3 Levee	0.13	38
DD22-1 Landward	0.13	38
DD22-1 Levee	0.12	32
DD22-2 Landward	0.10	20
DD22-2 Levee	0.14	47
	Average	61
	Std Dev	48
	Coefficient of Variation	78%

Note:
% = percent

**TABLE 9
SUMMARY OF MONTE CARLO ANALYSES**

Location	DD17-1L		DD1-2R		DD17-1L	
Slope	Landside		Landside		Riverside	
River Stage (feet)	43.2		15.8		20.6	
Analysis	MC ⁽¹⁾	TS ⁽²⁾	MC	TS	MC	TS
Mean FS ⁽³⁾	0.60	0.56	1.07	1.07	1.58	1.58
Standard Deviation of FS	0.06	0.13	0.08	0.08	0.10	0.10
Minimum ⁽⁴⁾ FS	0.38	0.53	0.73	0.99	1.22	1.48
Maximum ⁽⁴⁾ FS	0.79	0.63	1.51	1.15	1.88	1.67
Reliability Index	-6.39	-4.52	0.90	0.84	5.90	7.21
Conditional Probability of Failure	1.00	1.00	0.21	0.20	0.00	0.00

Notes:

(1) MC = Monte Carlo method

(2) TS = Taylor Series method

(3) FS = factor of safety

(4) Minimum and maximum factor safety considered in the analysis.



LEGEND

- Approximate Boring Location
- Profiles
- City Boundary
- Levees

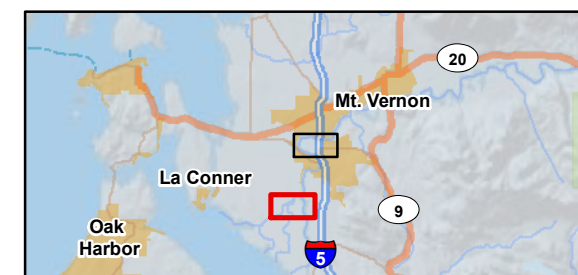
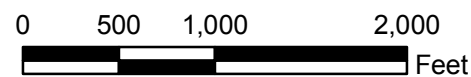
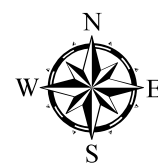

Skagit River Levee General Investigation
 Levee Risk and Reliability Analysis
 Skagit County, Washington

ANALYSIS CROSS SECTION LOCATIONS

January 2011



21-1-21199-003

SHANNON & WILSON, INC.
 GEOTECHNICAL AND ENVIRONMENTAL CONSULTANTS

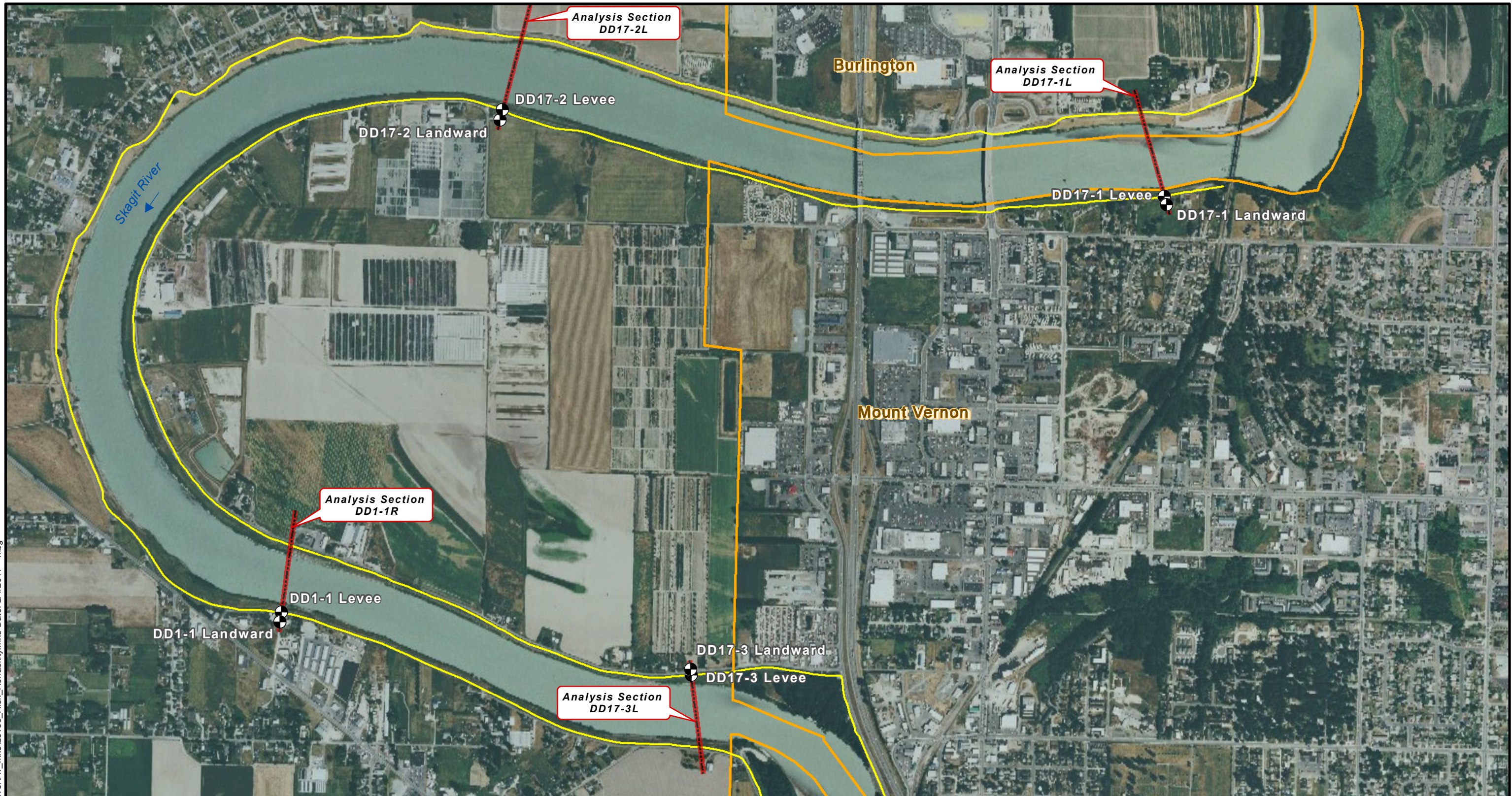
FIG. 1
 Sheet 1 of 2

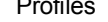

LEGEND

- Approximate Boring Location 
- Profiles 
- City Boundary 
- Levees 

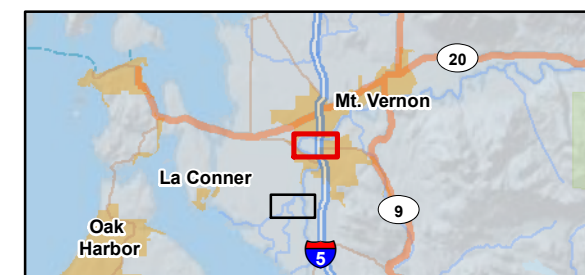
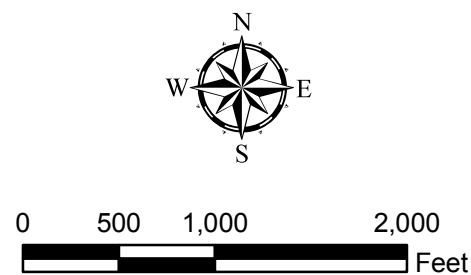

Skagit River Levee General Investigation
Levee Risk and Reliability Analysis
Skagit County, Washington

ANALYSIS CROSS SECTION LOCATIONS

January 2011 21-1-21199-003

SHANNON & WILSON, INC.
GEOTECHNICAL AND ENVIRONMENTAL CONSULTANTS

FIG. 1
Sheet 2 of 2

Complete Model

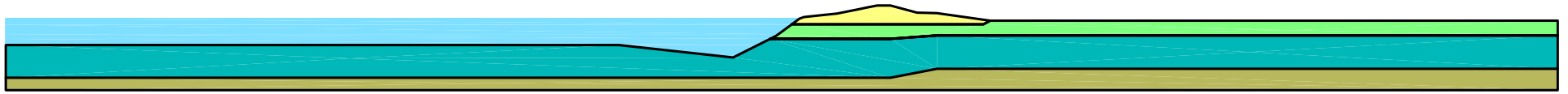

Detail

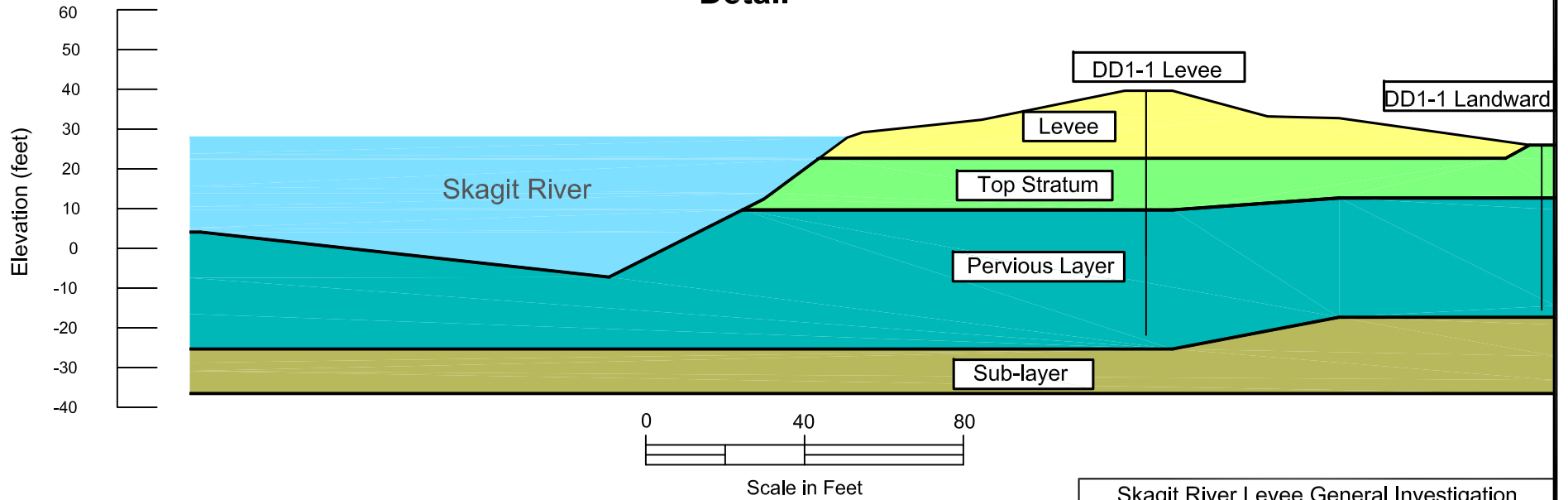

Skagit River Levee General Investigation
 Levee Risk and Reliability Analysis
 Skagit County, Washington

DD1-1R CROSS SECTION

January 2011

21-1-21199-003

SHANNON & WILSON, INC.
 Geotechnical and Environmental Consultants

FIG. 2

FIG. 2

Complete Model

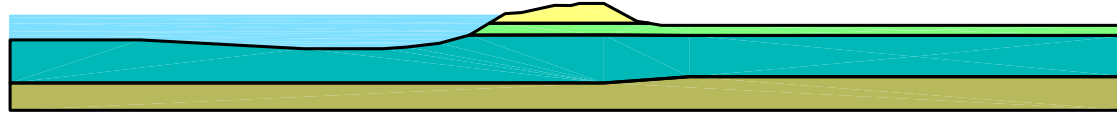

Detail

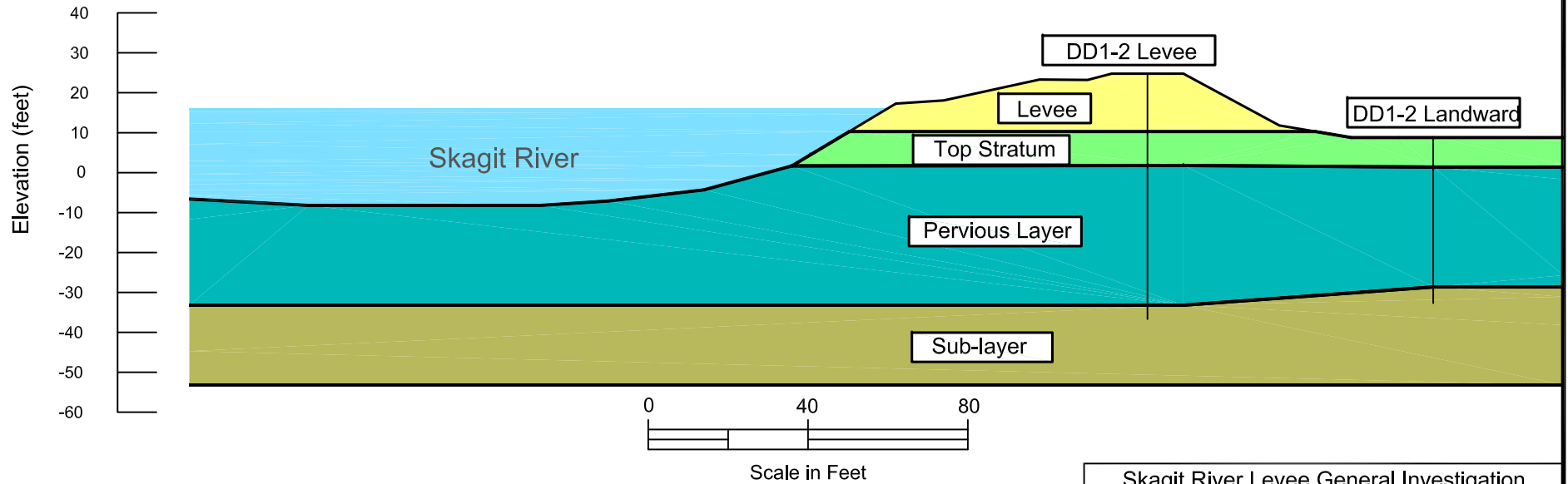

Skagit River Levee General Investigation
 Levee Risk and Reliability Analysis
 Skagit County, Washington

DD1-2R CROSS SECTION

January 2011

21-1-21199-003

SHANNON & WILSON, INC.
 Geotechnical and Environmental Consultants

FIG. 3

FIG. 3

Complete Model

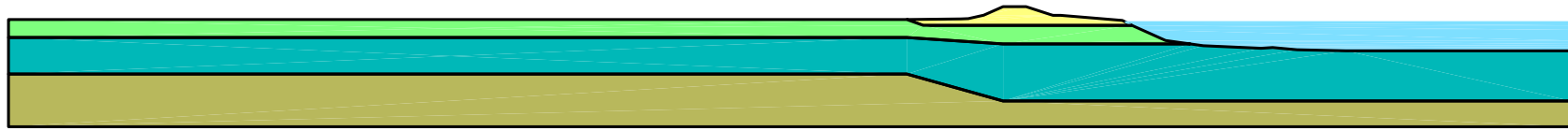

Detail

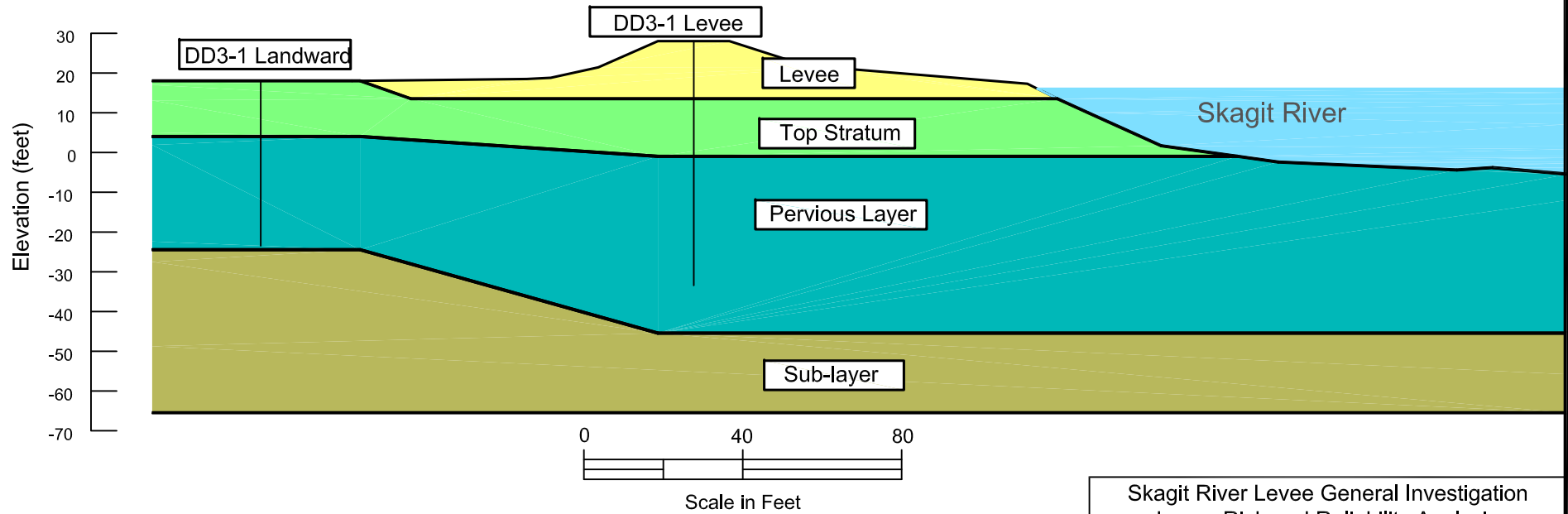

Skagit River Levee General Investigation
 Levee Risk and Reliability Analysis
 Skagit County, Washington

DD3-1L CROSS SECTION

January 2011

21-1-21199-003

SHANNON & WILSON, INC.
 Geotechnical and Environmental Consultants

FIG. 4

FIG. 4

Complete Model

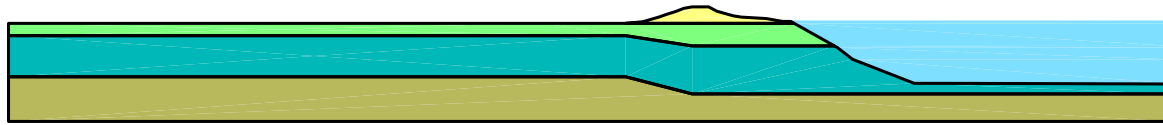

Detail

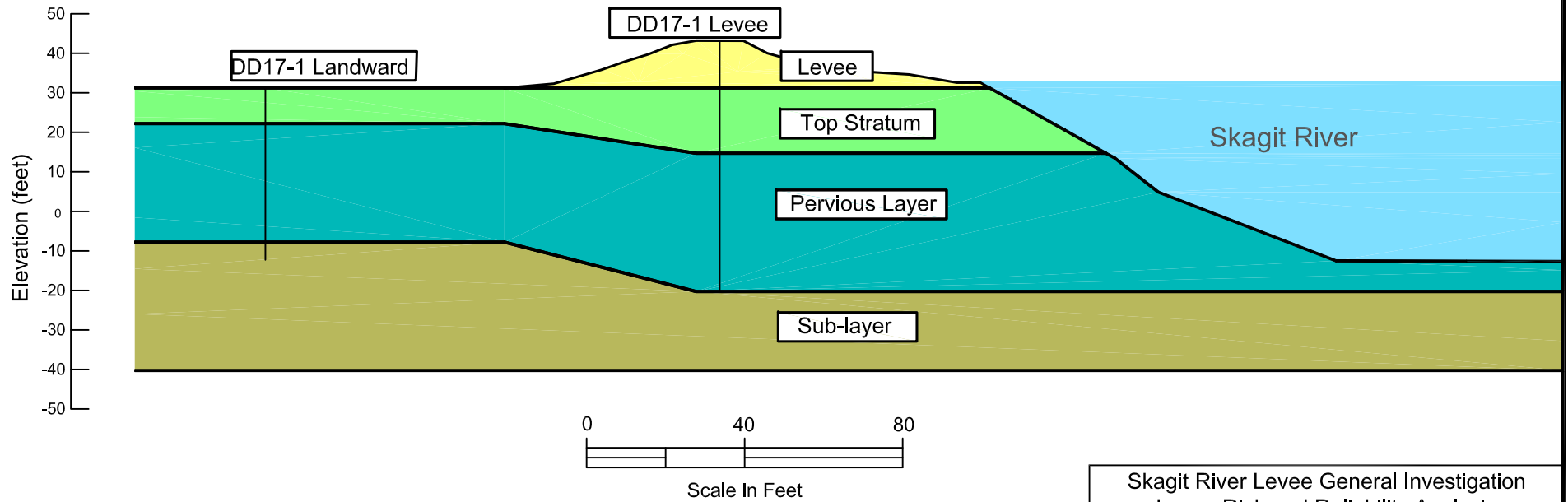

Skagit River Levee General Investigation
 Levee Risk and Reliability Analysis
 Skagit County, Washington

DD17-1L CROSS SECTION

January 2011

21-1-21199-003

SHANNON & WILSON, INC.
 Geotechnical and Environmental Consultants

FIG. 5

FIG. 5

Complete Model

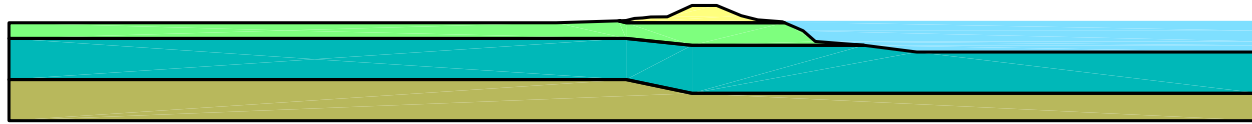

Detail

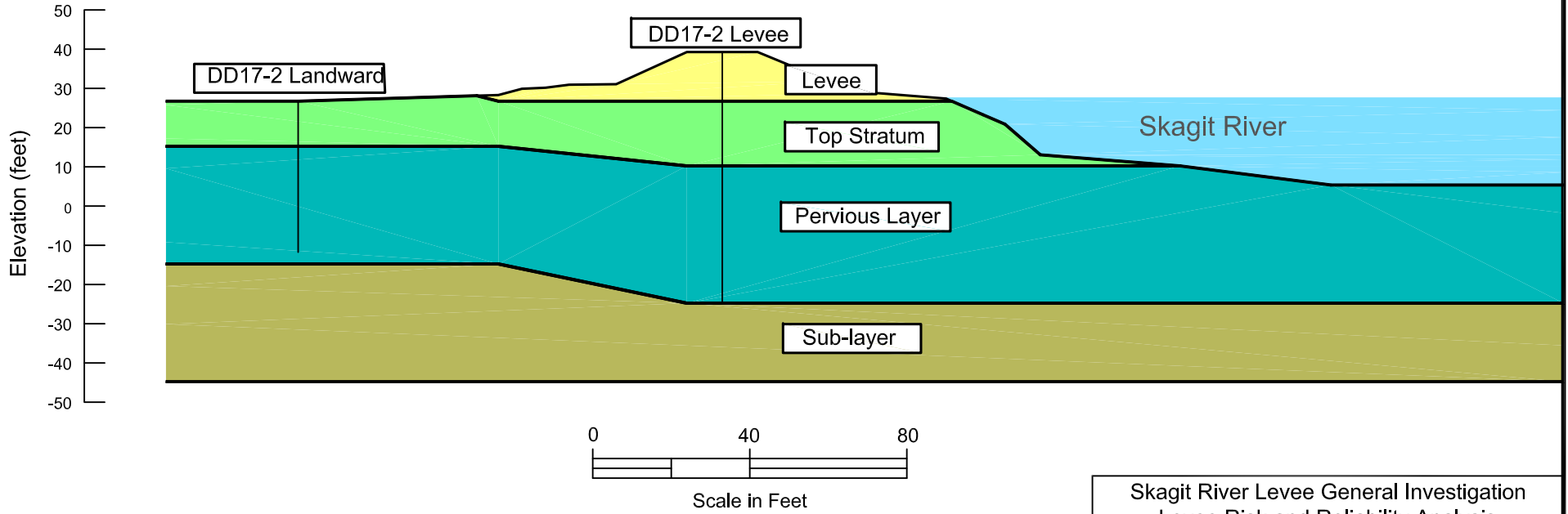

Skagit River Levee General Investigation
 Levee Risk and Reliability Analysis
 Skagit County, Washington

DD17-2L CROSS SECTION

January 2011

21-1-21199-003

SHANNON & WILSON, INC.
 Geotechnical and Environmental Consultants

FIG. 6

FIG. 6

Complete Model

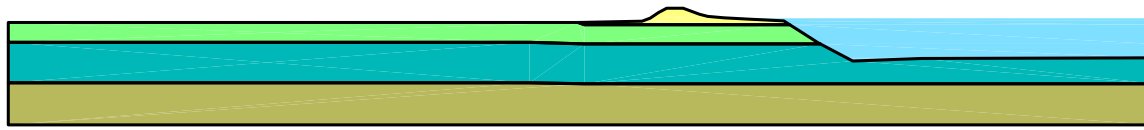

Detail

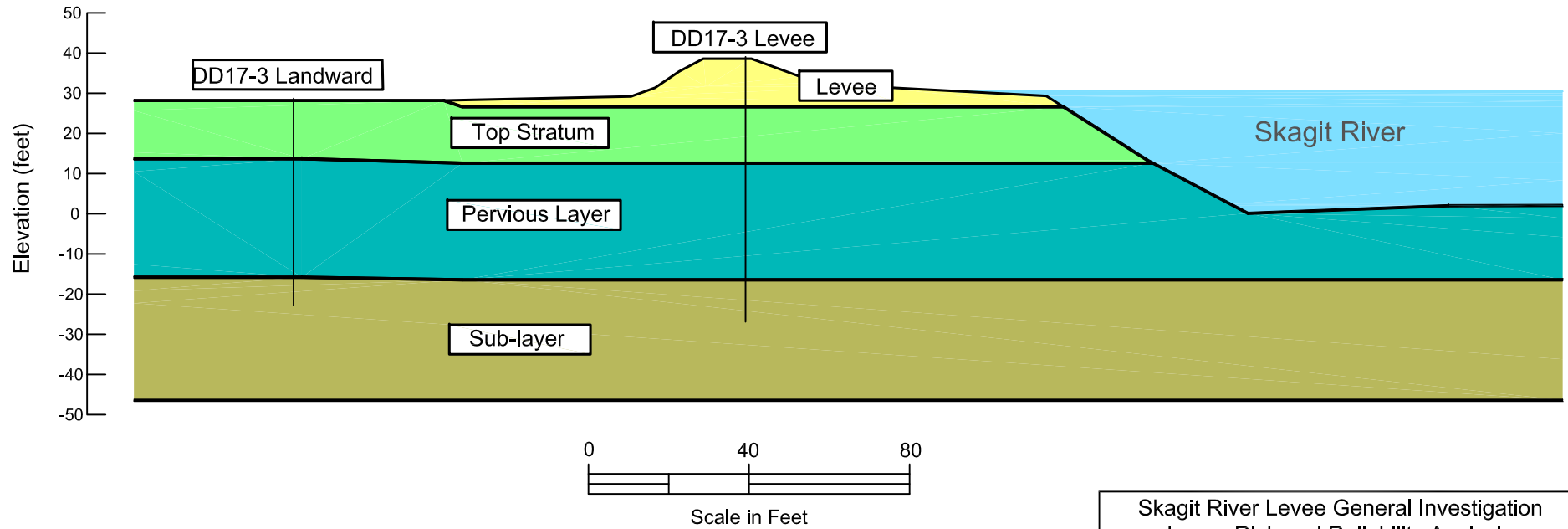

Skagit River Levee General Investigation
 Levee Risk and Reliability Analysis
 Skagit County, Washington

DD17-3L CROSS SECTION

January 2011

21-1-21199-003

SHANNON & WILSON, INC.
 Geotechnical and Environmental Consultants

FIG. 7

FIG. 7

Complete Model

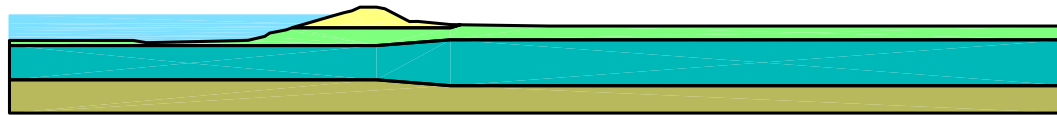

Detail

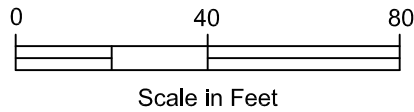
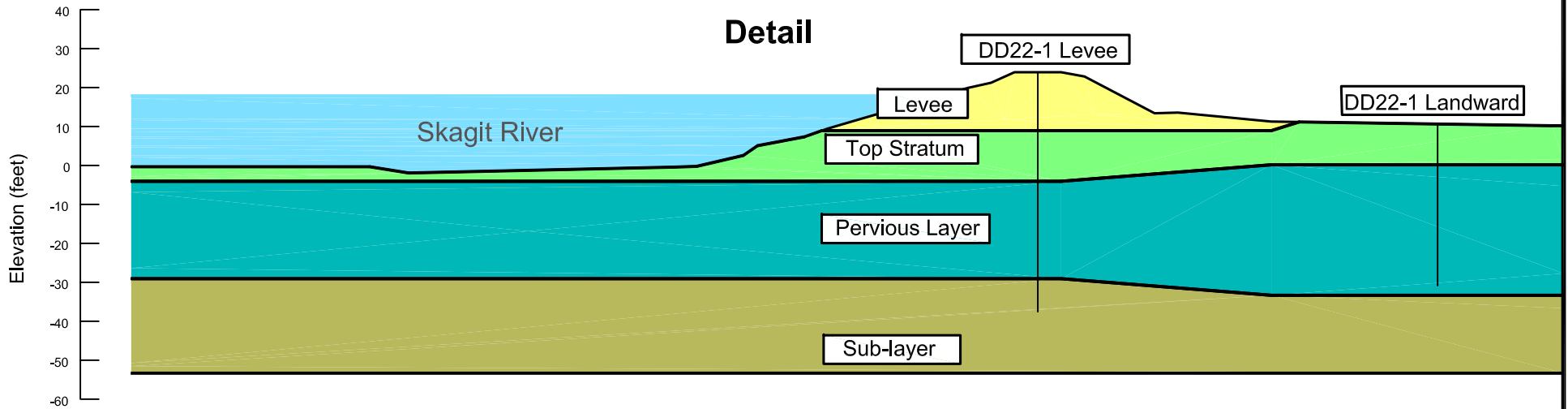

Skagit River Levee General Investigation
Levee Risk and Reliability Analysis
Skagit County, Washington

DD22-1R CROSS SECTION

January 2011

21-1-21199-003

SHANNON & WILSON, INC.
Geotechnical and Environmental Consultants

FIG. 8

FIG. 8

Complete Model

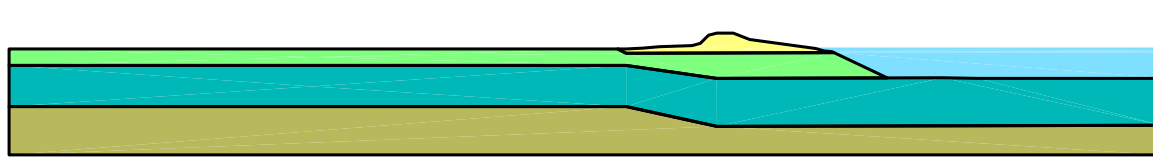

Detail

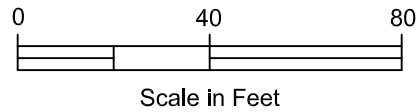
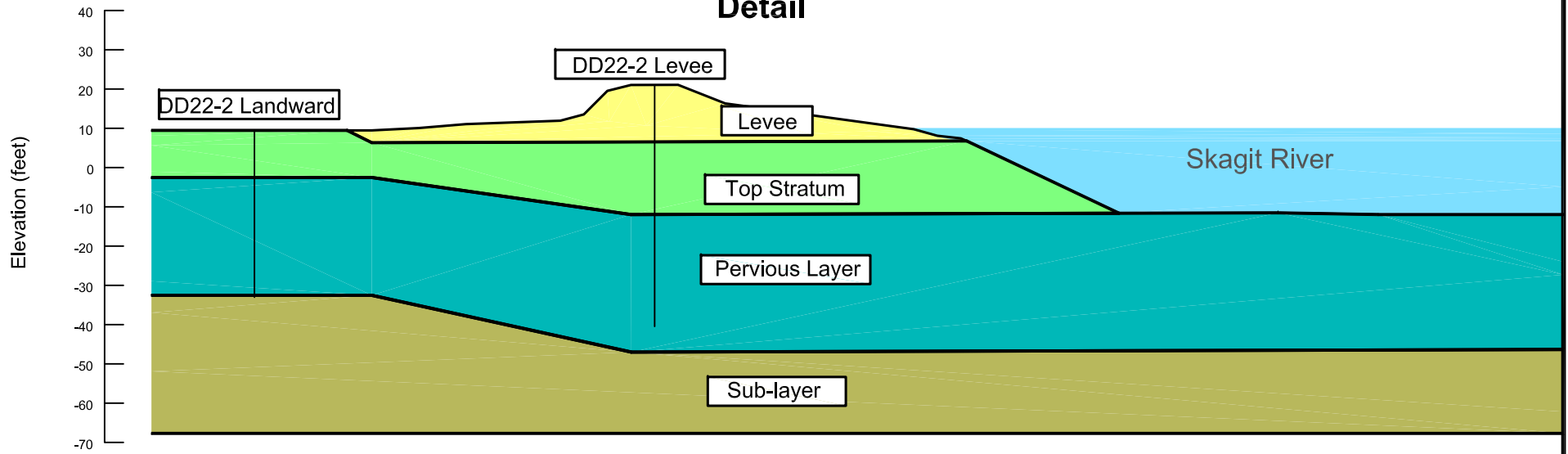

Skagit River Levee General Investigation
 Levee Risk and Reliability Analysis
 Skagit County, Washington

DD22-2L CROSS SECTION

January 2011

21-1-21199-003

SHANNON & WILSON, INC.
 Geotechnical and Environmental Consultants

FIG. 9

FIG. 9

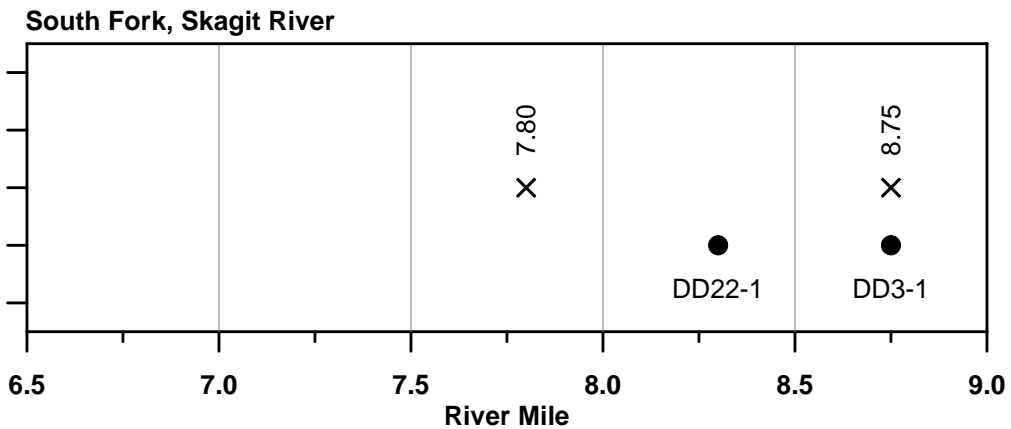
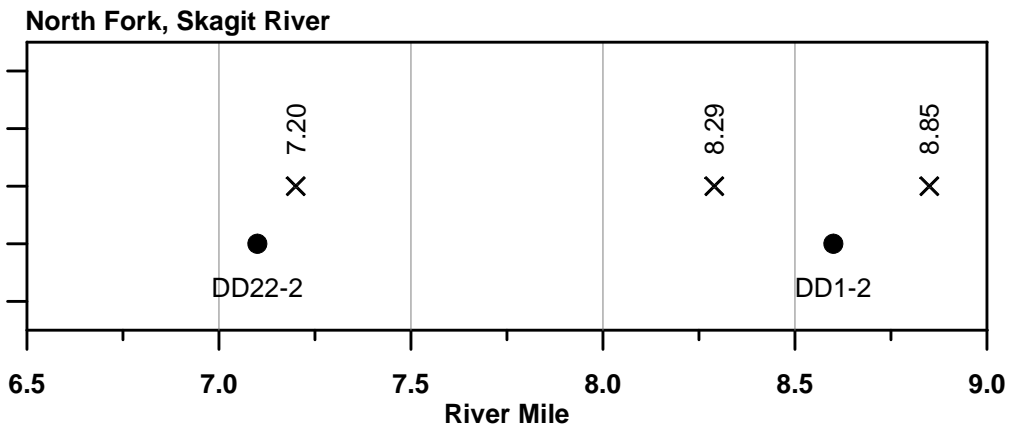
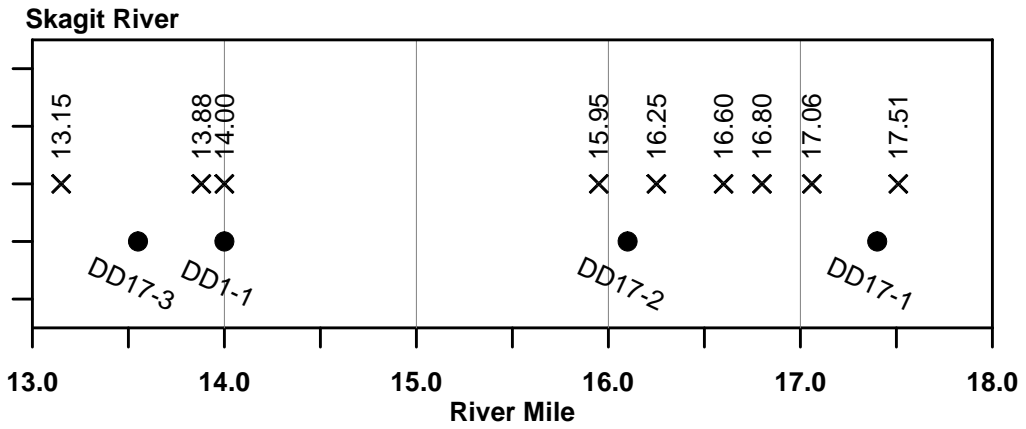

- LEGEND**
- Analysis Location
 - X Bathymetry Measurement Location

Skagit River Levee General Investigation Levee Risk and Reliability Analysis Skagit County, Washington	
BATHYMETRY MEASUREMENT AND ANALYSIS LOCATIONS	
January 2011	21-1-21199-003
SHANNON & WILSON, INC. <small>Geotechnical and Environmental Consultants</small>	FIG. 10

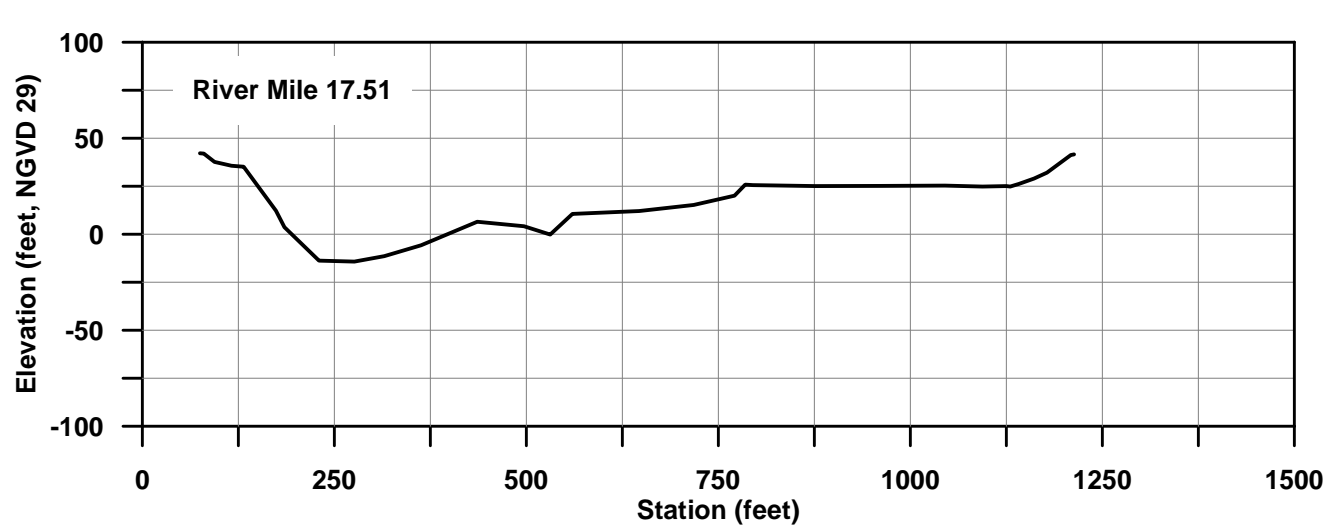
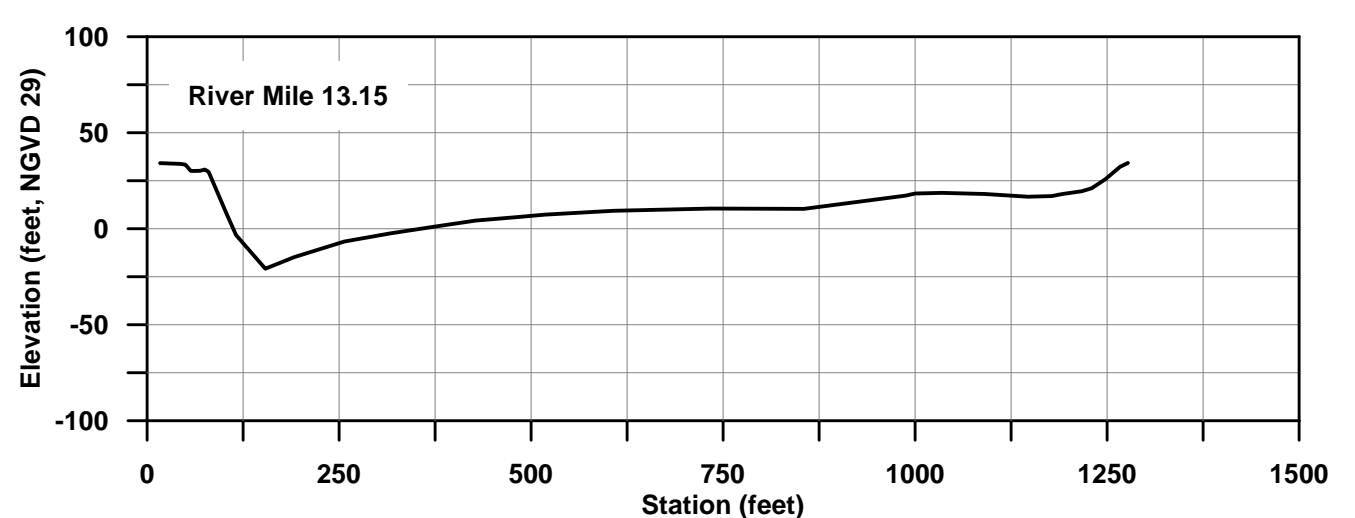
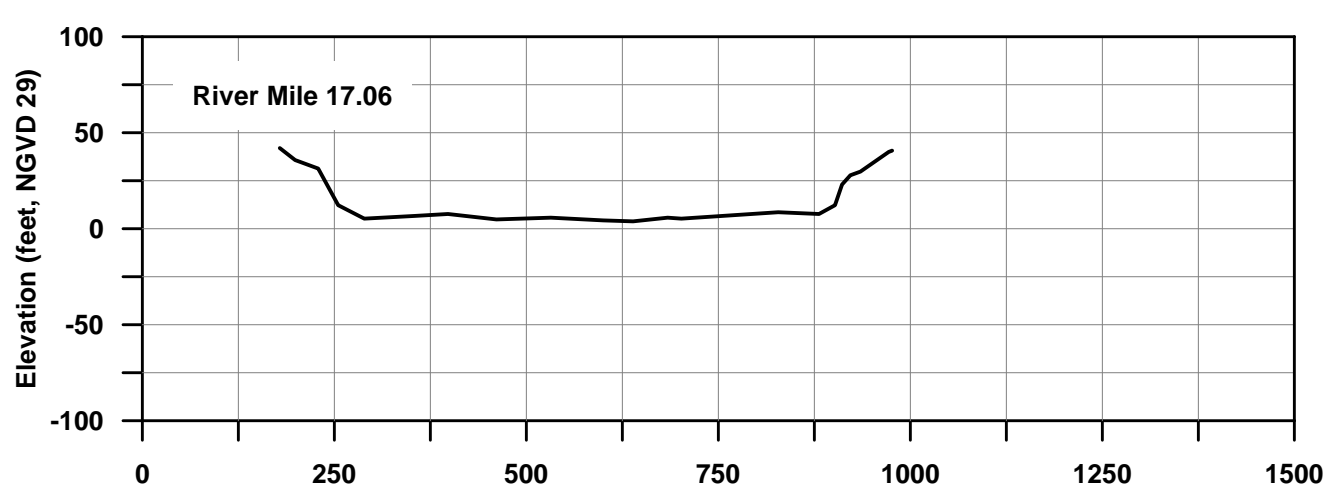
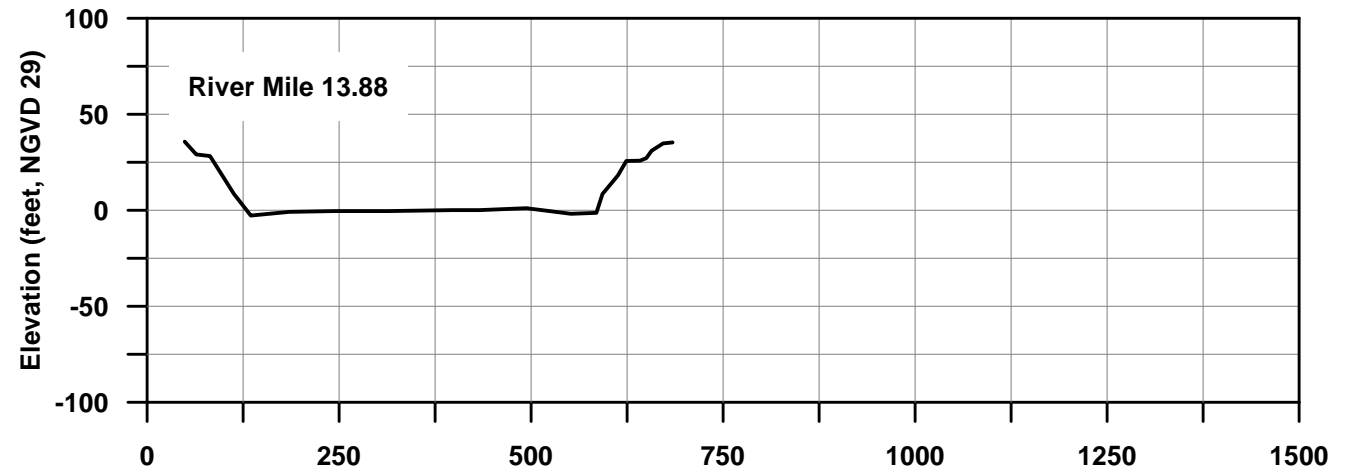
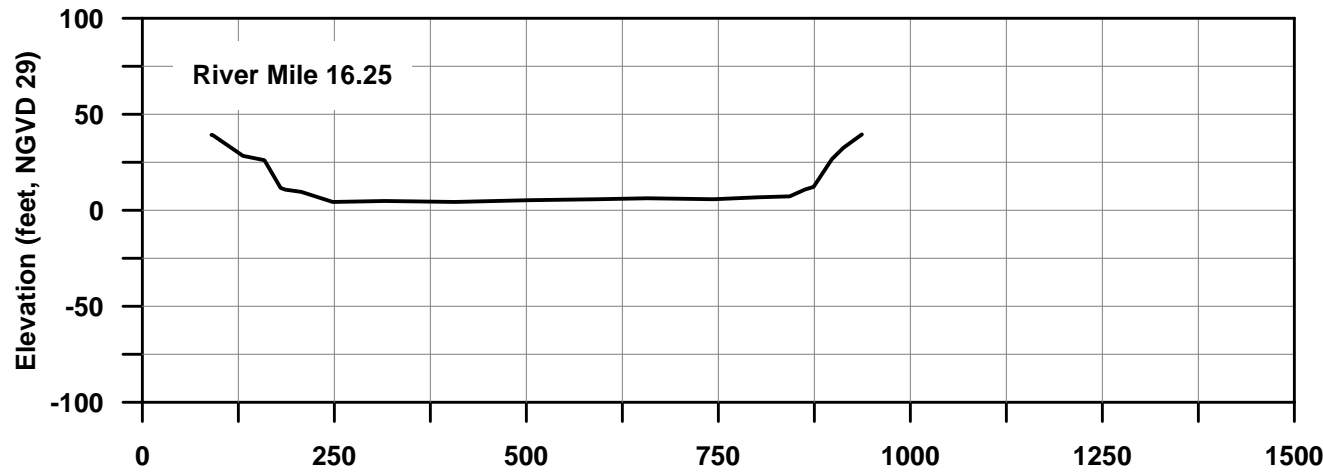
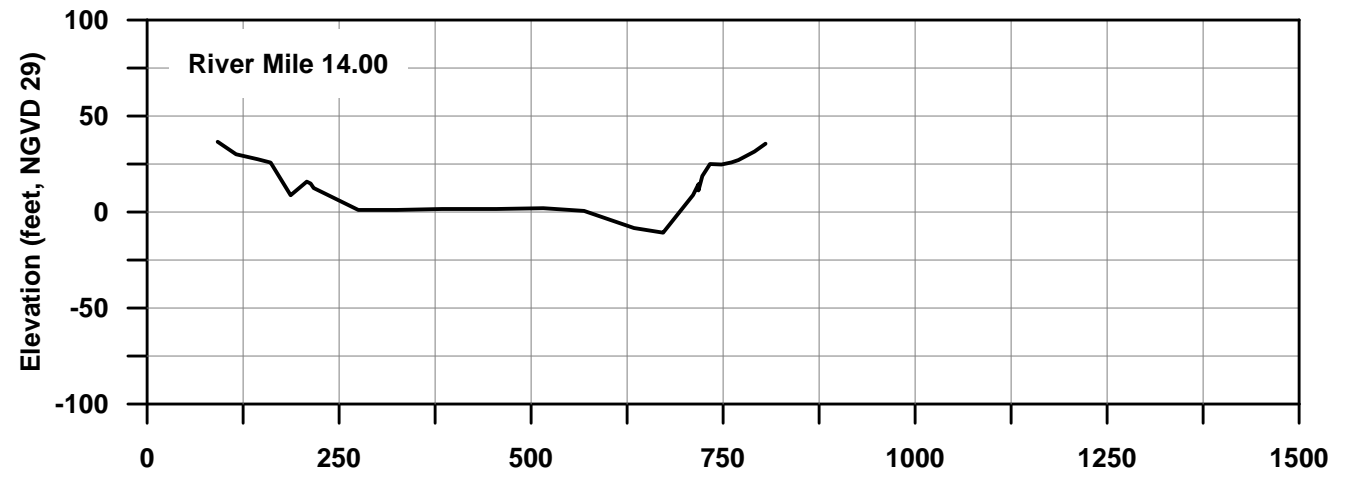
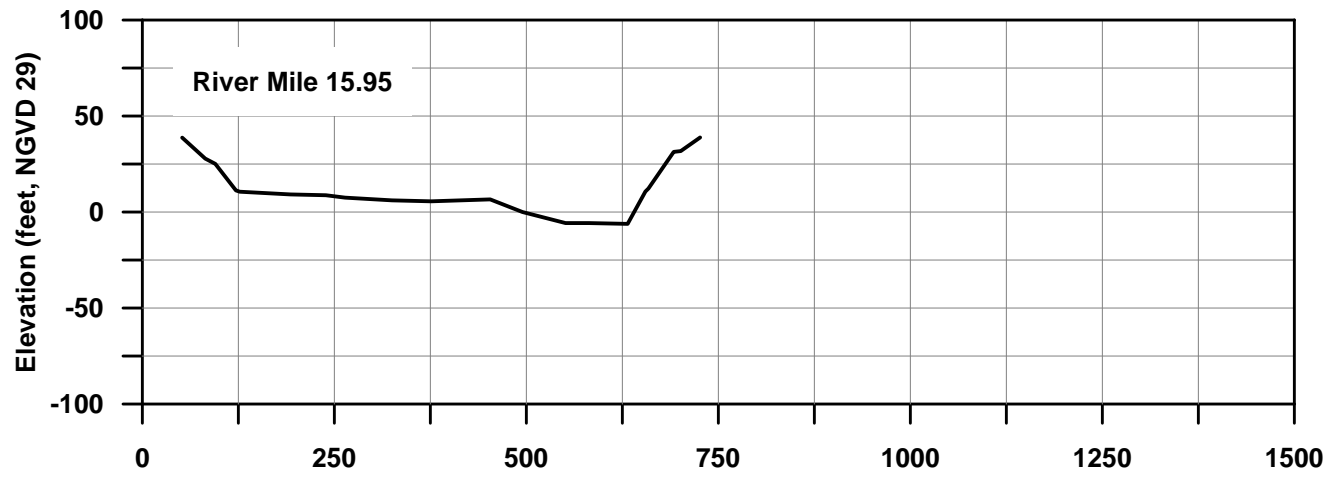

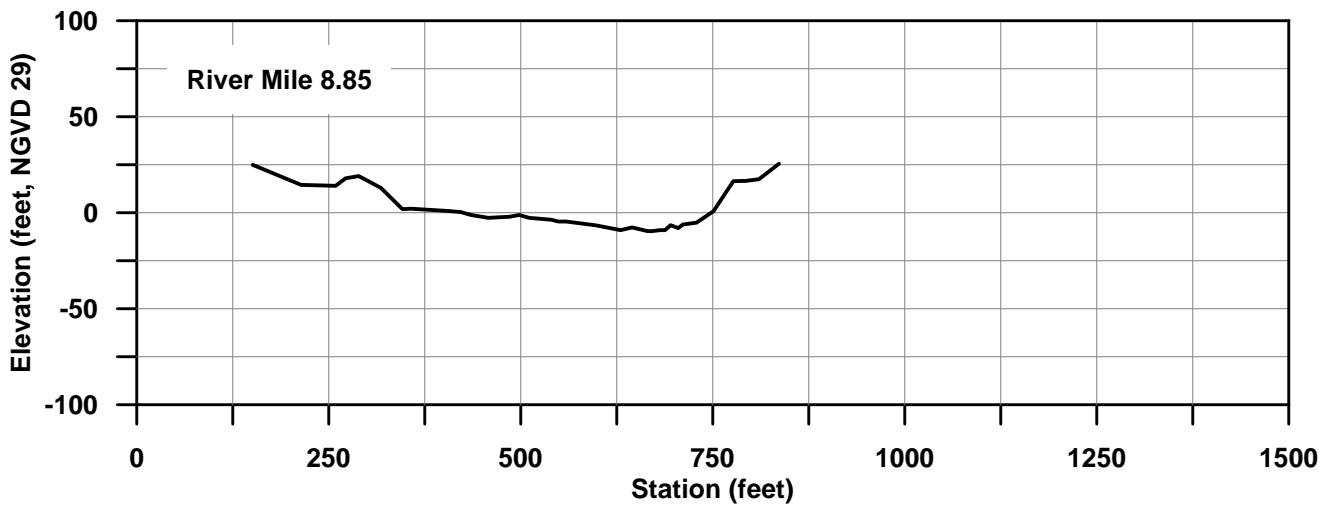
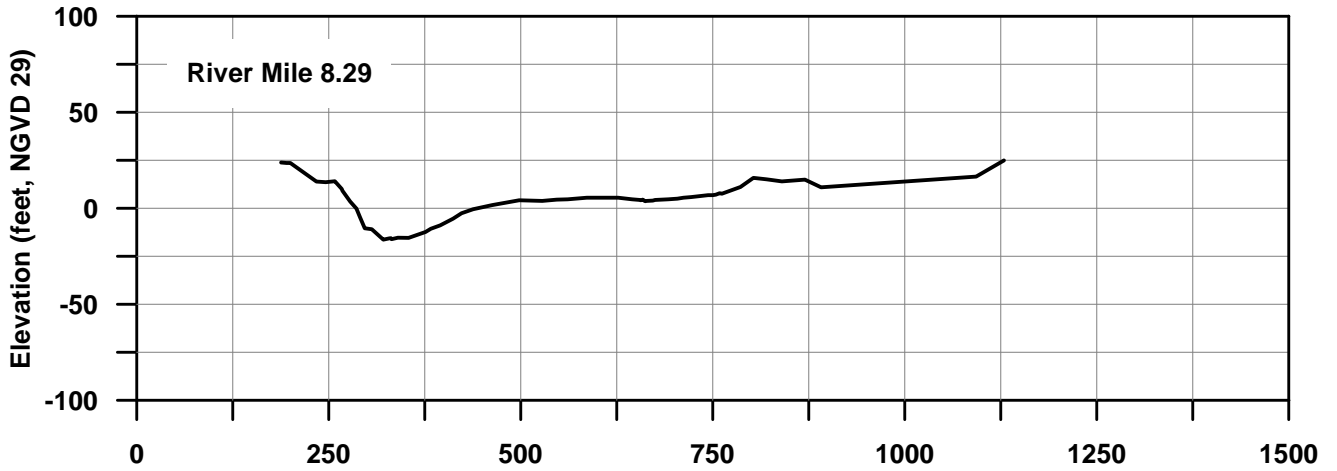
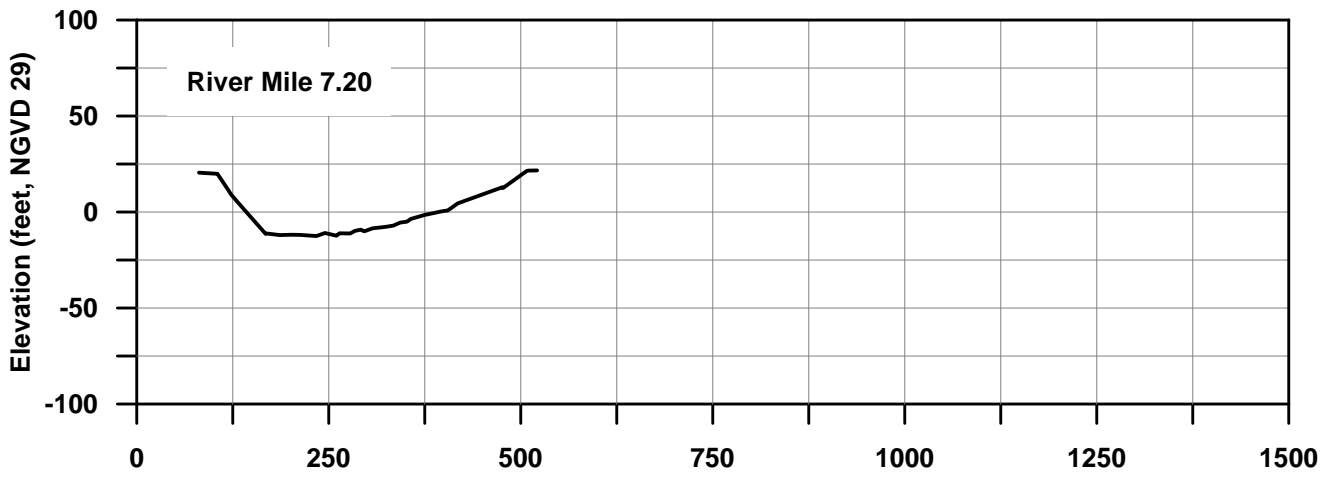

Skagit River Levee General Investigation
 Levee Risk and Reliability Analysis
 Skagit County, Washington

**NORTH FORK SKAGIT RIVER
 BATHYMETRY MEASUREMENTS**

January 2011

21-1-21199-003

SHANNON & WILSON, INC.
 Geotechnical and Environmental Consultants

FIG. 12

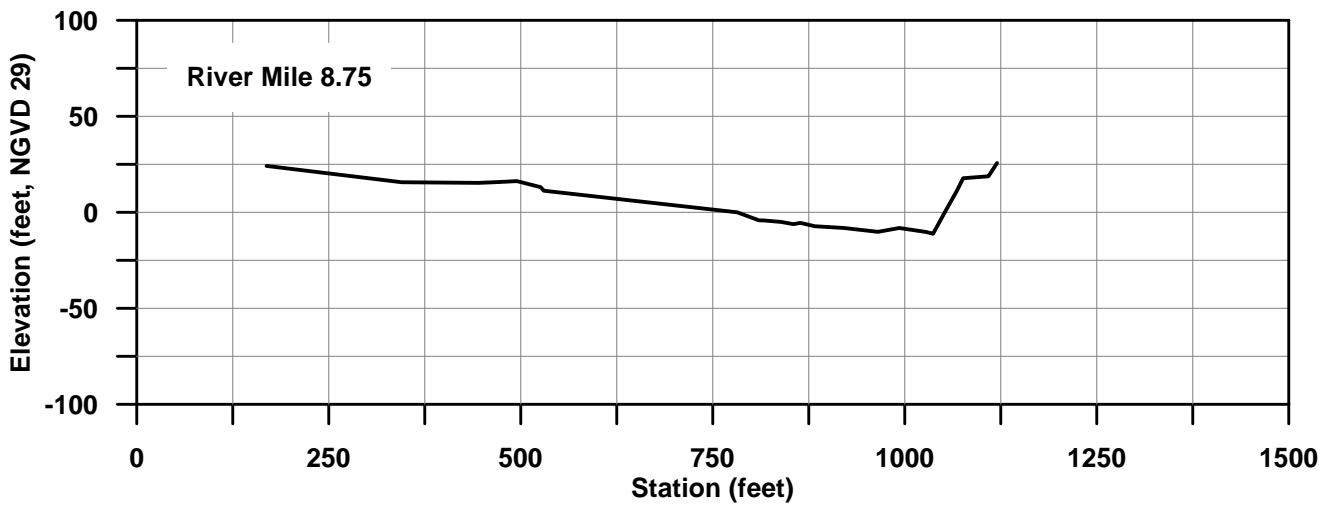
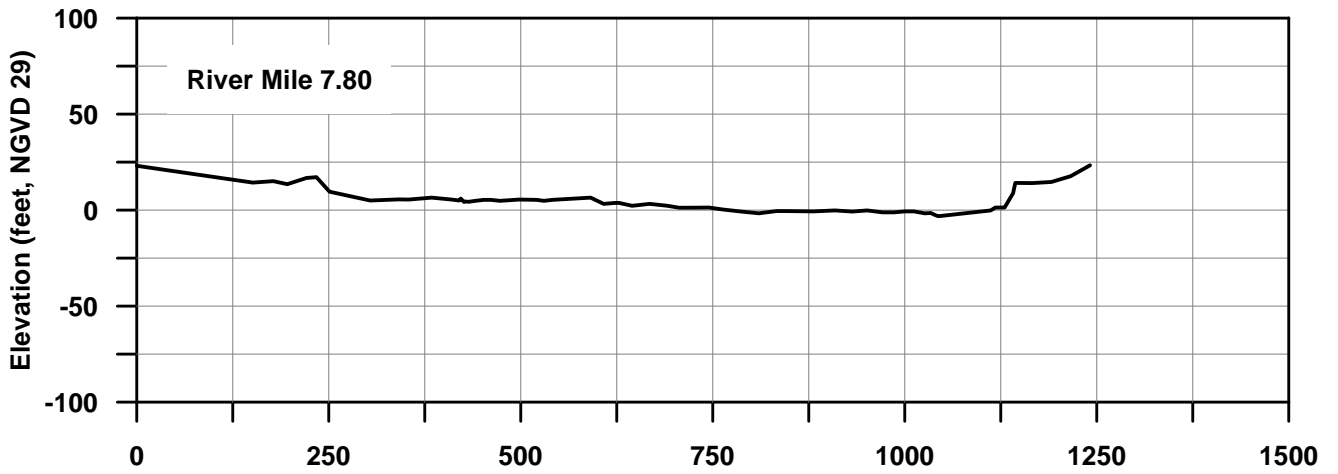

Skagit River Levee General Investigation
 Levee Risk and Reliability Analysis
 Skagit County, Washington

**SOUTH FORK SKAGIT RIVER
 BATHYMETRY MEASUREMENTS**

January 2011

21-1-21199-003

SHANNON & WILSON, INC.
 Geotechnical and Environmental Consultants

FIG. 13

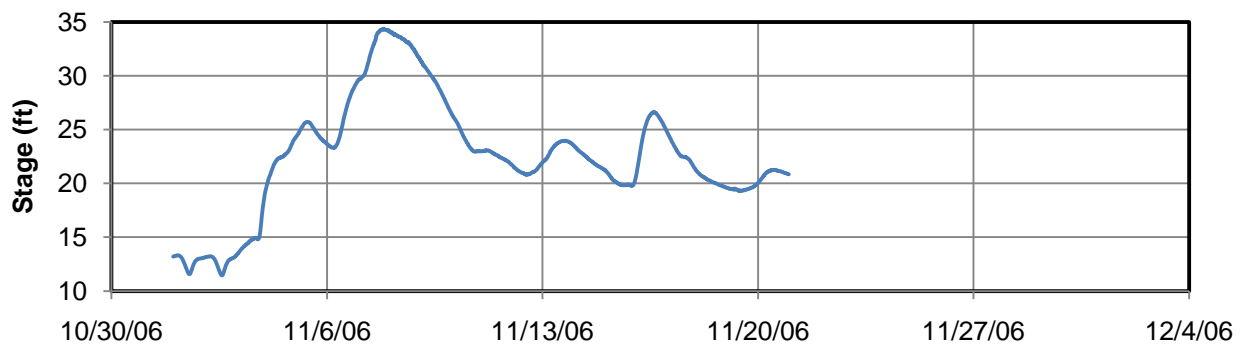
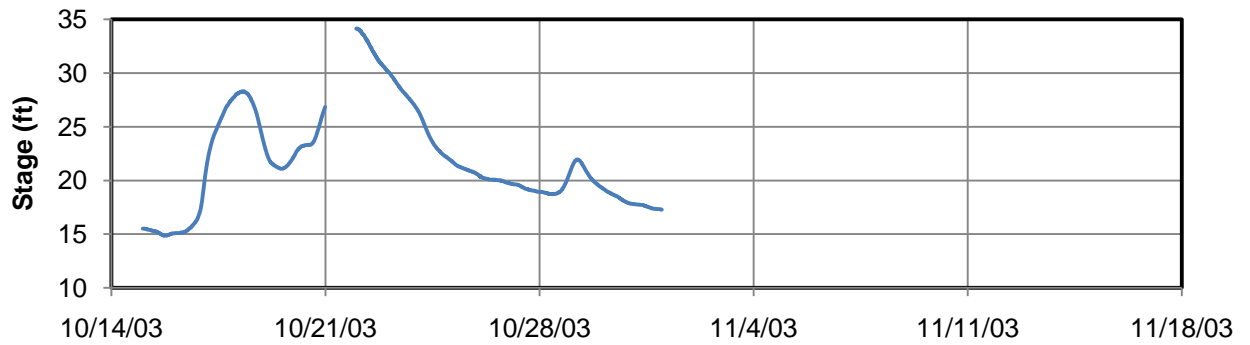
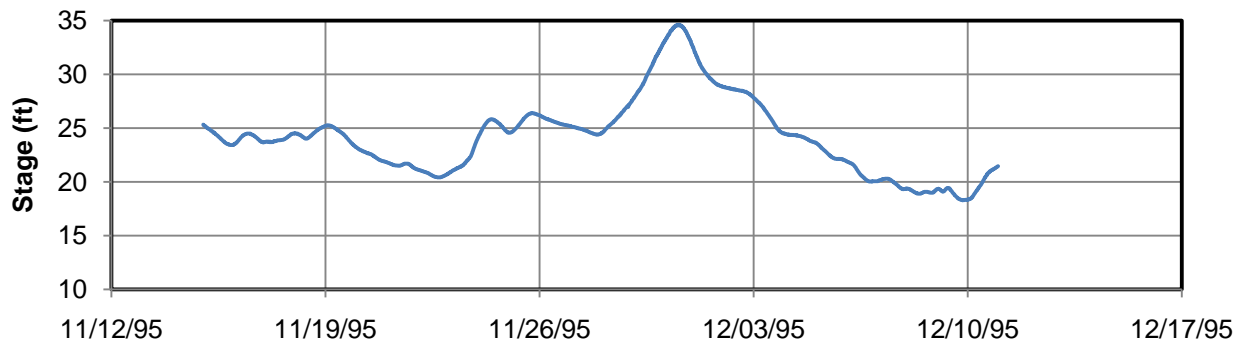
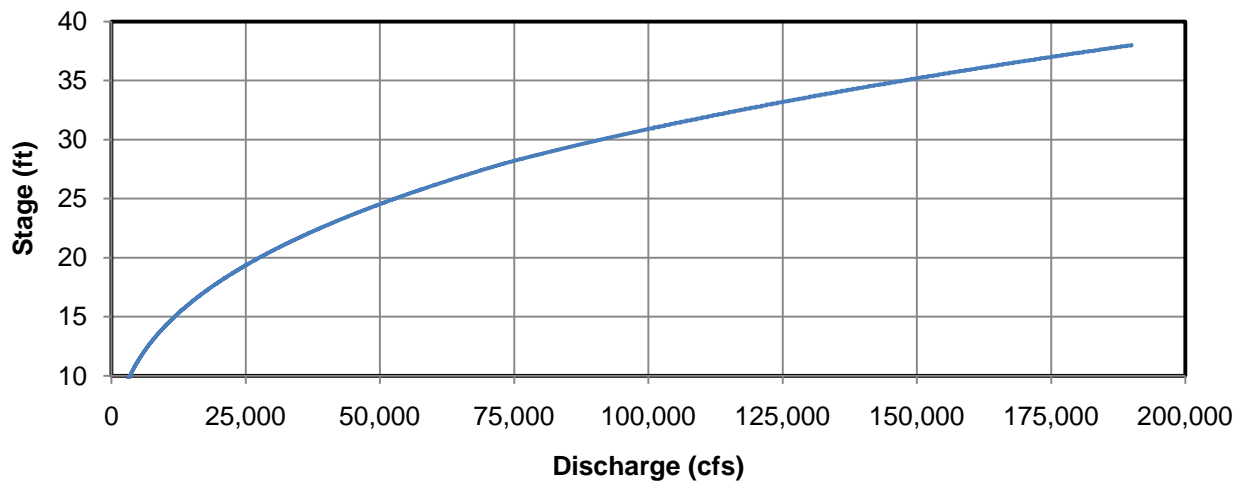

Skagit River Levee General Investigation
Levee Risk and Reliability Analysis
Skagit County, Washington

**SKAGIT RIVER RATING CURVE AND
HYDROGRAPHS**

January 2011 21-1-21199-003

SHANNON & WILSON, INC. Geotechnical and Environmental Consultants	FIG. 14
---	----------------

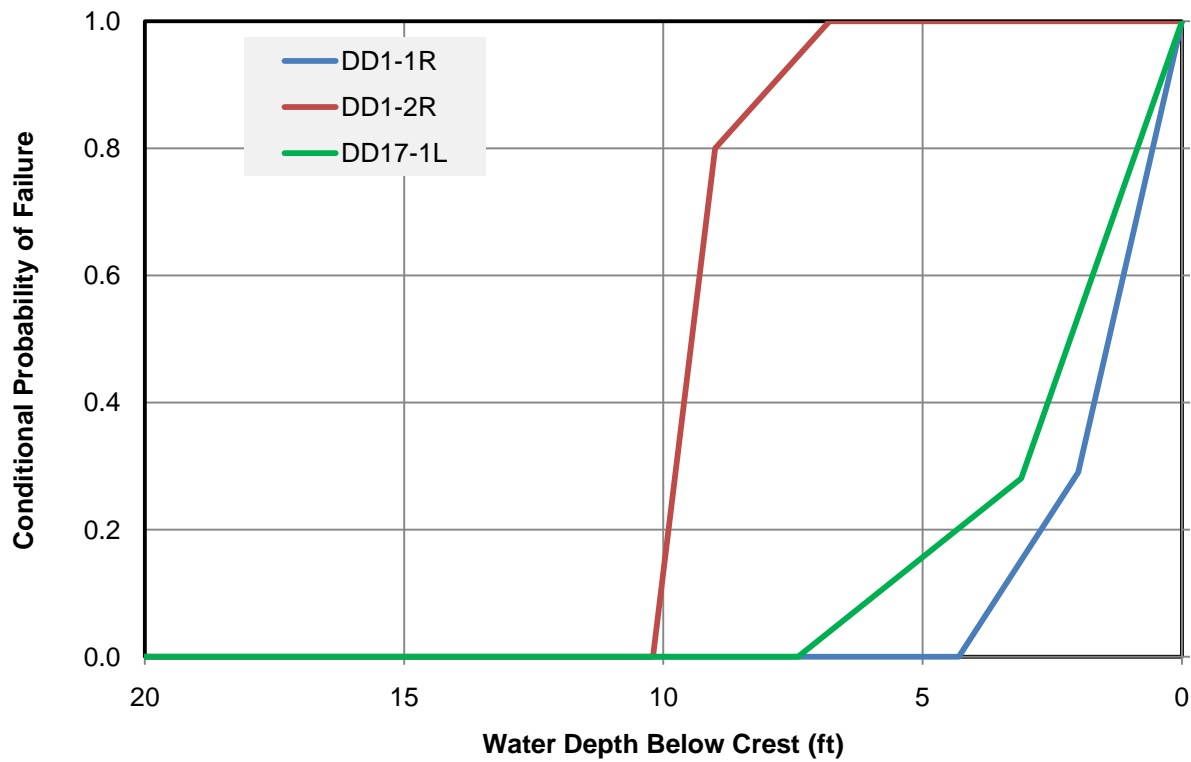

NOTE:

The conditional probabilities of underseepage failure at analysis sections DD3-1L, DD17-2L, DD17-3L, DD22-1R, and DD22-2L were near zero for all river stages and are not included in this graph.

Skagit River Levee General Investigation
 Levee Risk and Reliability Analysis
 Skagit County, Washington

**DEPTH-NORMALIZED
 UNDERSEEPAGE FAILURE
 PROBABILITIES**

January 2011

21-1-21199-003

SHANNON & WILSON, INC.
 Geotechnical and Environmental Consultants

FIG. 15

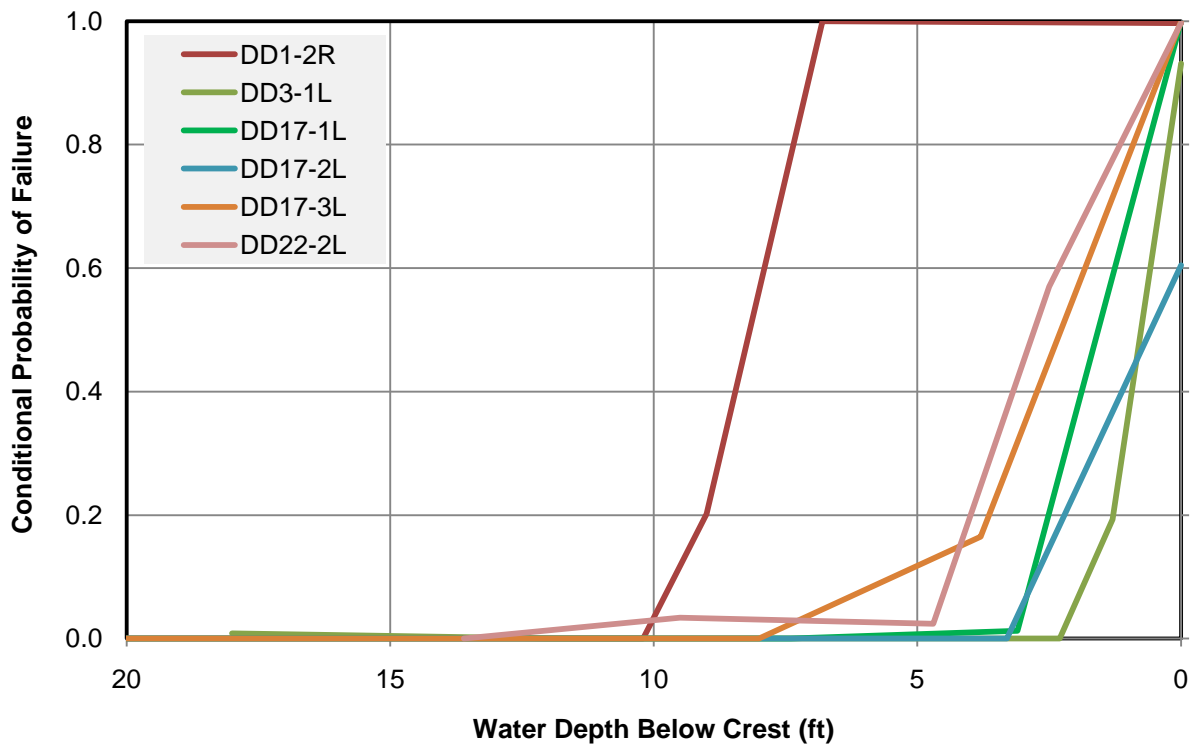

NOTE:

The conditional probabilities of static landside failure at analysis sections DD1-1R and DD22-1R were near zero for all river stages and are not included in this graph.

Skagit River Levee General Investigation
 Levee Risk and Reliability Analysis
 Skagit County, Washington

**DEPTH-NORMALIZED LANDSIDE
 STATIC FAILURE PROBABILITIES**

January 2011

21-1-21199-003

SHANNON & WILSON, INC.
 Geotechnical and Environmental Consultants

FIG. 16

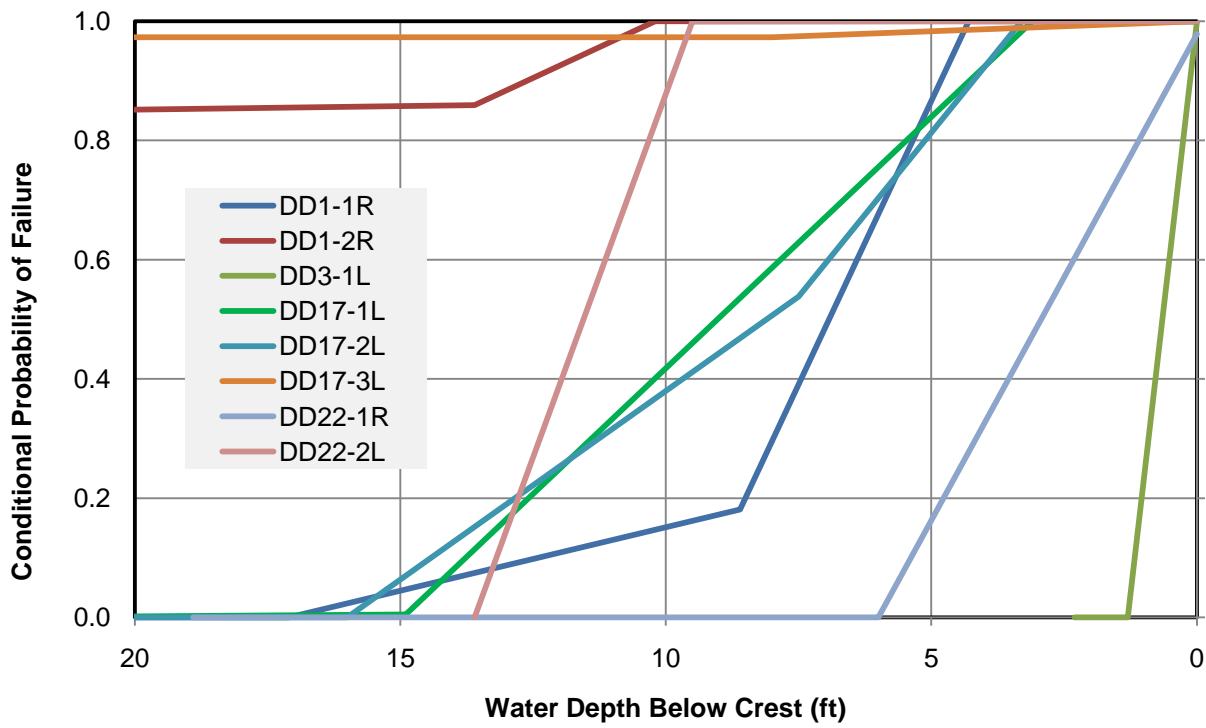

Skagit River Levee General Investigation
 Levee Risk and Reliability Analysis
 Skagit County, Washington

**DEPTH-NORMALIZED LANDSIDE
 SEISMIC FAILURE PROBABILITIES**

January 2011

21-1-21199-003

SHANNON & WILSON, INC.
 Geotechnical and Environmental Consultants

FIG. 17

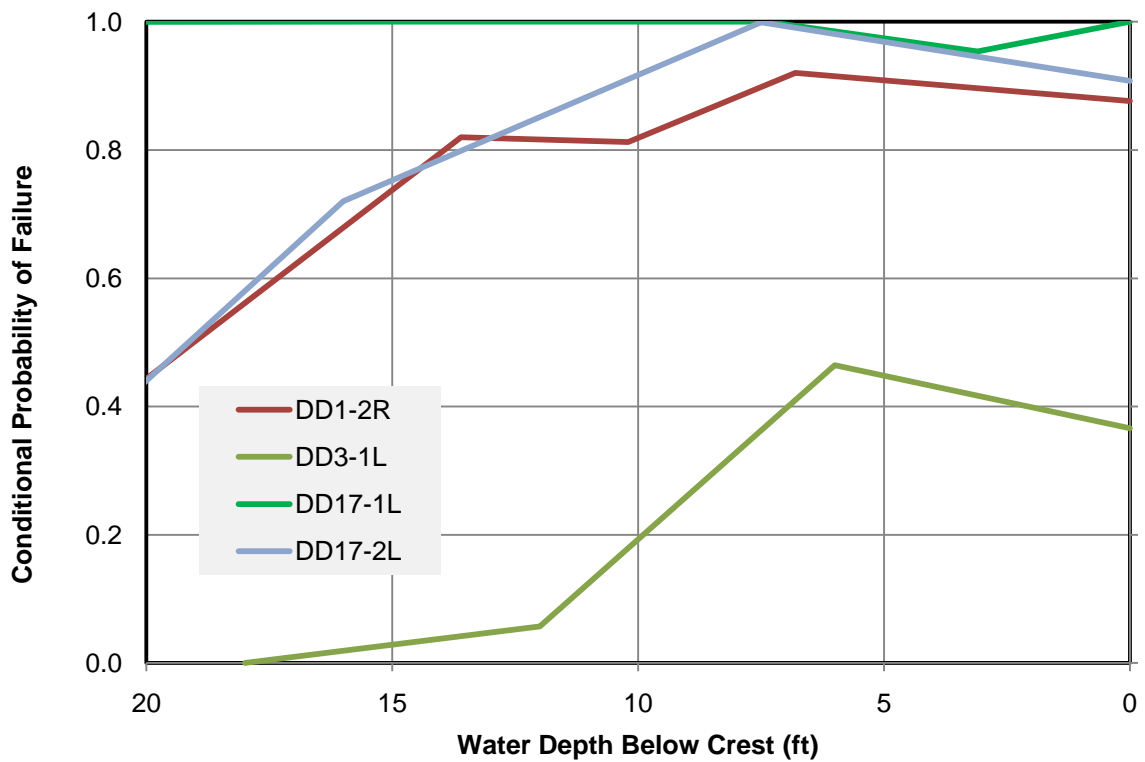
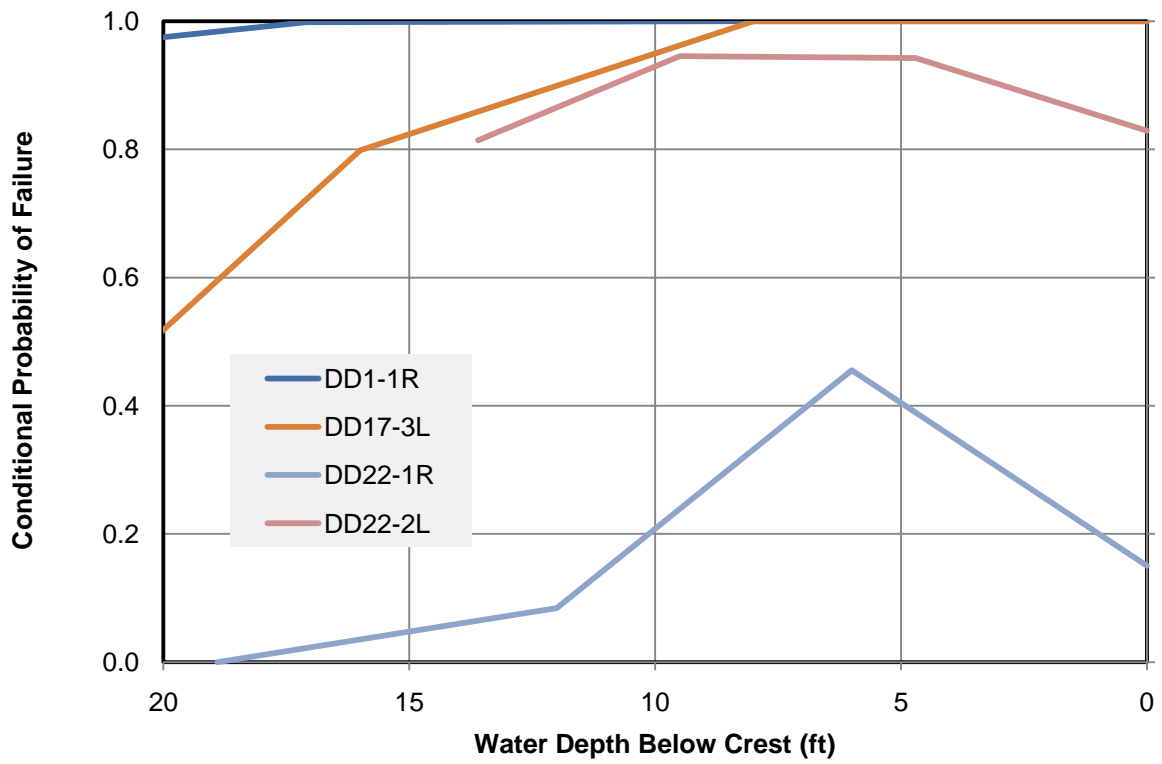

Skagit River Levee General Investigation
 Levee Risk and Reliability Analysis
 Skagit County, Washington

**DEPTH-NORMALIZED RIVERSIDE
 SEISMIC FAILURE PROBABILITIES**

January 2011

21-1-21199-003

SHANNON & WILSON, INC.
 Geotechnical and Environmental Consultants

FIG. 18

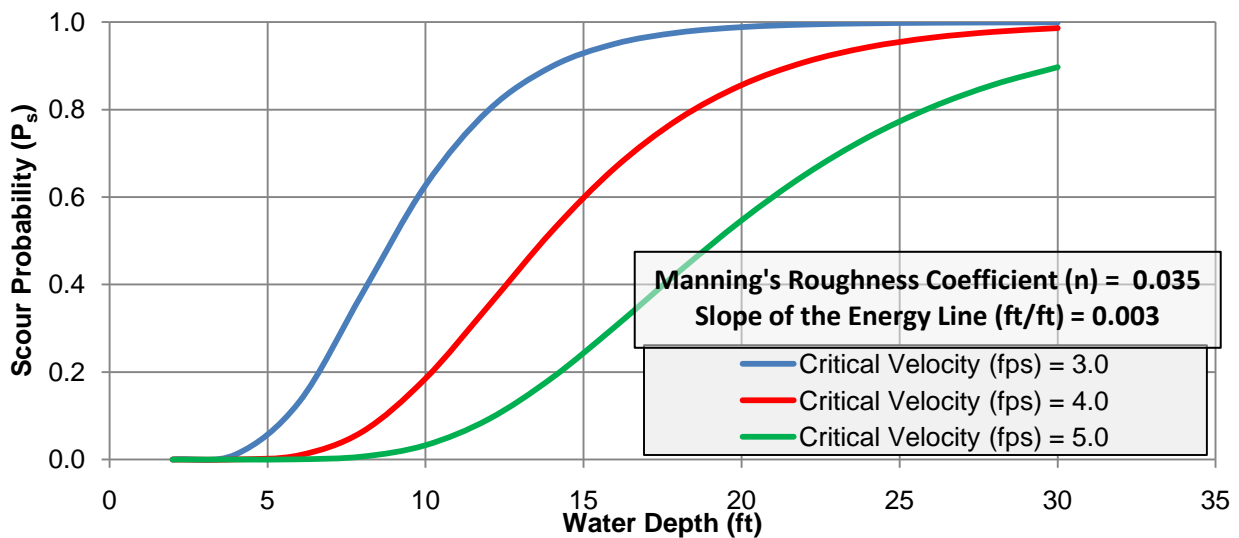
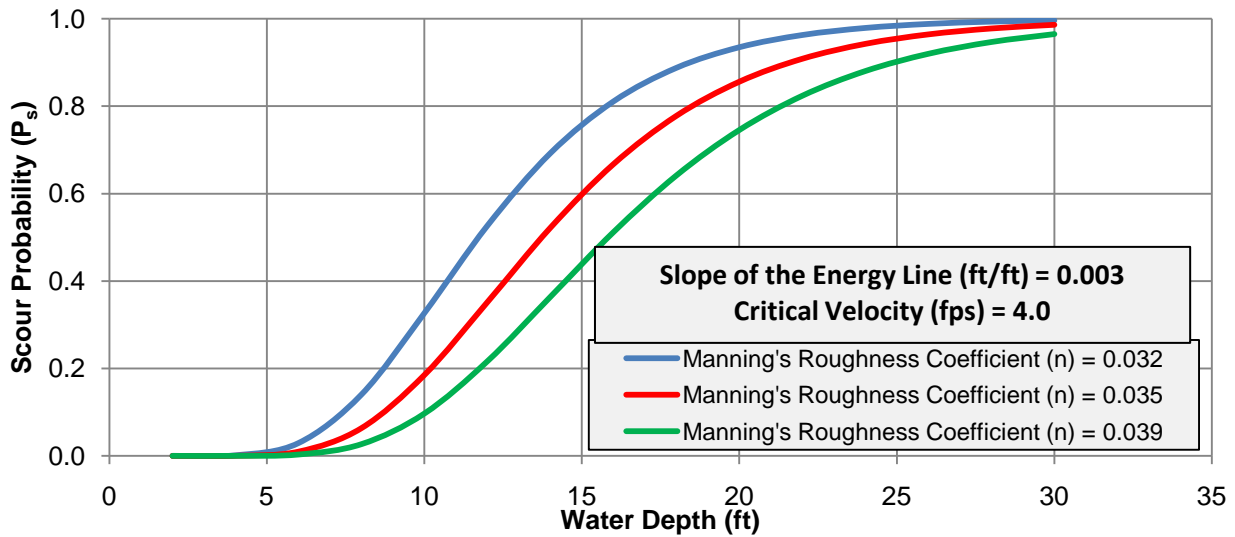
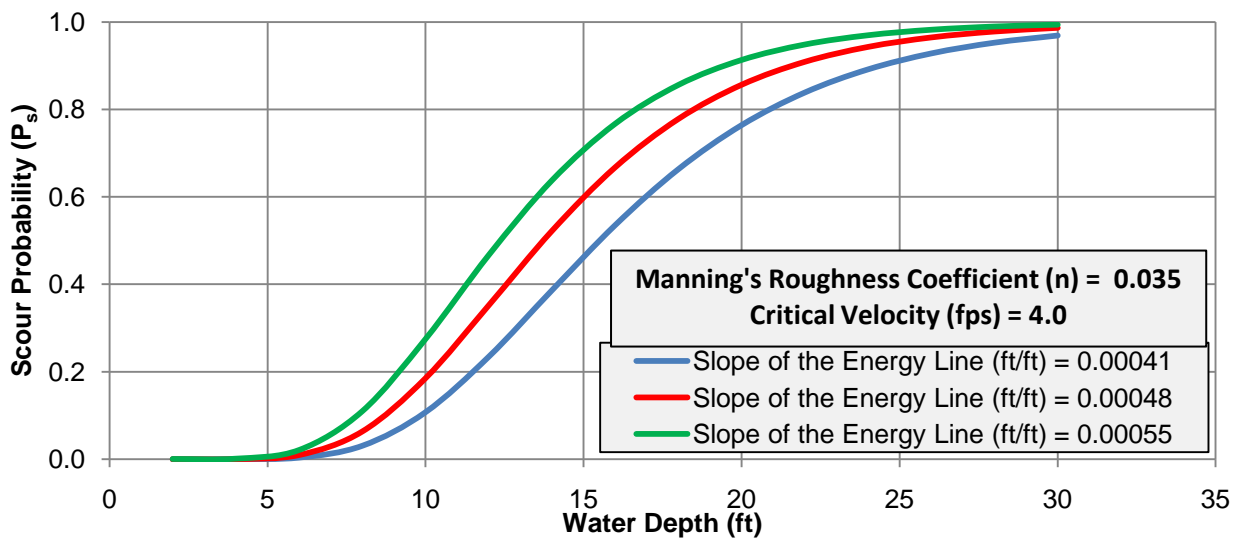

Skagit River Levee General Investigation
 Levee Risk and Reliability Analysis
 Skagit County, Washington

**SCOUR PROBABILITY
 VS WATER DEPTH
 SKAGIT RIVER**

January 2011

21-1-21199-

SHANNON & WILSON.
 Geotechnical and Environmental

FIG. 19

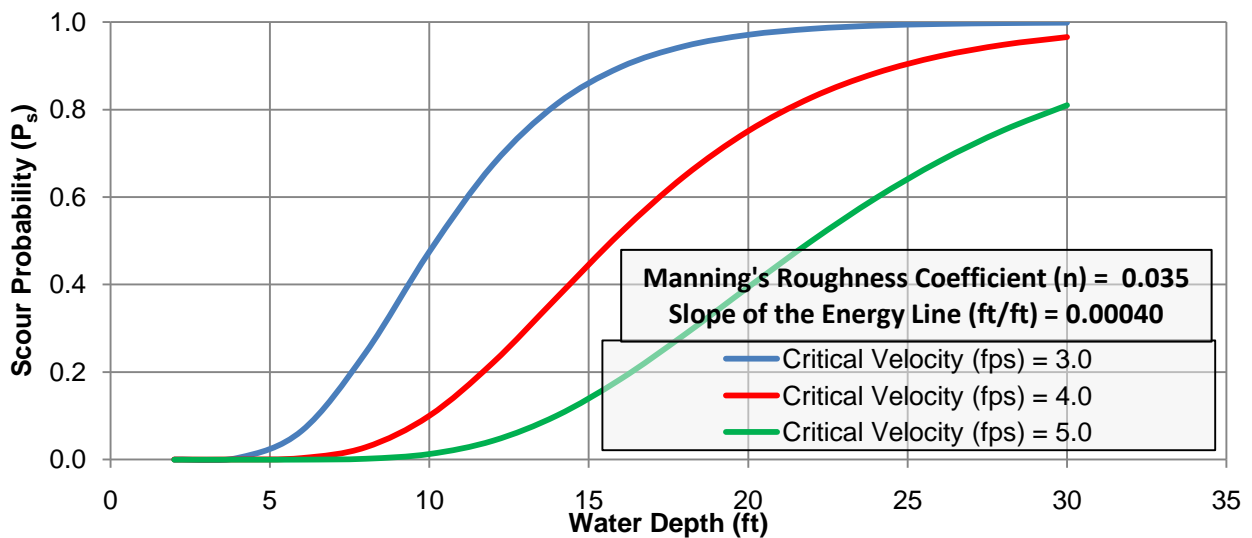
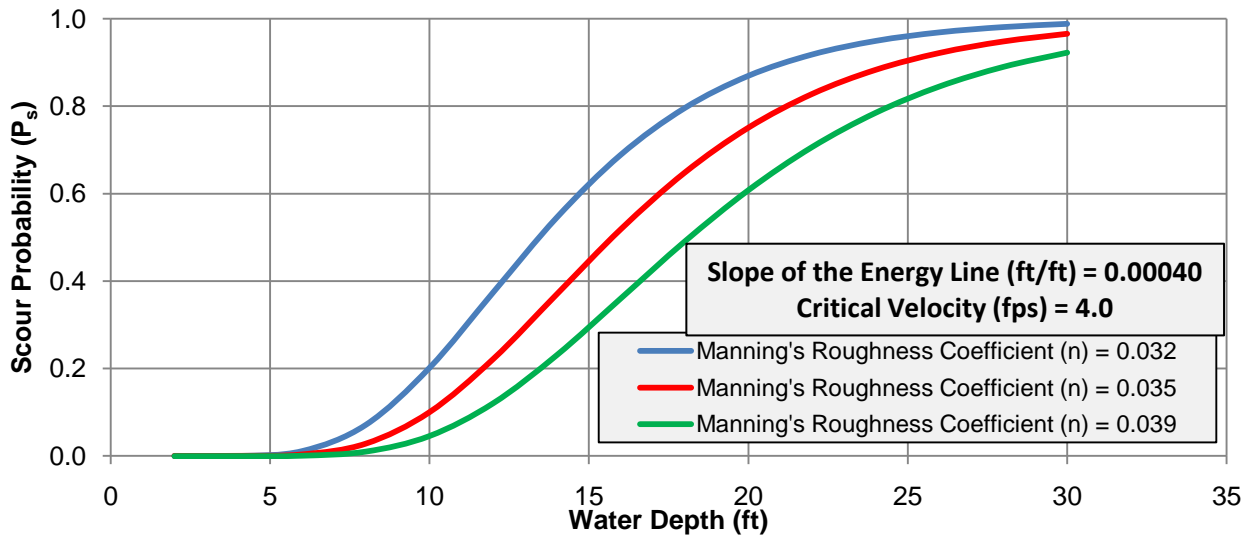
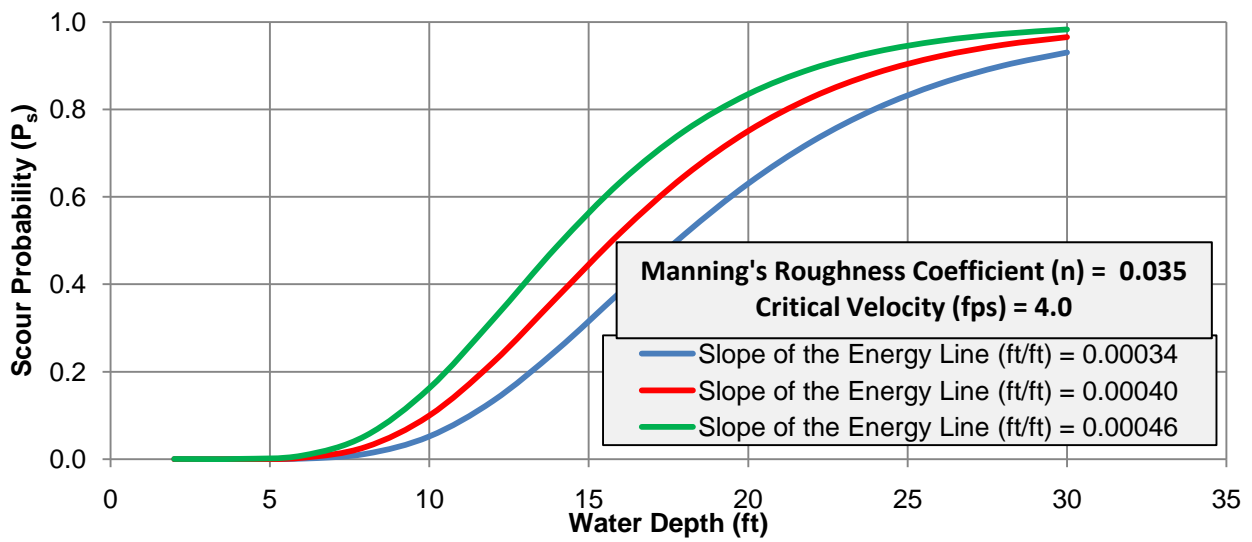

Skagit River Levee General Investigation
 Levee Risk and Reliability Analysis
 Skagit County, Washington

**SCOUR PROBABILITY
 VS WATER DEPTH
 NORTH AND SOUTH FORK**

January 2011

21-1-21199-

SHANNON & WILSON.
 Geotechnical and Environmental

FIG. 20

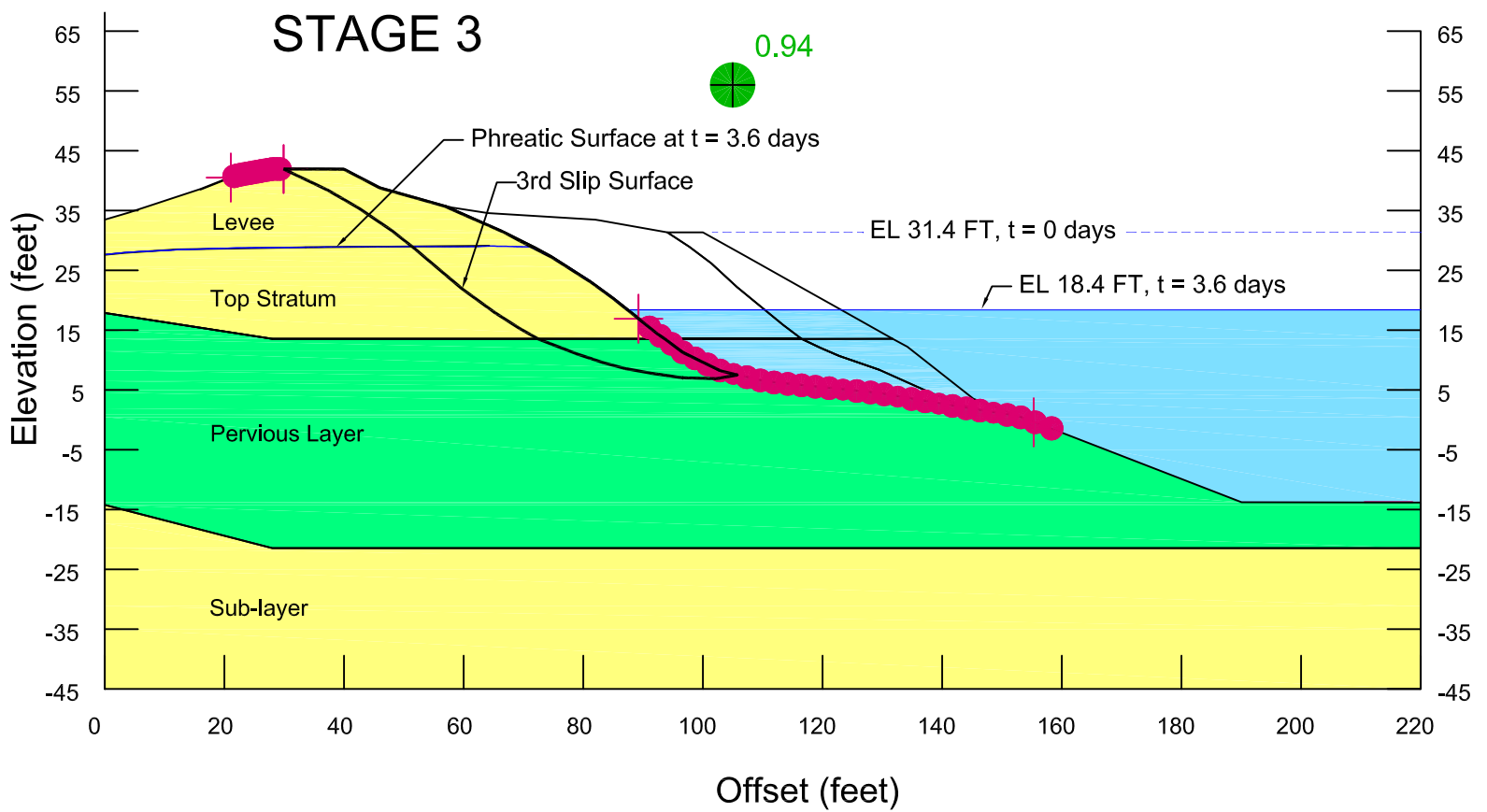
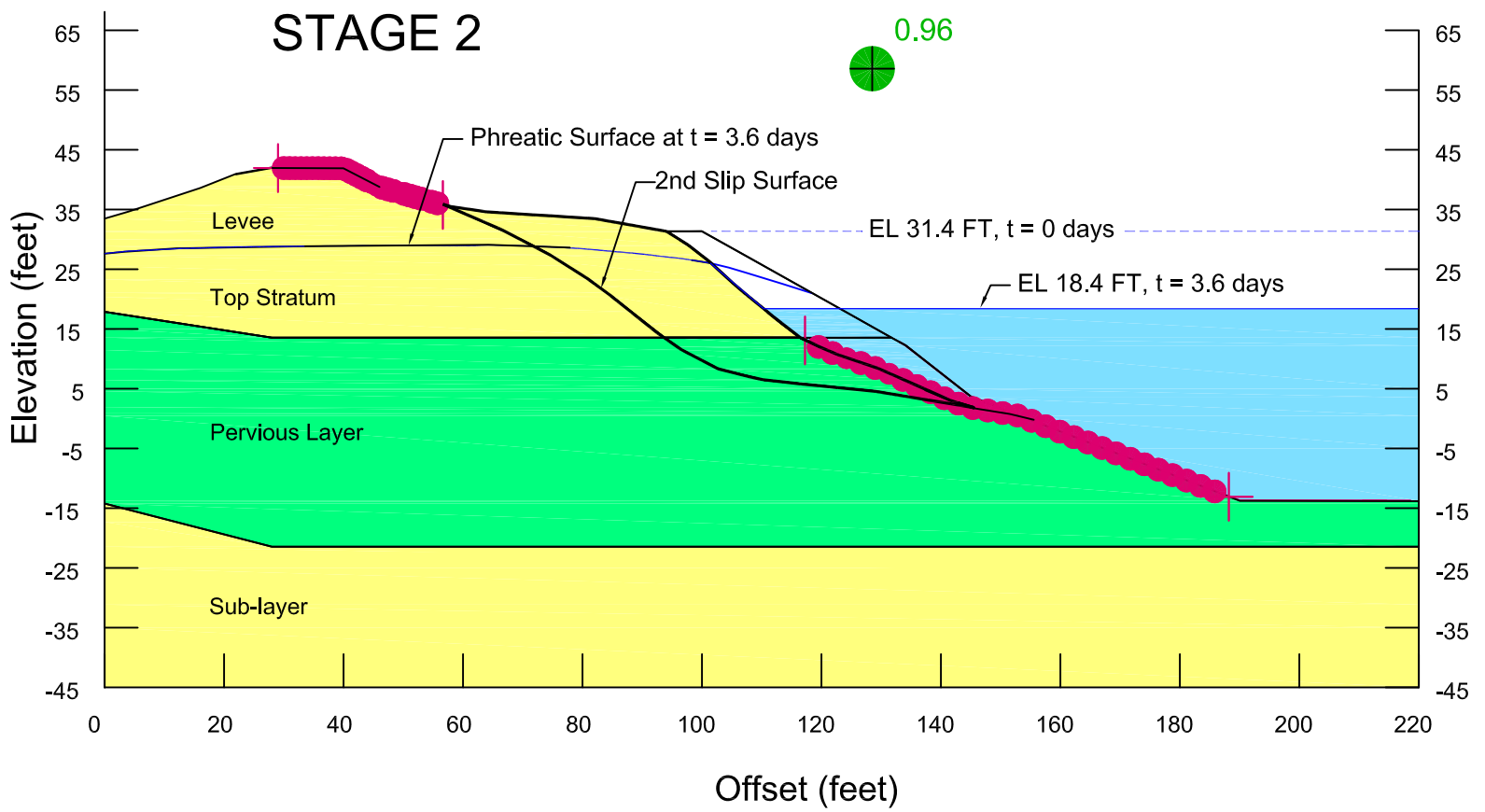
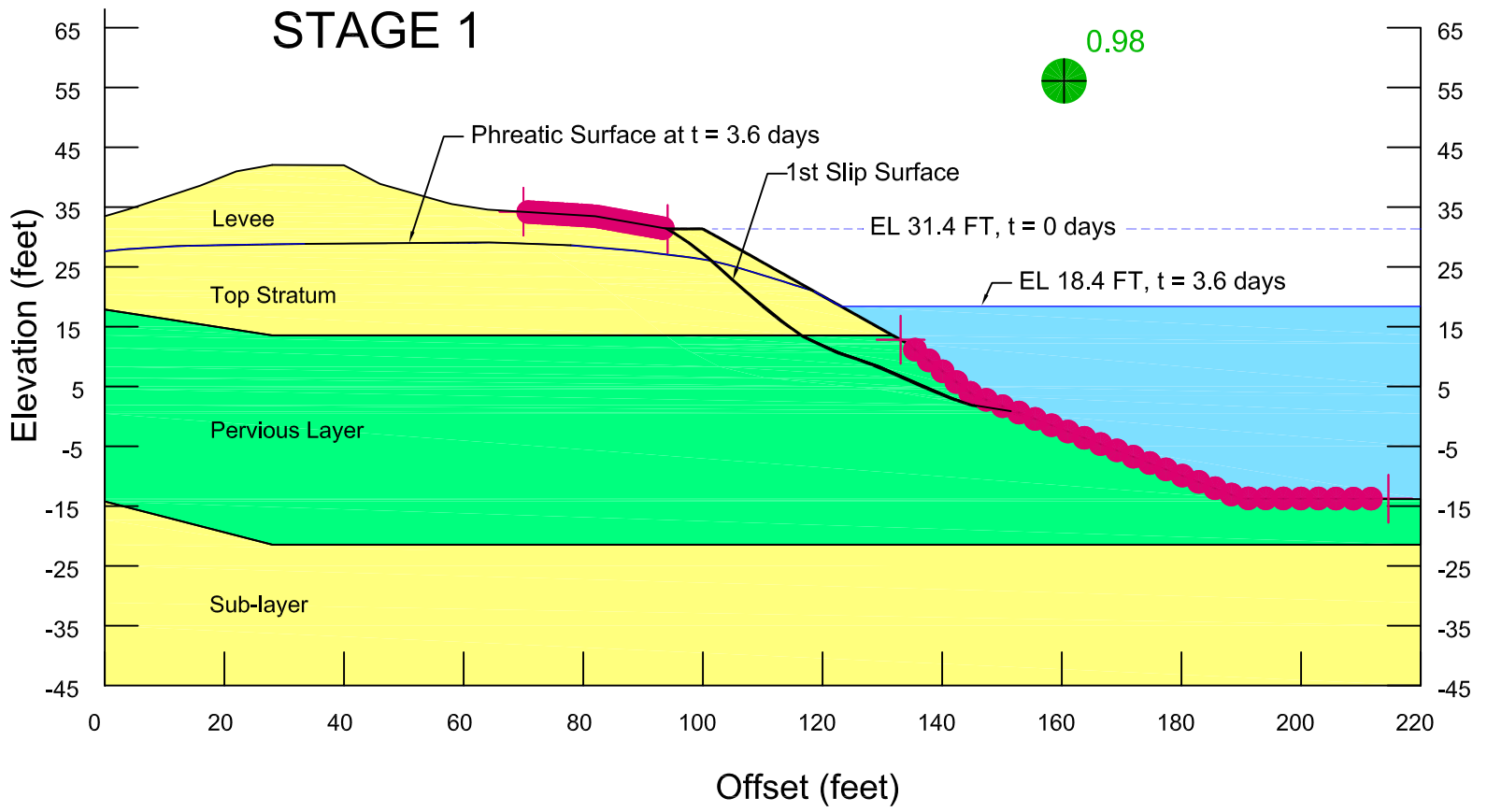

SOIL PARAMETERS	
LV-OB-SUB-Base	Multiple Trial: 108 pcf
Pervious-base	Multiple Trial: 120 pcf
	Multiple Trial: 35°
	Multiple Trial: 31°
	Multiple Trial: 0 psf
	Multiple Trial: 0 psf

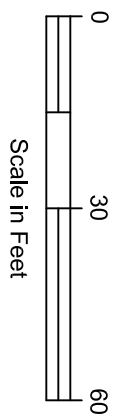

Skagit County Levee General Investigation Skagit County, Washington	SEQUENTIAL FAILURE SCENARIO RIVER SECTION DD17-1L
January 2011 SHANNON & WILSON, INC. Geotechnical and Environmental Consultants	21-1-21199-003 FIG. 21

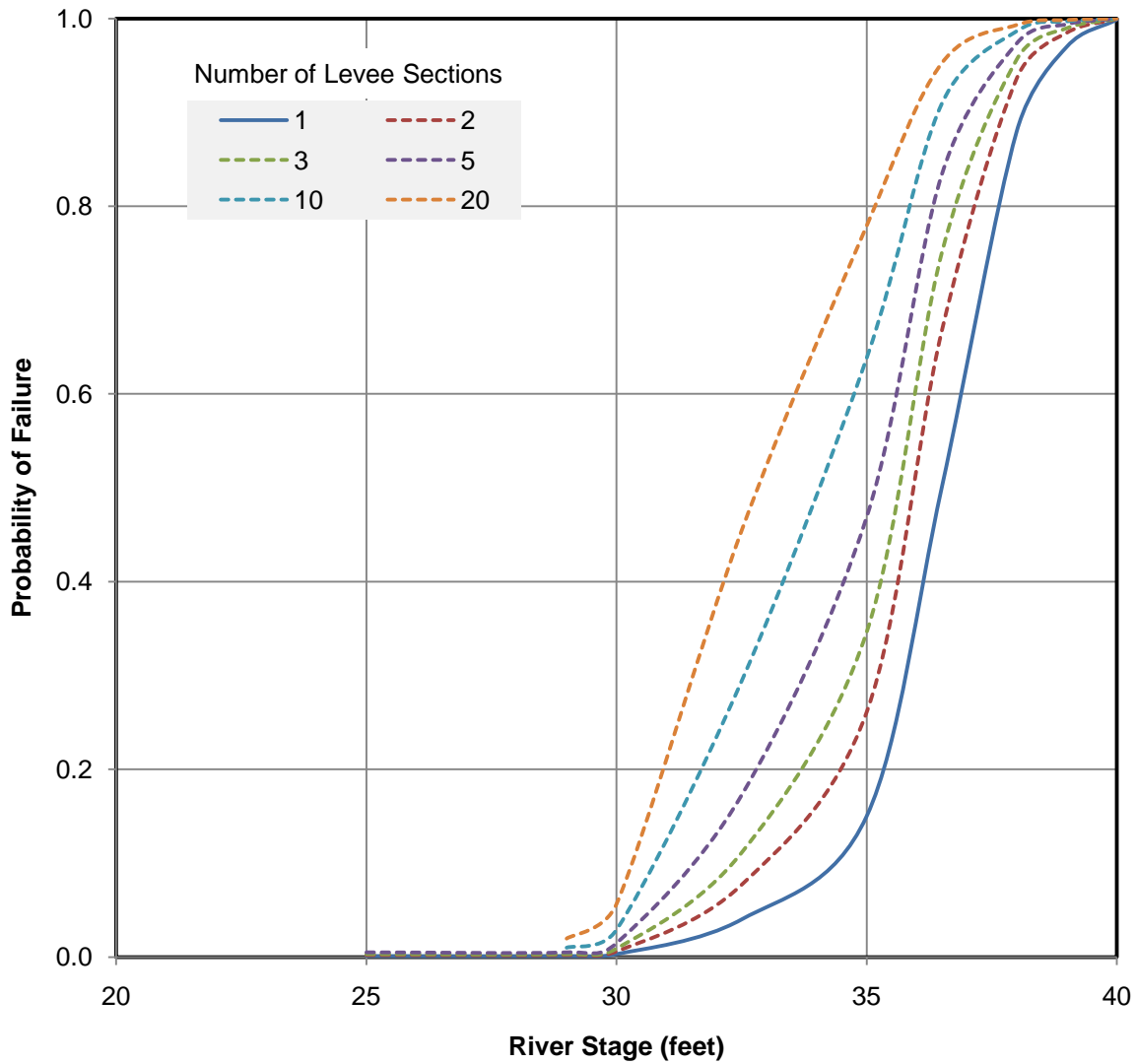

Skagit River Levee General Investigation
 Levee Risk and Reliability Analysis
 Skagit County, Washington

**LENGTH EFFECT ON CONDITIONAL
 PROBABILITY OF LEVEE FAILURE**

January 2011

21-1-21199-003

SHANNON & WILSON, INC.
 Geotechnical and Environmental Consultants

FIG. 22

Conditional Probability of Failure Analysis DD1-1R

Project	NWS Skagit River GI
Feature	Analysis Section DD1-1R
Date	5/6/2010
Computed by	MMY/OTH/HLE

River Stage (feet)		13.1	21.7	30.2	34.5	36.8	37.8	38.8
Underseepage	p_f	0.00	0.00	0.00	0.00	0.29	0.65	1.00
	p_{nf}	1.00	1.00	1.00	1.00	0.71	0.35	0.00
Drawdown	p_f				0.00			0.00
	p_{nf}				1.00			1.00
Landside Static Stability	p_f		0.00	0.00	0.00	0.00		0.00
	p_{nf}		1.00	1.00	1.00	1.00		1.00
Riverside Static Stability	p_f	0.00	0.00	0.00	0.00	0.00		0.00
	p_{nf}	1.00	1.00	1.00	1.00	1.00		1.00
Landside Seismic Stability	p_f	0.00	0.00	0.00	0.01	0.01	0.01	0.01
	p_{nf}	1.00	1.00	1.00	0.99	0.99	0.99	0.99
Riverside Seismic Stability	p_f	0.01	0.01	0.01	0.01	0.00	0.00	0.01
	p_{nf}	0.99	0.99	0.99	0.99	1.00	1.00	0.99
Judgement	p_f	0.00	0.00	0.00	0.00	0.00	0.20	1.00
	p_{nf}	1.00	1.00	1.00	1.00	1.00	0.80	0.00
Combined	p_f	0.01	0.01	0.01	0.01	0.30	0.72	1.00
	p_{nf}	0.99	0.99	0.99	0.99	0.70	0.28	0.00

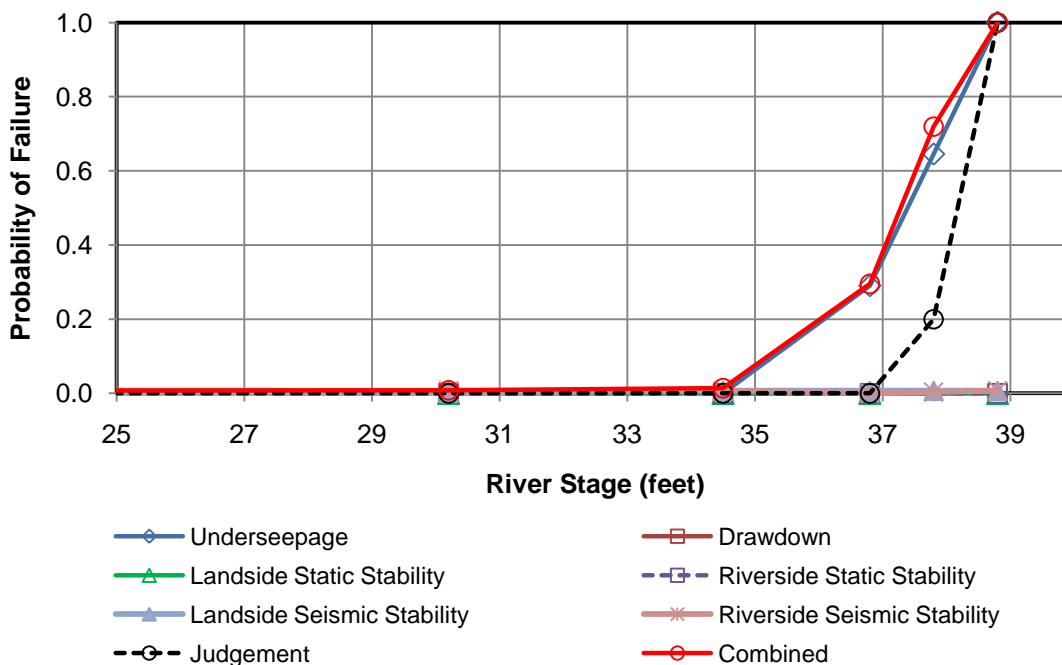

Skagit River Levee General Investigation
Levee Risk and Reliability Analysis
Skagit County, Washington

FRAGILITY CURVE AND TABLE SECTION DD1-1R

January 2011

21-1-21199-003

SHANNON & WILSON, INC.
Geotechnical and Environmental Consultants

FIG. 23

Conditional Probability of Failure Analysis

Project	NWS Skagit River GI
Feature	Analysis Section DD1-2R
Date	5/10/2010
Computed by	MMY

River Stage (feet)		4.4	11.2	14.6	15.8	18.0	23.8	24.8
Underseepage	p_f	0.000	0.000	0.000	0.800	1.000	1.000	1.000
	p_{nf}	1.000	1.000	1.000	0.200	0.000	0.000	0.000
Drawdown	p_f							0.000
	p_{nf}							1.000
Landside Static Stability	p_f	0.000	0.000	0.000	0.202	1.000	0.997	0.997
	p_{nf}	1.000	1.000	1.000	0.798	0.000	0.003	0.003
Riverside Static Stability	p_f	0.000	0.000	0.000		0.000		0.000
	p_{nf}	1.000	1.000	1.000		1.000		1.000
Landside Seismic Stability	p_f	0.006	0.006	0.007	0.007	0.007	0.007	0.007
	p_{nf}	0.994	0.994	0.993	0.993	0.993	0.993	0.993
Riverside Seismic Stability	p_f	0.003	0.006	0.006		0.006	0.006	0.006
	p_{nf}	0.997	0.994	0.994		0.994	0.994	0.994
Judgement	p_f	0.000	0.000	0.000	0.000	0.000	0.200	1.000
	p_{nf}	1.000	1.000	1.000	1.000	0.200	0.800	0.000
Combined	p_f	0.009	0.012	0.013	0.841	1.000	1.000	1.000
	p_{nf}	0.991	0.988	0.987	0.159	0.000	0.000	0.000

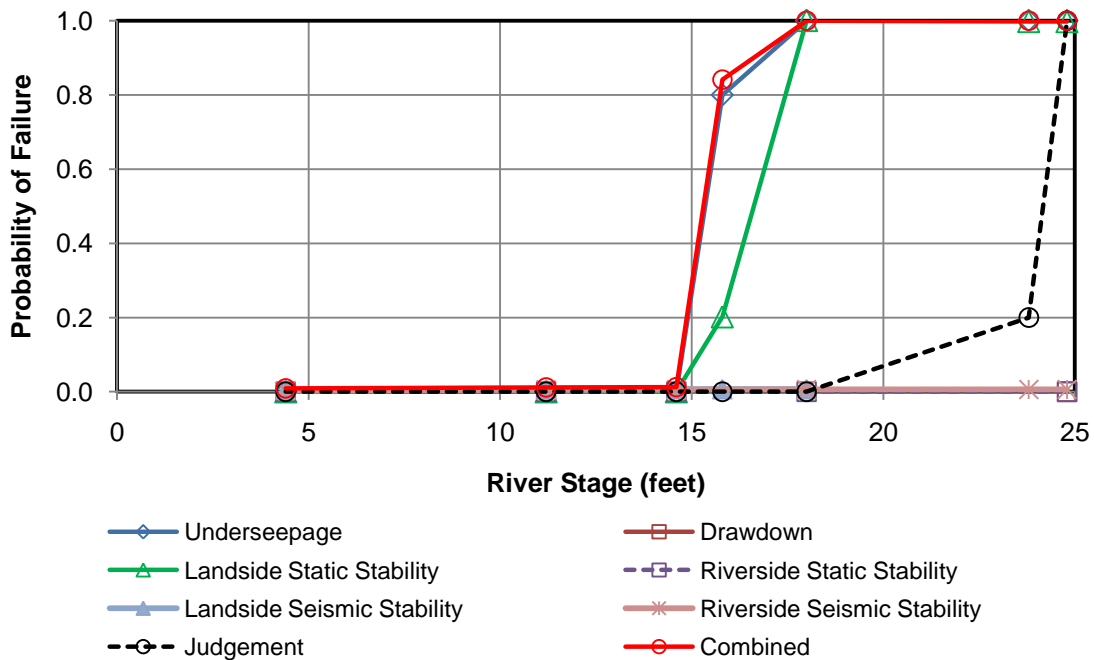

Skagit River Levee General Investigation
Levee Risk and Reliability Analysis
Skagit County, Washington

FRAGILITY CURVE AND TABLE SECTION DD1-2R

January 2011

21-1-21199-003

SHANNON & WILSON, INC.
Geotechnical and Environmental Consultants

FIG. 24

Conditional Probability of Failure Analysis

Project	NWS Skagit River GI
Feature	Analysis Section DD3-1L
Date	5/10/2010
Computed by	MMY

River Stage (feet)		10.5	16.5	22.5	26.2	27.2	28.5
Underseepage	P_f			0.00			0.00
	P_{nf}			1.00			1.00
Drawdown	P_f						0.00
	P_{nf}						1.00
Landside Static Stability	P_f	0.01	0.00	0.00	0.00	0.19	0.93
	P_{nf}	0.99	1.00	1.00	1.00	0.81	0.07
Riverside Static Stability	P_f	0.00	0.00	0.00			0.00
	P_{nf}	1.00	1.00	1.00			1.00
Landside Seismic Stability	P_f	0.00	0.00	0.00			0.01
	P_{nf}	1.00	1.00	1.00			0.99
Riverside Seismic Stability	P_f	0.00	0.00	0.00			0.00
	P_{nf}	1.00	1.00	1.00			1.00
Judgement	P_f	0.00	0.00	0.00	0.00	0.20	1.00
	P_{nf}	1.00	1.00	1.00	1.00	0.80	0.00
Combined	P_f	0.01	0.00	0.00	0.00	0.35	1.00
	P_{nf}	0.99	1.00	1.00	1.00	0.65	0.00

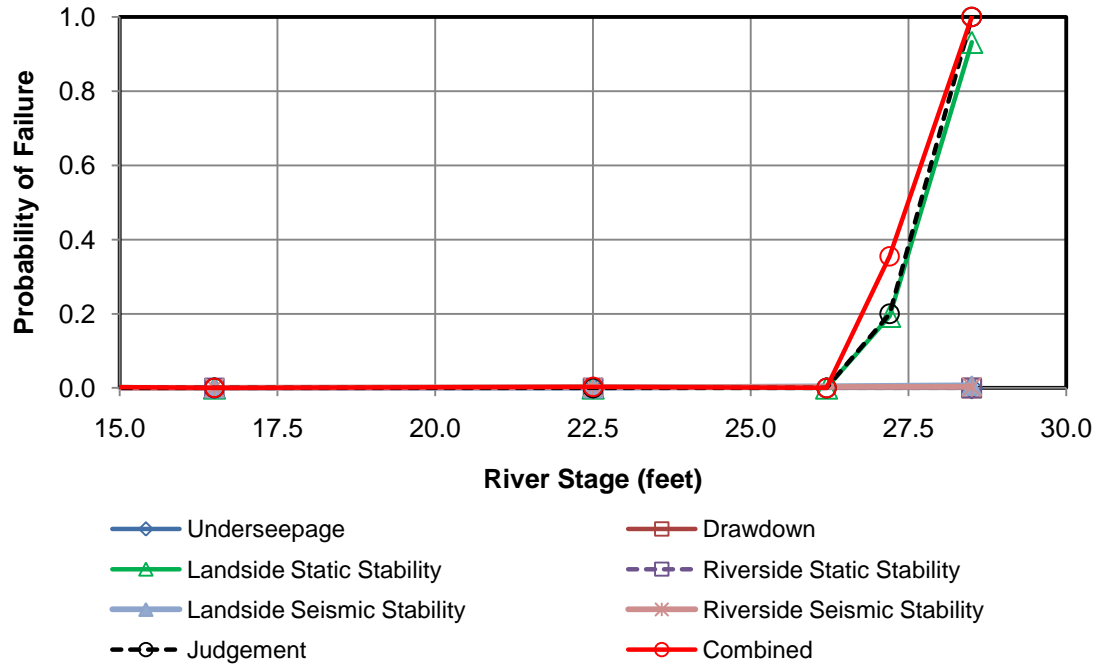

Skagit River Levee General Investigation
Levee Risk and Reliability Analysis
Skagit County, Washington

FRAGILITY CURVE AND TABLE SECTION DD3-1L

January 2011

21-1-21199-003

SHANNON & WILSON, INC.
Geotechnical and Environmental Consultants

FIG. 25

Conditional Probability of Failure Analysis

Project	NWS Skagit River GI
Feature	Analysis Section D17-1L
Date	5/10/2010
Computed by	MMY

River Stage (feet)		20.6	28.3	35.8	40.1	42.2	43.2
Underseepage	p_f			0.000	0.281	0.768	1.000
	p_{nf}			1.000	0.719	0.232	0.000
Drawdown	p_f						0.000
	p_{nf}						1.000
Landside Static Stability	p_f		0.000	0.000	0.013	0.681	1.000
	p_{nf}		1.000	1.000	0.987	0.319	0.000
Riverside Static Stability	p_f	0.000	0.000	0.000	0.000	0.000	0.000
	p_{nf}	1.000	1.000	1.000	1.000	1.000	1.000
Landside Seismic Stability	p_f		0.000	0.000	0.007	0.007	0.007
	p_{nf}		1.000	1.000	0.993	0.993	0.993
Riverside Seismic Stability	p_f	0.007	0.007	0.007	0.007	0.007	0.007
	p_{nf}	0.993	0.993	0.993	0.993	0.993	0.993
Judgement	p_f	0.000	0.000	0.000	0.000	0.200	1.000
	p_{nf}	1.000	1.000	1.000	1.000	0.800	0.000
Combined	p_f	0.007	0.007	0.007	0.299	0.942	1.000
	p_{nf}	0.993	0.993	0.993	0.701	0.058	0.000

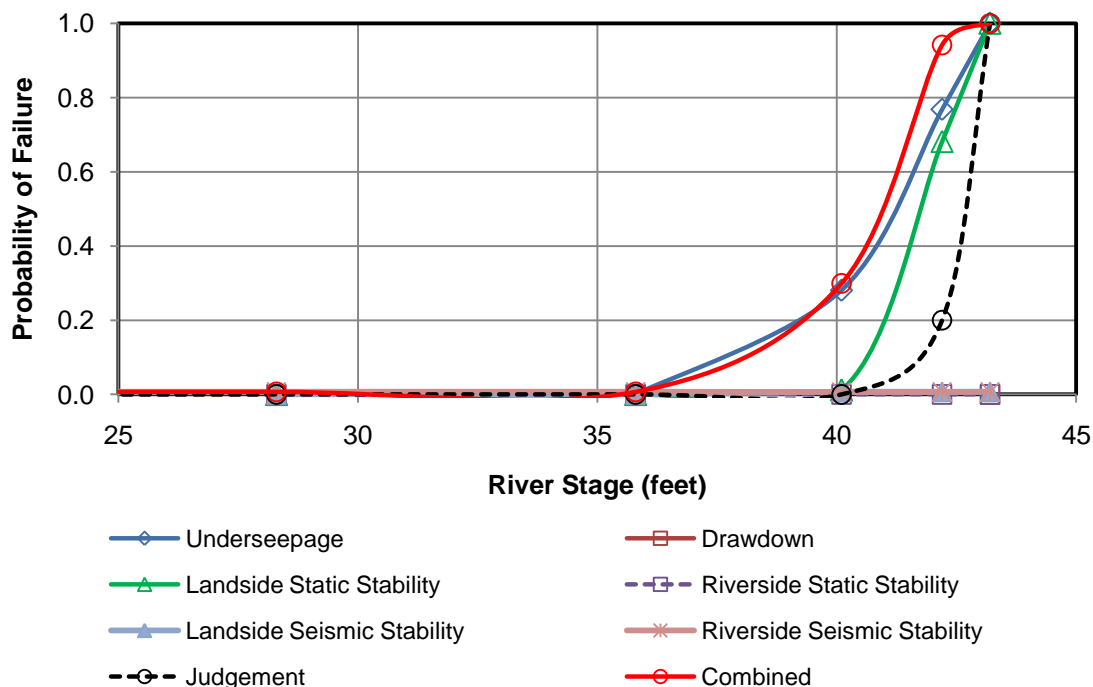

Skagit River Levee General Investigation
Levee Risk and Reliability Analysis
Skagit County, Washington

FRAGILITY CURVE AND TABLE SECTION DD17-1L

January 2011

21-1-21199-003

SHANNON & WILSON, INC.
Geotechnical and Environmental Consultants

FIG. 26

Conditional Probability of Failure Analysis

Project	NWS Skagit River GI
Feature	Analysis Section DD17-2L
Date	5/10/10
Computed by	MMY

River Stage (feet)		13.1	23.3	31.8	36.0	38.3	39.3
Underseepage	p_f	0.00	0.00	0.00	0.00		0.00
	p_{nf}	1.00	1.00	1.00	1.00		1.00
Drawdown	p_f						0.00
	p_{nf}						1.00
Landside Static Stability	p_f		0.00	0.00	0.00	0.42	0.60
	p_{nf}		1.00	1.00	1.00	0.58	0.40
Riverside Static Stability	p_f	0.00	0.00	0.00			0.00
	p_{nf}	1.00	1.00	1.00			1.00
Landside Seismic Stability	p_f		0.00	0.00	0.01	0.01	0.01
	p_{nf}		1.00	1.00	0.99	0.99	0.99
Riverside Seismic Stability	p_f	0.00	0.01	0.01			0.01
	p_{nf}	1.00	0.99	0.99			0.99
Judgement	p_f	0.00	0.00	0.00	0.00	0.20	1.00
	p_{nf}	1.00	1.00	1.00	1.00	0.80	0.00
Combined	p_f	0.00	0.01	0.01	0.01	0.54	1.00
	p_{nf}	1.00	0.99	0.99	0.99	0.46	0.00

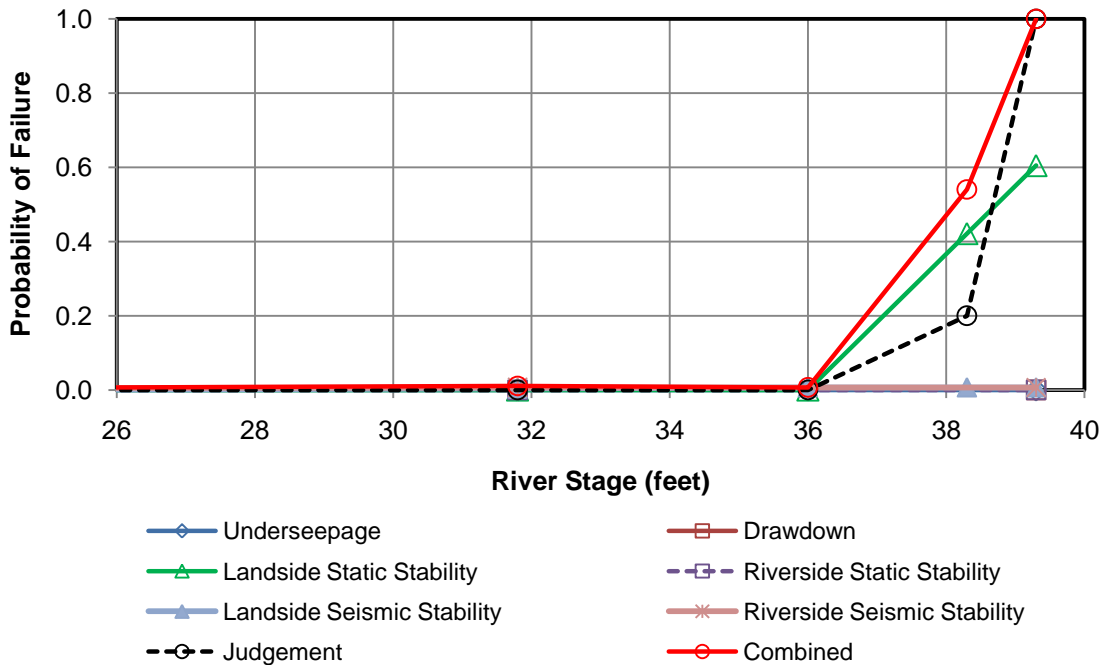

Skagit River Levee General Investigation
Levee Risk and Reliability Analysis
Skagit County, Washington

**FRAGILITY CURVE AND TABLE
SECTION DD17-2L**

January 2011 21-1-21199-003

SHANNON & WILSON, INC.
Geotechnical and Environmental Consultants **FIG. 27**

Conditional Probability of Failure Analysis

Project	NWS Skagit River GI
Feature	Analysis Section DD17-3L
Date	5/10/2010
Computed by	MMY

River Stage (feet)		13.8	23.1	31.1	35.3	38.1	39.1
Underseepage	p_f			0.00	0.00	0.00	0.00
	p_{nf}			1.00	1.00	1.00	1.00
Drawdown	p_f						0.00
	p_{nf}						1.00
Landside Static Stability	p_f			0.00	0.16	0.78	1.00
	p_{nf}			1.00	0.84	0.22	0.00
Riverside Static Stability	p_f	0.00	0.00	0.00		0.00	0.00
	p_{nf}	1.00	1.00	1.00		1.00	1.00
Landside Seismic Stability	p_f	0.01	0.01	0.01		0.01	0.01
	p_{nf}	0.99	0.99	0.99		0.99	0.99
Riverside Seismic Stability	p_f	0.00	0.01	0.01		0.01	0.01
	p_{nf}	1.00	0.99	0.99		0.99	0.99
Judgement	p_f	0.00	0.00	0.00	0.00	0.20	1.00
	p_{nf}	1.00	1.00	1.00	1.00	0.80	0.00
Combined	p_f	0.01	0.01	0.01	0.16	0.83	1.00
	p_{nf}	0.99	0.99	0.99	0.84	0.17	0.00

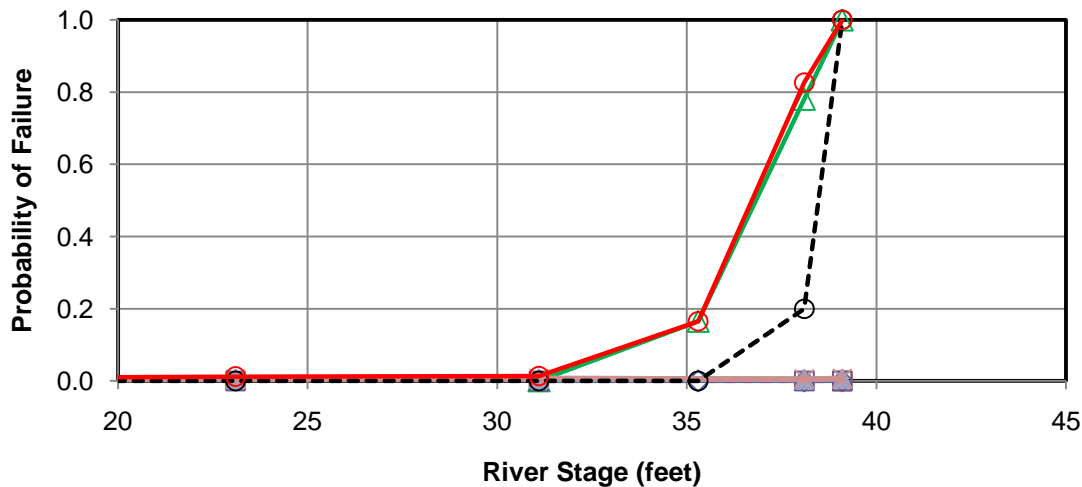

- ◆ Underseepage
- Drawdown
- ▲ Landside Static Stability
- Riverside Static Stability
- ▲ Landside Seismic Stability
- ✱ Riverside Seismic Stability
- Judgement
- Combined

Skagit River Levee General Investigation
Levee Risk and Reliability Analysis
Skagit County, Washington

FRAGILITY CURVE AND TABLE SECTION DD17-3L

January 2011

21-1-21199-003

SHANNON & WILSON, INC.
Geotechnical and Environmental Consultants

FIG. 28

Conditional Probability of Failure Analysis

Project	NWS Skagit River GI
Feature	Analysis Sectin DD22-1R
Date	5/10/2010
Computed by	MMY

River Stage (feet)		5.1	12.0	18.0	23.0	24.0
Underseepage	P_f	0.00	0.00	0.00	0.00	0.00
	P_{nf}	1.00	1.00	1.00	1.00	1.00
Drawdown	P_f					0.00
	P_{nf}					1.00
Landside Static Stability	P_f		0.00	0.00	0.00	0.00
	P_{nf}		1.00	1.00	1.00	1.00
Riverside Static Stability	P_f	0.00	0.00	0.00	0.00	0.00
	P_{nf}	1.00	1.00	1.00	1.00	1.00
Landside Seismic Stability	P_f		0.00	0.00	0.01	0.01
	P_{nf}		1.00	1.00	0.99	0.99
Riverside Seismic Stability	P_f	0.00	0.00	0.00	0.00	0.00
	P_{nf}	1.00	1.00	1.00	1.00	1.00
Judgement	P_f	0.00	0.00	0.00	0.20	1.00
	P_{nf}	1.00	1.00	1.00	0.80	0.00
Combined	P_f	0.00	0.00	0.00	0.21	1.00
	P_{nf}	1.00	1.00	1.00	0.79	0.00

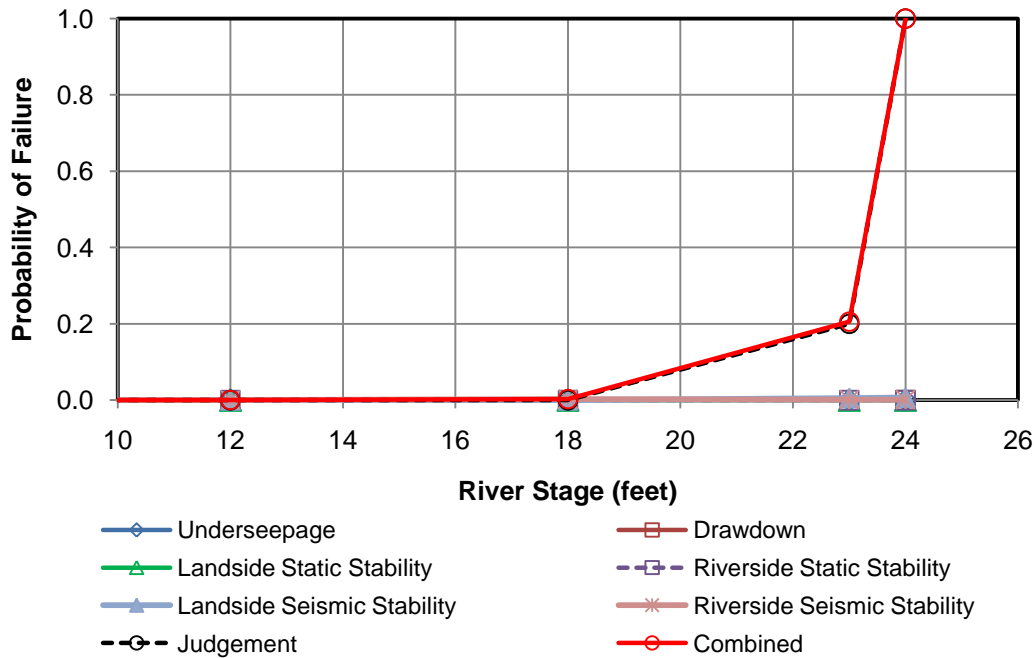

Skagit River Levee General Investigation
Levee Risk and Reliability Analysis
Skagit County, Washington

**FRAGILITY CURVE AND TABLE
SECTION DD22-1R**

January 2011 21-1-21199-003

SHANNON & WILSON, INC. Geotechnical and Environmental Consultants	FIG. 29
---	----------------

Conditional Probability of Failure Analysis

Project	NWS Skagit River GI
Feature	Analysis Section DD22-2L
Date	5/10/2010
Computed by	MMY

River Stage (feet)		7.4	11.5	16.3	18.5	20.0	21.0
Underseepage	P_f		0.00	0.00	0.00	0.00	0.00
	P_{nf}		1.00	1.00	1.00	1.00	1.00
Drawdown	P_f						0.00
	P_{nf}						1.00
Landside Static Stability	P_f		0.03	0.02	0.57	0.83	1.00
	P_{nf}		0.97	0.98	0.43	0.17	0.00
Riverside Static Stability	P_f	0.00	0.00	0.00		0.00	0.00
	P_{nf}	1.00	1.00	1.00		1.00	1.00
Landside Seismic Stability	P_f		0.01	0.01		0.00	0.01
	P_{nf}		0.99	0.99		1.00	0.99
Riverside Seismic Stability	P_f	0.01	0.01	0.01		0.00	0.01
	P_{nf}	0.99	0.99	0.99		1.00	0.99
Judgement	P_f	0.00	0.00	0.00	0.00	0.20	1.00
	P_{nf}	1.00	1.00	1.00	1.00	0.80	0.00
Combined	P_f	0.01	0.05	0.04	0.57	0.86	1.00
	P_{nf}	0.99	0.95	0.96	0.43	0.14	0.00

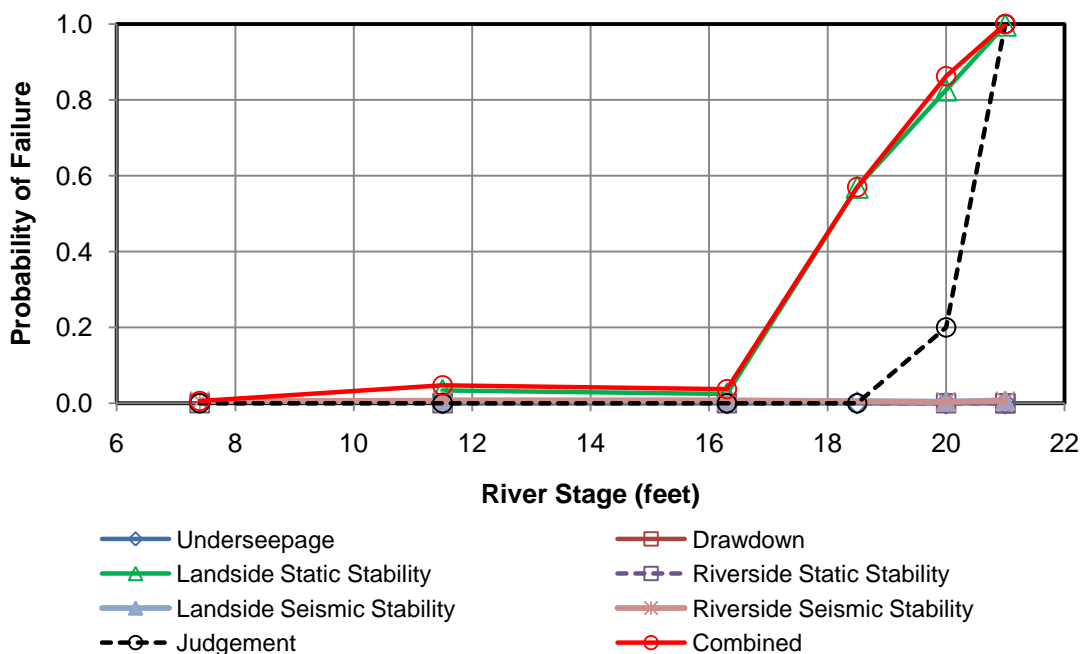

Skagit River Levee General Investigation
Levee Risk and Reliability Analysis
Skagit County, Washington

**FRAGILITY CURVE AND TABLE
SECTION DD22-2L**

January 2011 21-1-21199-003

SHANNON & WILSON, INC. Geotechnical and Environmental Consultants	FIG. 30
---	----------------

APPENDIX A
BORING LOGS

Shannon & Wilson, Inc. (S&W), uses a soil classification system modified from the Unified Soil Classification System (USCS). Elements of the USCS and other definitions are provided on this and the following page. Soil descriptions are based on visual-manual procedures (ASTM D 2488-93) unless otherwise noted.

S&W CLASSIFICATION OF SOIL CONSTITUENTS

- MAJOR constituents compose more than 50 percent, by weight, of the soil. Major constituents are capitalized (i.e., SAND).
- Minor constituents compose 12 to 50 percent of the soil and precede the major constituents (i.e., silty SAND). Minor constituents preceded by "slightly" compose 5 to 12 percent of the soil (i.e., slightly silty SAND).
- Trace constituents compose 0 to 5 percent of the soil (i.e., slightly silty SAND, trace of gravel).

MOISTURE CONTENT DEFINITIONS

Dry	Absence of moisture, dusty, dry to the touch
Moist	Damp but no visible water
Wet	Visible free water, from below water table

ABBREVIATIONS

ATD	At Time of Drilling
Elev.	Elevation
ft	feet
FeO	Iron Oxide
MgO	Magnesium Oxide
HSA	Hollow Stem Auger
ID	Inside Diameter
in	inches
lbs	pounds
Mon.	Monument cover
N	Blows for last two 6-inch increments
NA	Not applicable or not available
NP	Non plastic
OD	Outside diameter
OVA	Organic vapor analyzer
PID	Photo-ionization detector
ppm	parts per million
PVC	Polyvinyl Chloride
SS	Split spoon sampler
SPT	Standard penetration test
USC	Unified soil classification
WOH	Weight of hammer
WOR	Weight of drill rods
WLI	Water level indicator

GRAIN SIZE DEFINITION











DESCRIPTION	SIEVE NUMBER AND/OR SIZE
FINES	< #200 (0.08 mm)
SAND*	- Fine - Medium - Coarse
	#200 to #40 (0.08 to 0.4 mm) #40 to #10 (0.4 to 2 mm) #10 to #4 (2 to 5 mm)
GRAVEL*	- Fine - Coarse
	#4 to 3/4 inch (5 to 19 mm) 3/4 to 3 inches (19 to 76 mm)
COBBLES	3 to 12 inches (76 to 305 mm)
BOULDERS	> 12 inches (305 mm)

* Unless otherwise noted, sand and gravel, when present, range from fine to coarse in grain size.

RELATIVE DENSITY / CONSISTENCY

COARSE-GRAINED SOILS		FINE-GRAINED SOILS	
N, SPT, BLOWS/FT.	RELATIVE DENSITY	N, SPT, BLOWS/FT.	RELATIVE CONSISTENCY
0 - 4	Very loose	Under 2	Very soft
4 - 10	Loose	2 - 4	Soft
10 - 30	Medium dense	4 - 8	Medium stiff
30 - 50	Dense	8 - 15	Stiff
Over 50	Very dense	15 - 30	Very stiff
		Over 30	Hard

WELL AND OTHER SYMBOLS

	Bent. Cement Grout		Surface Cement Seal
	Bentonite Grout		Asphalt or Cap
	Bentonite Chips		Slough
	Silica Sand		Bedrock
	PVC Screen		
	Vibrating Wire		

Skagit River Levee General Investigation
Skagit County, Washington

SOIL CLASSIFICATION AND LOG KEY















June 2010

21-1-21199-002

SHANNON & WILSON, INC.
Geotechnical and Environmental Consultants

FIG. A-1
Sheet 1 of 2

UNIFIED SOIL CLASSIFICATION SYSTEM (USCS)
(From USACE Tech Memo 3-357)

MAJOR DIVISIONS			GROUP/GRAPHIC SYMBOL	TYPICAL DESCRIPTION	
COARSE-GRAINED SOILS (more than 50% retained on No. 200 sieve)	Gravels (more than 50% of coarse fraction retained on No. 4 sieve)	Clean Gravels (less than 5% fines)	GW		Well-graded gravels, gravels, gravel/sand mixtures, little or no fines.
		Gravels with Fines (more than 12% fines)	GP		Poorly graded gravels, gravel-sand mixtures, little or no fines
			GM		Silty gravels, gravel-sand-silt mixtures
			GC		Clayey gravels, gravel-sand-clay mixtures
	Sands (50% or more of coarse fraction passes the No. 4 sieve)	Clean Sands (less than 5% fines)	SW		Well-graded sands, gravelly sands, little or no fines
		Sands with Fines (more than 12% fines)	SP		Poorly graded sand, gravelly sands, little or no fines
			SM		Silty sands, sand-silt mixtures
			SC		Clayey sands, sand-clay mixtures
FINE-GRAINED SOILS (50% or more passes the No. 200 sieve)	Sils and Clays (liquid limit less than 50)	Inorganic	ML		Inorganic silts of low to medium plasticity, rock flour, sandy silts, gravelly silts, or clayey silts with slight plasticity
			CL		Inorganic clays of low to medium plasticity, gravelly clays, sandy clays, silty clays, lean clays
		Organic	OL		Organic silts and organic silty clays of low plasticity
	Sils and Clays (liquid limit 50 or more)	Inorganic	MH		Inorganic silts, micaceous or diatomaceous fine sands or silty soils, elastic silt
			CH		Inorganic clays of medium to high plasticity, sandy fat clay, or gravelly fat clay
		Organic	OH		Organic clays of medium to high plasticity, organic silts
HIGHLY-ORGANIC SOILS	Primarily organic matter, dark in color, and organic odor	PT		Peat, humus, swamp soils with high organic content (see ASTM D 4427)	

NOTE: No. 4 size = 5 mm; No. 200 size = 0.075 mm

NOTES

- Dual symbols (symbols separated by a hyphen, i.e., SP-SM, slightly silty fine SAND) are used for soils with between 5% and 12% fines or when the liquid limit and plasticity index values plot in the CL-ML area of the plasticity chart.
- Borderline symbols (symbols separated by a slash, i.e., CL/ML, silty CLAY/clayey SILT; GW/SW, sandy GRAVEL/gravelly SAND) indicate that the soil may fall into one of two possible basic groups.

Skagit River Levee General Investigation
Skagit County, Washington

**SOIL CLASSIFICATION
AND LOG KEY**

June 2010

21-1-21199-002

SHANNON & WILSON, INC.
Geotechnical and Environmental Consultants

FIG. A-1
Sheet 2 of 2

Total Depth: 41.5 ft.	Northing: ~ 525,847 ft.	Drilling Method: Mud Rotary	Hole Diam.: 5 in.
Top Elevation: ~	Easting: ~ 1,268,352 ft.	Drilling Company: Holocene Drilling	Rod Diam.: NWJ
Vert. Datum: ~	Station: ~	Drill Rig Equipment: B-61 Mobile Truck	Hammer Type: Automatic
Horiz. Datum: NAD83	Offset: ~	Other Comments:	

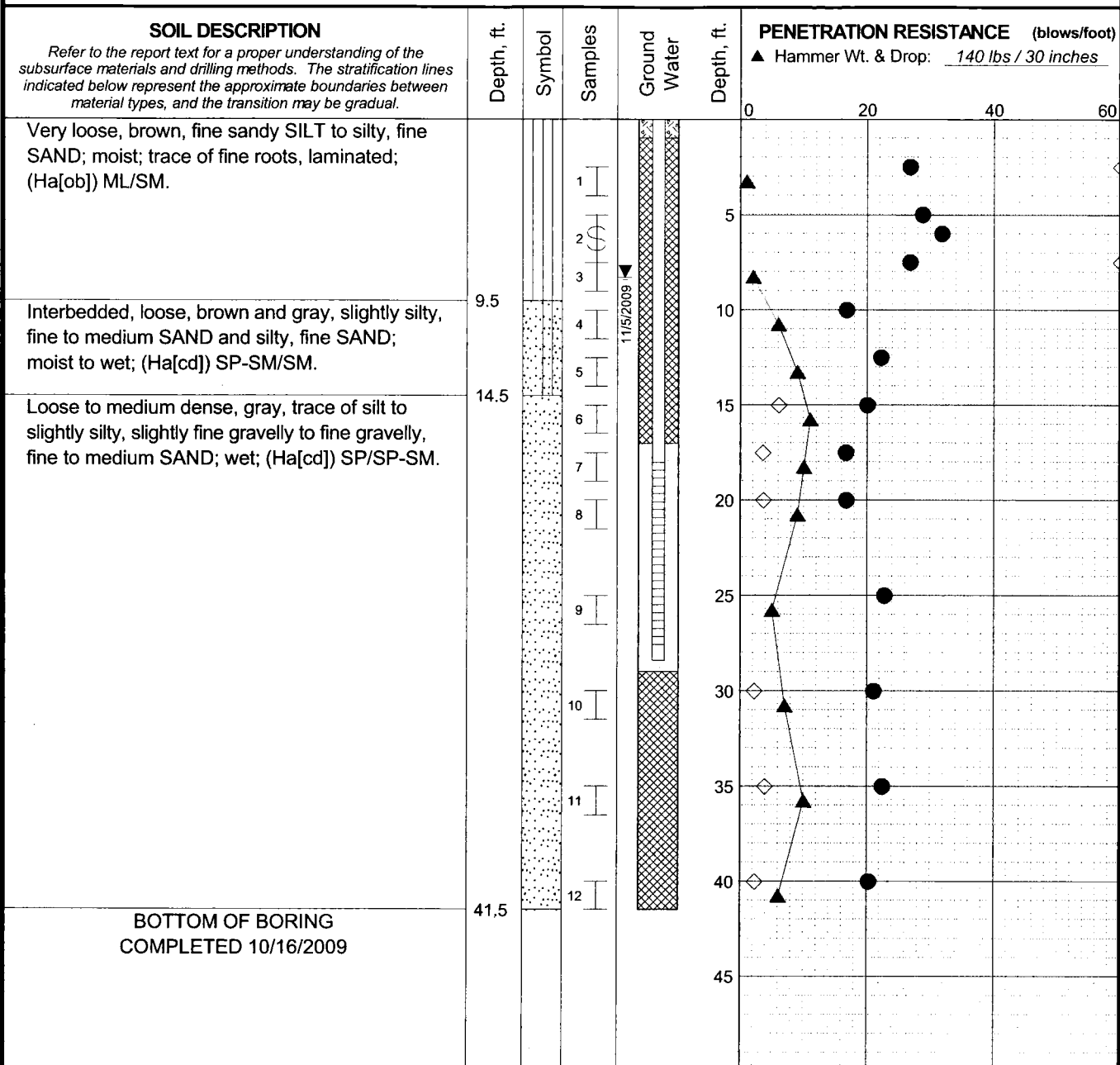

Log: EVP Rev: JKN Typ: CLP
 MASTER LOG E 21-21199.GPJ SHAN WIL GDT 6/1/10

- LEGEND**
- * Sample Not Recovered
 - Standard Penetration Test
 - 3" O.D. Thin-Walled Tube
 - Piezometer Screen and Sand Filter
 - Bentonite-Cement Grout
 - Bentonite Chips/Pellets
 - Bentonite Grout
 - ▼ Ground Water Level in Well
 - ◇ % Fines (<0.075mm)
 - % Water Content

- NOTES**
- Refer to KEY for explanation of symbols, codes, abbreviations and definitions.
 - The stratification lines represent the approximate boundaries between soil types, and the transition may be gradual.
 - The discussion in the text of this report is necessary for a proper understanding of the nature of the subsurface materials.
 - Groundwater level, if indicated above, is for the date specified and may vary.
 - USCS designation is based on visual-manual classification and selected lab testing.

Skagit River Levee General Investigation
 Skagit County, Washington

LOG OF BORING DD1-1 Landward

June 2010
21-21199-002

SHANNON & WILSON, INC.
Geotechnical and Environmental Consultants
FIG. A-2

Total Depth: 61.5 ft.	Northing: ~ 525,954 ft.	Drilling Method: Mud Rotary	Hole Diam.: 5 in.
Top Elevation: ~	Easting: ~ 1,268,368 ft.	Drilling Company: Holocene Drilling	Rod Diam.: NWJ
Vert. Datum: ~	Station: ~	Drill Rig Equipment: B-61 Mobile Truck	Hammer Type: Automatic
Horiz. Datum: NAD83	Offset: ~	Other Comments:	

SOIL DESCRIPTION
Refer to the report text for a proper understanding of the subsurface materials and drilling methods. The stratification lines indicated below represent the approximate boundaries between material types, and the transition may be gradual.

Loose to medium dense, brown, fine sandy SILT; moist; trace of organics; (Hf) ML.				
Soft, brown, trace to slightly clayey, trace of fine sand to slightly fine sandy SILT; moist to wet; scattered roots; (Ha[ob]) ML.	17.0			
Loose, gray, silty, fine to medium SAND; wet; scattered silty, fine sand seams, iron-oxide staining; (Ha[ob]) SM.	23.0			
Interbedded, loose, gray-brown, slightly fine sandy to fine sandy SILT, silty, fine SAND, and medium stiff, organic SILT; wet; 1/2-inch silty clay seam and 7-inch-thick wood fragment; (Ha[ob]) ML/SM/OL.	26.5			
Loose to medium dense, gray, trace to slightly fine gravelly, trace to slightly silty SAND; wet; (Ha[cd]) SP-SM/SP.	30.0			

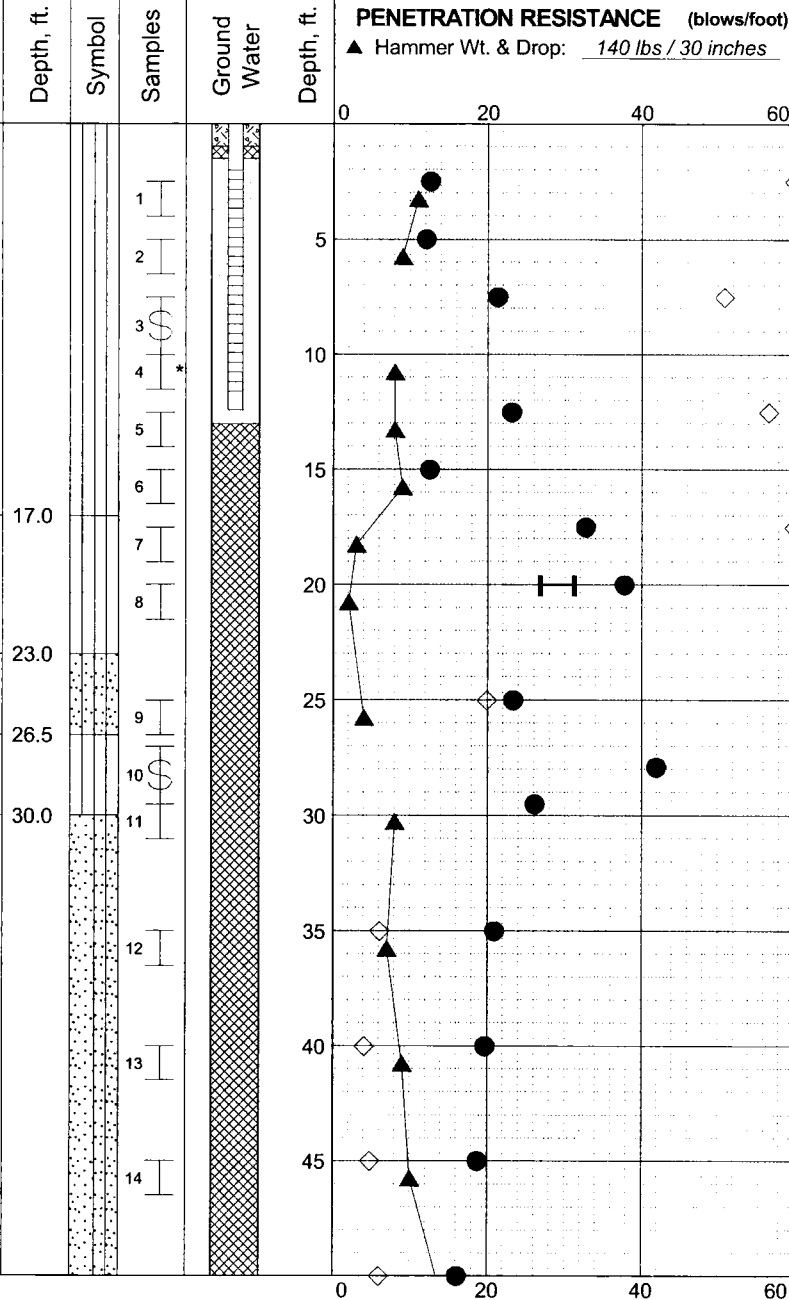

Log: EVP Rev: JKN Typ: CLP MASTER LOG E 21-21199.GPJ SHAN WIL GDT 6/1/10

CONTINUED NEXT SHEET

LEGEND

- | | | | | |
|------------------------|--|-----------------------------------|--|-----------------------|
| * Sample Not Recovered | | Piezometer Screen and Sand Filter | | % Fines (<0.075mm) |
| | | Bentonite-Cement Grout | | % Water Content |
| | | Bentonite Chips/Pellets | | Plastic Limit |
| | | Bentonite Grout | | Liquid Limit |
| | | | | Natural Water Content |

NOTES

- Refer to KEY for explanation of symbols, codes, abbreviations and definitions.
- The stratification lines represent the approximate boundaries between soil types, and the transition may be gradual.
- The discussion in the text of this report is necessary for a proper understanding of the nature of the subsurface materials.
- Groundwater level, if indicated above, is for the date specified and may vary.
- USCS designation is based on visual-manual classification and selected lab testing.

Skagit River Levee General Investigation
Skagit County, Washington

LOG OF BORING DD1-1 Levee

June 2010 21-1-21199-002

SHANNON & WILSON, INC. Geotechnical and Environmental Consultants	FIG. A-3 Sheet 1 of 2
---	---------------------------------

Total Depth: 61.5 ft.	Northing: ~ 525,954 ft.	Drilling Method: Mud Rotary	Hole Diam.: 5 in.
Top Elevation: ~	Easting: ~ 1,268,368 ft.	Drilling Company: Holocene Drilling	Rod Diam.: NWJ
Vert. Datum: ~	Station: ~	Drill Rig Equipment: B-61 Mobile Truck	Hammer Type: Automatic
Horiz. Datum: NAD83	Offset: ~	Other Comments:	

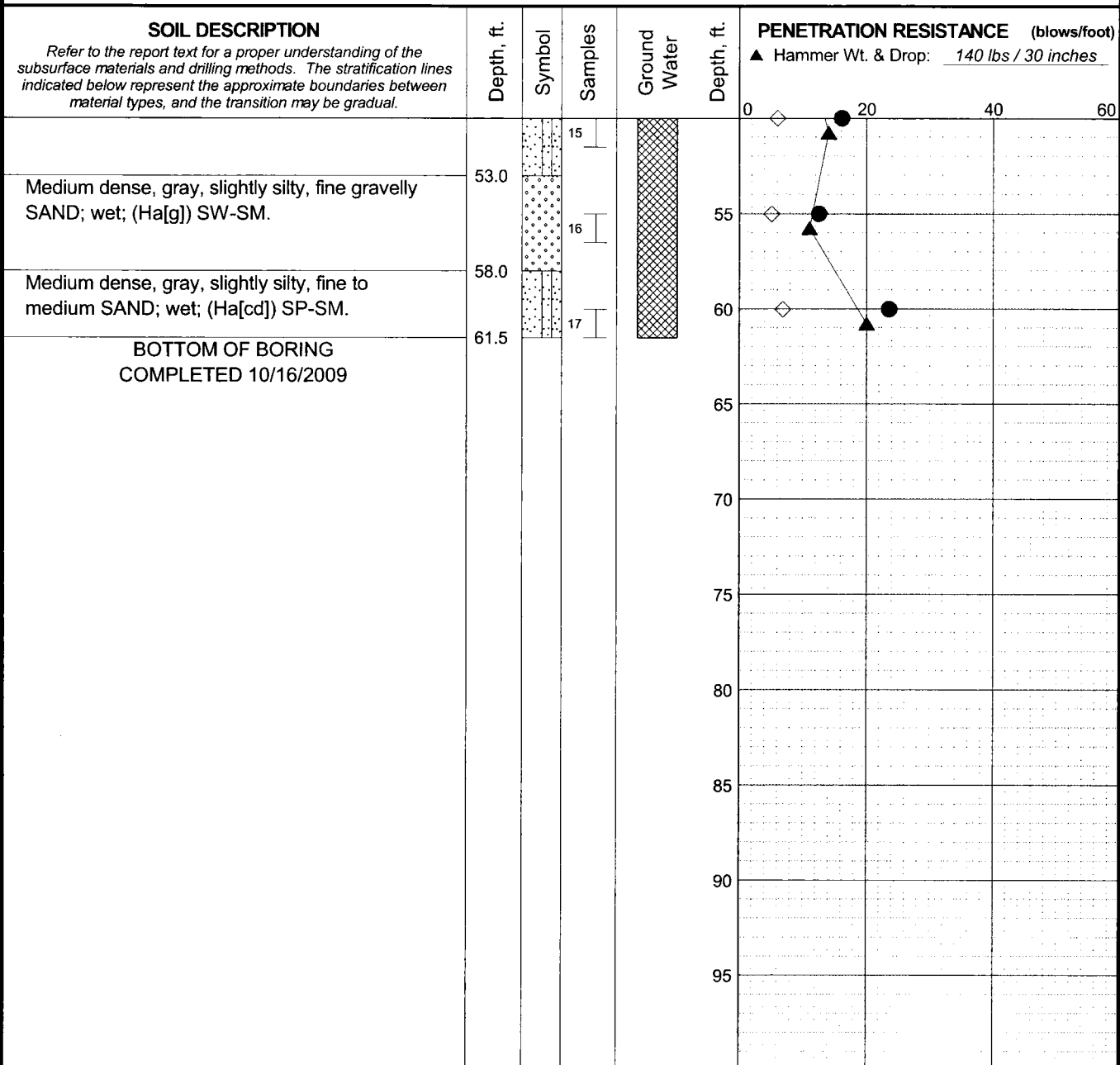

MASTER LOG E 21-21199.GPJ SHAN WIL.GDT 6/1/10
 Log: EYP Rev: JKN Typ: CLP

LEGEND

* Sample Not Recovered	[Symbol]	Piezometer Screen and Sand Filter	◇ % Fines (<0.075mm)
[Symbol] Standard Penetration Test	[Symbol]	Bentonite-Cement Grout	● % Water Content
[Symbol] 3" O.D. Thin-Walled Tube	[Symbol]	Bentonite Chips/Pellets	—●— Liquid Limit
	[Symbol]	Bentonite Grout	—●— Natural Water Content

- NOTES**
- Refer to KEY for explanation of symbols, codes, abbreviations and definitions.
 - The stratification lines represent the approximate boundaries between soil types, and the transition may be gradual.
 - The discussion in the text of this report is necessary for a proper understanding of the nature of the subsurface materials.
 - Groundwater level, if indicated above, is for the date specified and may vary.
 - USCS designation is based on visual-manual classification and selected lab testing.

Skagit River Levee General Investigation
Skagit County, Washington

LOG OF BORING DD1-1 Levee

June 2010 21-21199-002

SHANNON & WILSON, INC. Geotechnical and Environmental Consultants	FIG. A-3 Sheet 2 of 2
---	---------------------------------

Total Depth: 41.5 ft. Northing: ~ 508,726 ft. Drilling Method: Mud Rotary Hole Diam.: 5 in.
 Top Elevation: ~ Easting: ~ 1,263,857 ft. Drilling Company: Holocene Drilling Rod Diam.: NWJ
 Vert. Datum: ~ Station: ~ Drill Rig Equipment: BK-81 Truck Hammer Type: Automatic
 Horiz. Datum: NAD83 Offset: ~ Other Comments:

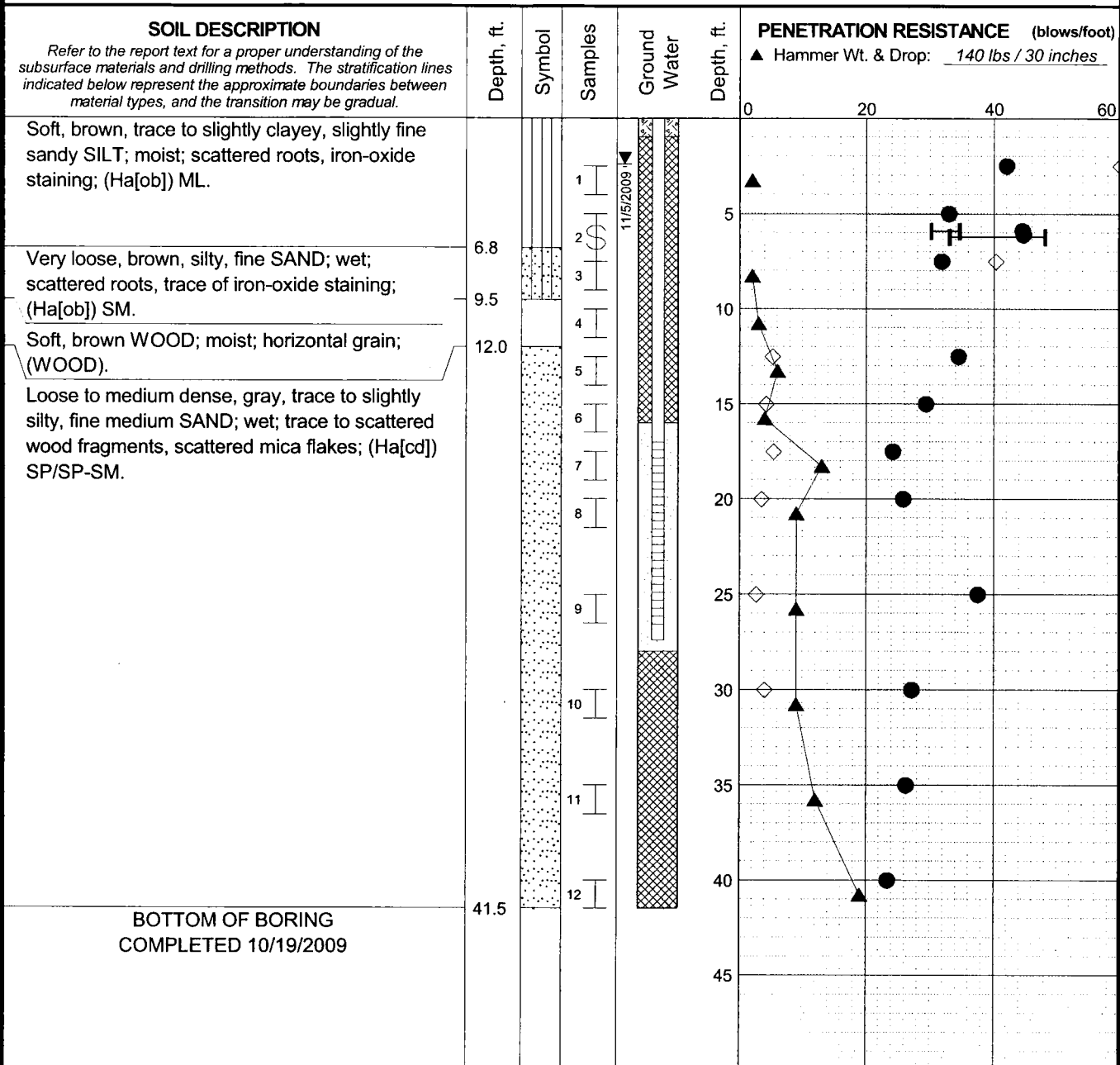

Log: EYP Rev: JKN Typ: LKN MASTER LOG E 21-21199.GPJ SHAN WIL GDT 6/1/10

- LEGEND**
- * Sample Not Recovered
 - [Symbol] Standard Penetration Test
 - [Symbol] 3" O.D. Thin-Walled Tube
 - [Symbol] Piezometer Screen and Sand Filter
 - [Symbol] Bentonite-Cement Grout
 - [Symbol] Bentonite Chips/Pellets
 - [Symbol] Bentonite Grout
 - ▼ Ground Water Level in Well
 - ◇ % Fines (<0.075mm)
 - % Water Content
 - Liquid Limit
 - Plastic Limit
 - Natural Water Content

- NOTES**
- Refer to KEY for explanation of symbols, codes, abbreviations and definitions.
 - The stratification lines represent the approximate boundaries between soil types, and the transition may be gradual.
 - The discussion in the text of this report is necessary for a proper understanding of the nature of the subsurface materials.
 - Groundwater level, if indicated above, is for the date specified and may vary.
 - USCS designation is based on visual-manual classification and selected lab testing.

Skagit River Levee General Investigation
 Skagit County, Washington

LOG OF BORING DD1-2 Landward

June 2010 21-21199-002

SHANNON & WILSON, INC.
 Geotechnical and Environmental Consultants

FIG. A-4

Total Depth: 61.5 ft. Northing: ~ 508,713 ft. Drilling Method: Mud Rotary Hole Diam.: 5 in.
 Top Elevation: ~ Easting: ~ 1,263,901 ft. Drilling Company: Holocene Drilling Rod Diam.: NWJ
 Vert. Datum: ~ Station: ~ Drill Rig Equipment: BK-81 Truck Hammer Type: Automatic
 Horiz. Datum: NAD83 Offset: ~ Other Comments:

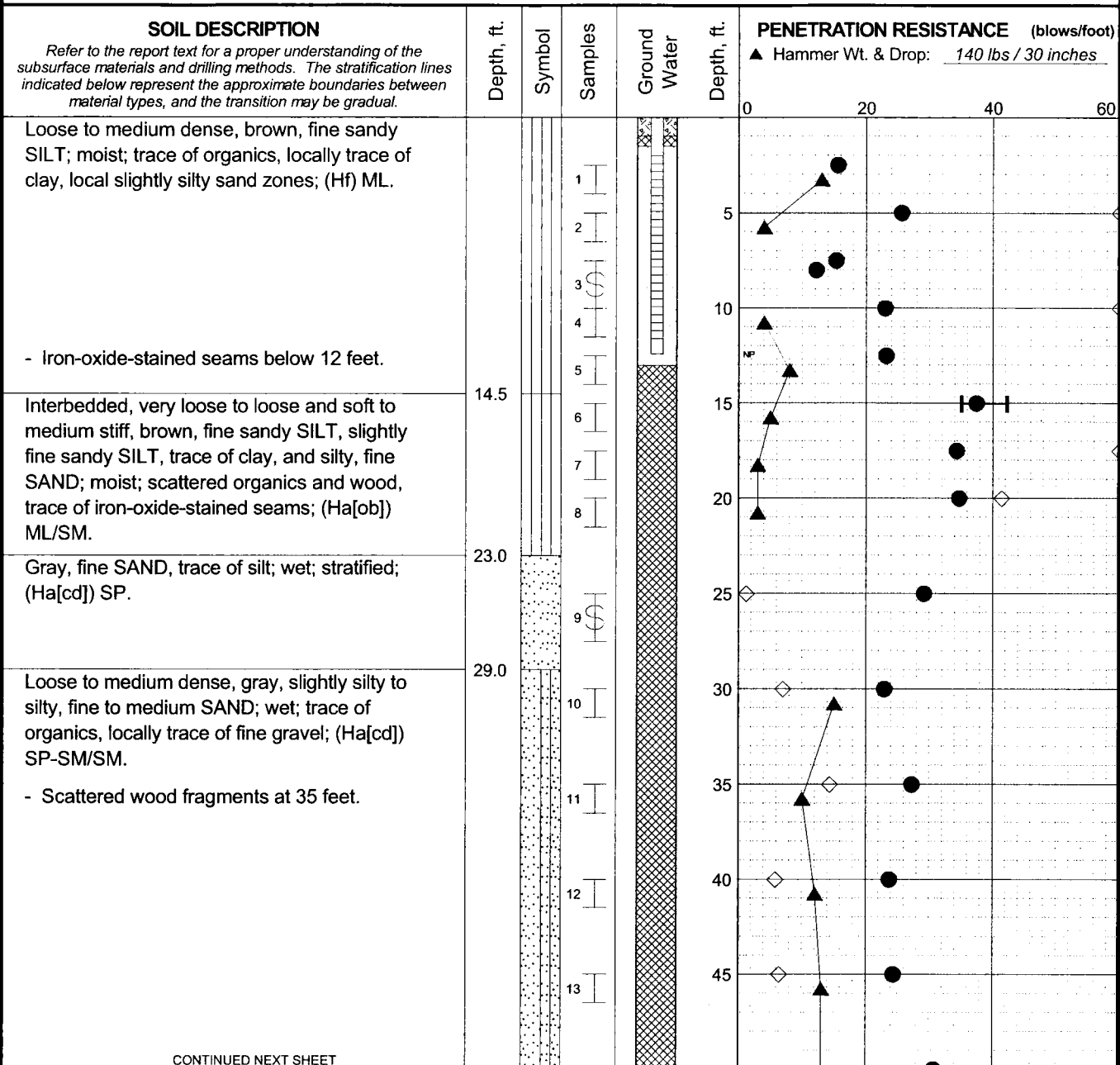

CONTINUED NEXT SHEET

- LEGEND**
- * Sample Not Recovered
 - Standard Penetration Test
 - 3" O.D. Thin-Walled Tube
 - Piezometer Screen and Sand Filter
 - Bentonite-Cement Grout
 - Bentonite Chips/Pellets
 - Bentonite Grout
 - ◇ % Fines (<0.075mm)
 - % Water Content
 - Liquid Limit
 - Natural Water Content

NOTES

1. Refer to KEY for explanation of symbols, codes, abbreviations and definitions.
2. The stratification lines represent the approximate boundaries between soil types, and the transition may be gradual.
3. The discussion in the text of this report is necessary for a proper understanding of the nature of the subsurface materials.
4. Groundwater level, if indicated above, is for the date specified and may vary.
5. USCS designation is based on visual-manual classification and selected lab testing.

Skagit River Levee General Investigation
 Skagit County, Washington

LOG OF BORING DD1-2 Levee

June 2010 21-1-21199-002

SHANNON & WILSON, INC.
 Geotechnical and Environmental Consultants

FIG. A-5
 Sheet 1 of 2

MASTER LOG E 21-21199.GPJ SHAN WIL GDT 6/1/10 Log: EVP Rev: JKN Typ: LKN

Total Depth: 61.5 ft. Northing: ~ 508,713 ft. Drilling Method: Mud Rotary Hole Diam.: 5 in.
 Top Elevation: ~ Easting: ~ 1,263,901 ft. Drilling Company: Holocene Drilling Rod Diam.: NWJ
 Vert. Datum: ~ Station: ~ Drill Rig Equipment: BK-81 Truck Hammer Type: Automatic
 Horiz. Datum: NAD83 Offset: ~ Other Comments: ~

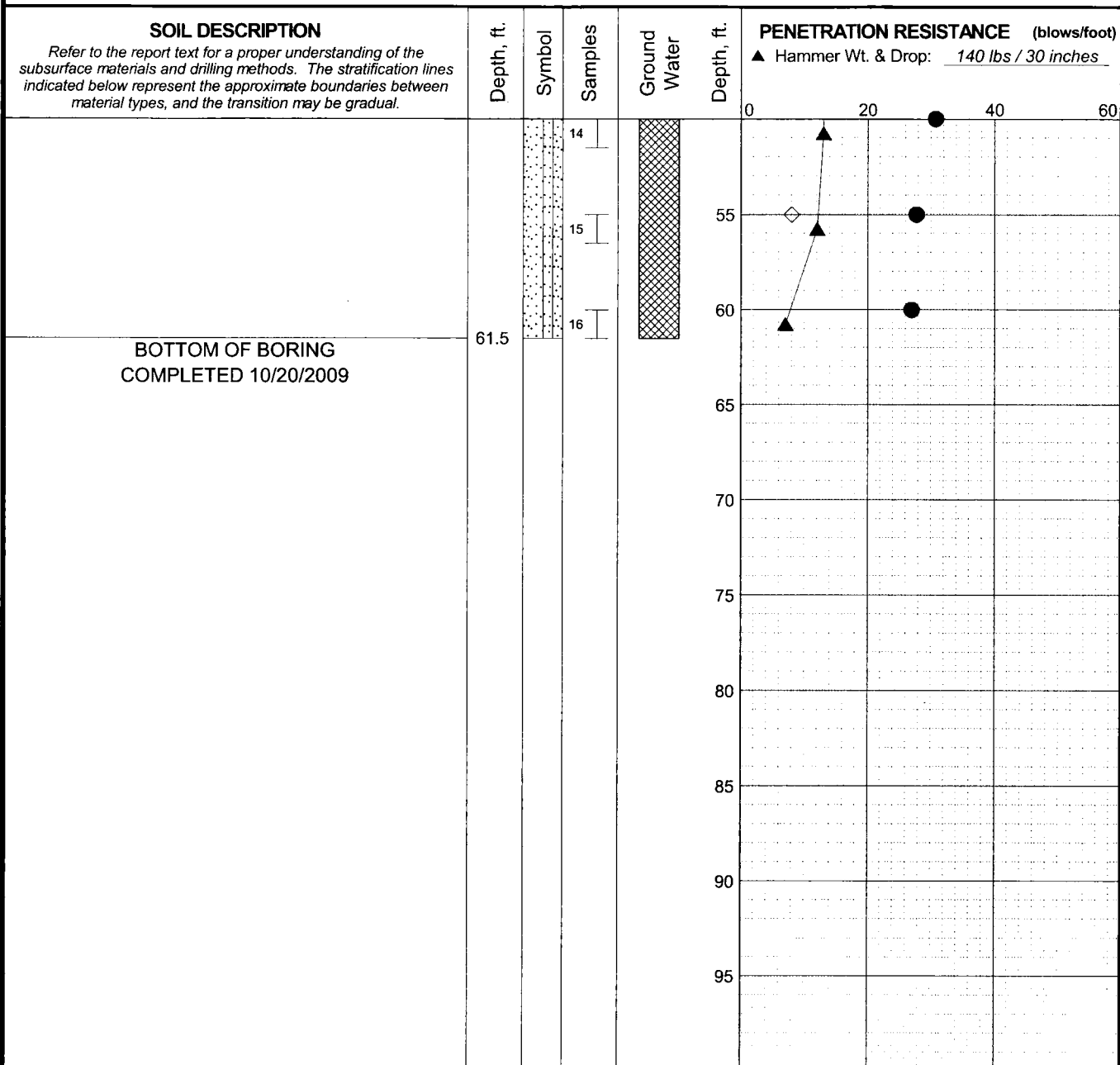

Log: EVP Rev: JKN Typ: LKN
MASTER LOG E 21-21199.GPJ SHAN_WIL_GDT 6/1/10

LEGEND

* Sample Not Recovered		Piezometer Screen and Sand Filter		% Fines (<0.075mm)
		Bentonite-Cement Grout		% Water Content
		Bentonite Chips/Pellets		Liquid Limit
		Bentonite Grout		Natural Water Content

- NOTES**
1. Refer to KEY for explanation of symbols, codes, abbreviations and definitions.
 2. The stratification lines represent the approximate boundaries between soil types, and the transition may be gradual.
 3. The discussion in the text of this report is necessary for a proper understanding of the nature of the subsurface materials.
 4. Groundwater level, if indicated above, is for the date specified and may vary.
 5. USCS designation is based on visual-manual classification and selected lab testing.

Skagit River Levee General Investigation
Skagit County, Washington

LOG OF BORING DD1-2 Levee

June 2010 21-21199-002

SHANNON & WILSON, INC. Geotechnical and Environmental Consultants	FIG. A-5 Sheet 2 of 2
---	---------------------------------

Total Depth: <u>41.5 ft.</u>	Northing: <u>~ 507,123 ft.</u>	Drilling Method: <u>Mud Rotary</u>	Hole Diam.: <u>5 in.</u>
Top Elevation: <u>~</u>	Easting: <u>~ 1,269,522 ft.</u>	Drilling Company: <u>Holocene Drilling</u>	Rod Diam.: <u>NWJ</u>
Vert. Datum: <u>~</u>	Station: <u>~</u>	Drill Rig Equipment: <u>BK-81 Truck</u>	Hammer Type: <u>Automatic</u>
Horiz. Datum: <u>NAD83</u>	Offset: <u>~</u>	Other Comments: <u></u>	

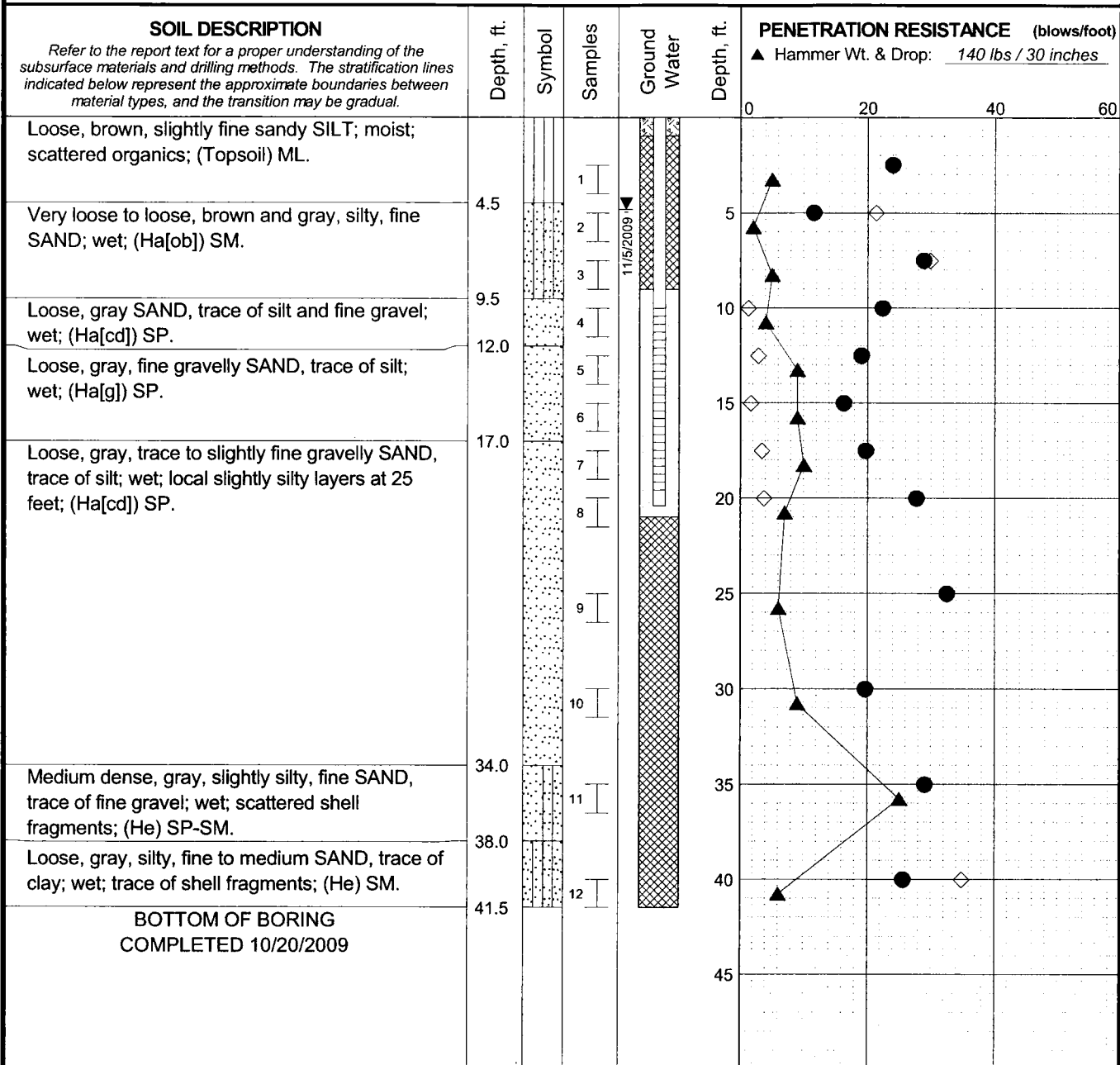

Log: EVP Rev: JKN Typ: LKN
 MASTER LOG E 21-21199.GPJ SHAN WIL GDT 6/1/10

LEGEND

* Sample Not Recovered	[Symbol]	Piezometer Screen and Sand Filter	◇ % Fines (<0.075mm)
[Symbol] Standard Penetration Test	[Symbol]	Bentonite-Cement Grout	● % Water Content
	[Symbol]	Bentonite Chips/Pellets	
	[Symbol]	Bentonite Grout	
	▼	Ground Water Level in Well	

- NOTES**
1. Refer to KEY for explanation of symbols, codes, abbreviations and definitions.
 2. The stratification lines represent the approximate boundaries between soil types, and the transition may be gradual.
 3. The discussion in the text of this report is necessary for a proper understanding of the nature of the subsurface materials.
 4. Groundwater level, if indicated above, is for the date specified and may vary.
 5. USCS designation is based on visual-manual classification and selected lab testing.

Skagit River Levee General Investigation
Skagit County, Washington

LOG OF BORING DD3-1 Landward

June 2010 21-1-21199-002

SHANNON & WILSON, INC. Geotechnical and Environmental Consultants	FIG. A-6
---	-----------------

Total Depth: 61.5 ft. Northing: ~ 507,134 ft. Drilling Method: Mud Rotary Hole Diam.: 5 in.
 Top Elevation: ~ Easting: ~ 1,269,453 ft. Drilling Company: Holocene Drilling Rod Diam.: NWJ
 Vert. Datum: ~ Station: ~ Drill Rig Equipment: BK-81 Truck Hammer Type: Automatic
 Horiz. Datum: NAD83 Offset: ~ Other Comments: ~

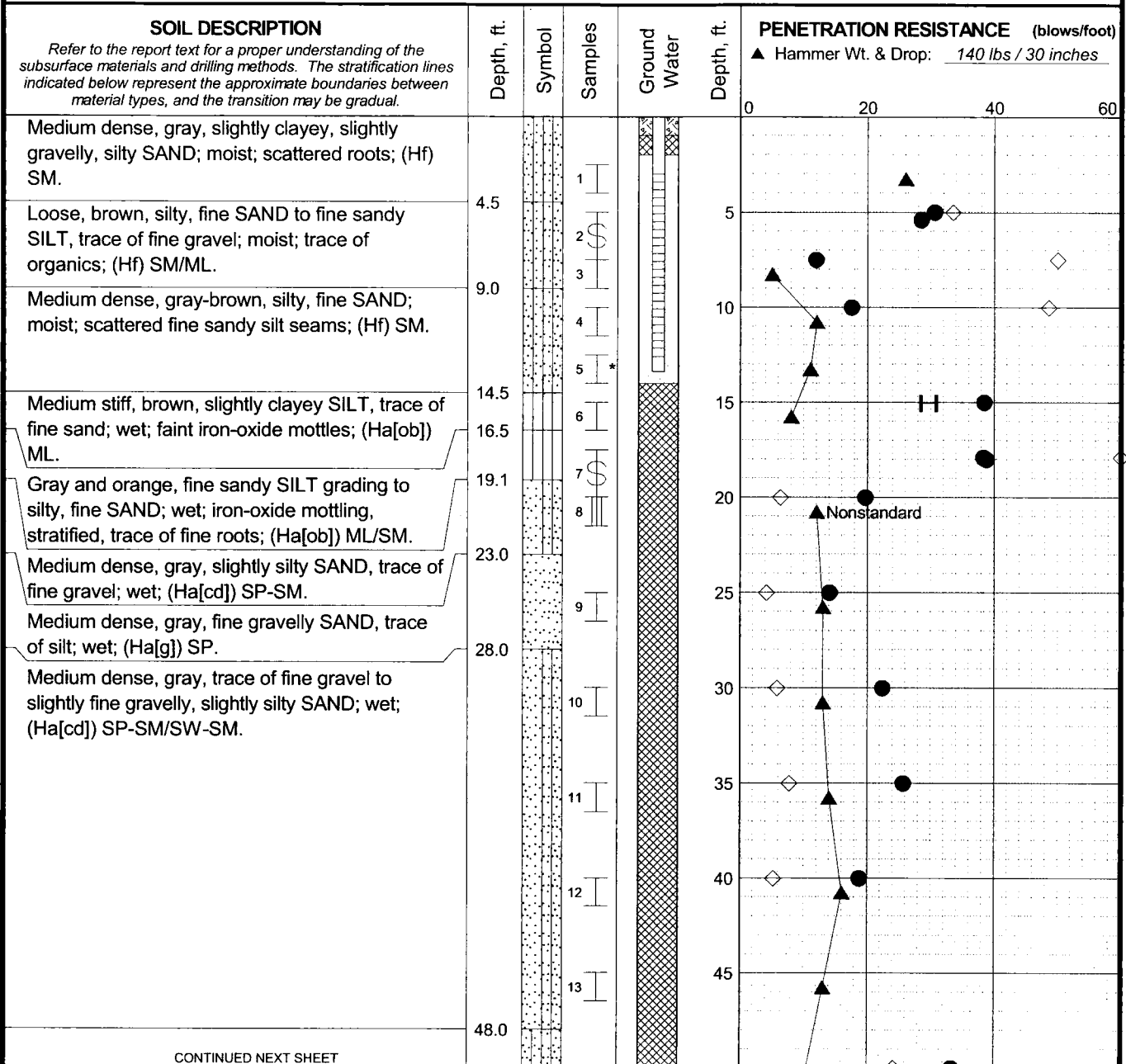

CONTINUED NEXT SHEET

- LEGEND**
- * Sample Not Recovered
 - I Standard Penetration Test
 - ⊗ 3" O.D. Thin-Walled Tube
 - ⊔ 3" O.D. Split Spoon Sample
 - Piezometer Screen and Sand Filter
 - ▨ Bentonite-Cement Grout
 - ▩ Bentonite Chips/Pellets
 - ▧ Bentonite Grout
 - ◇ % Fines (<0.075mm)
 - % Water Content
 - Plastic Limit
 - Liquid Limit
 - Natural Water Content

- NOTES**
- Refer to KEY for explanation of symbols, codes, abbreviations and definitions.
 - The stratification lines represent the approximate boundaries between soil types, and the transition may be gradual.
 - The discussion in the text of this report is necessary for a proper understanding of the nature of the subsurface materials.
 - Groundwater level, if indicated above, is for the date specified and may vary.
 - USCS designation is based on visual-manual classification and selected lab testing.

Skagit River Levee General Investigation
Skagit County, Washington

LOG OF BORING DD3-1 Levee

June 2010 21-1-21199-002

SHANNON & WILSON, INC.
Geotechnical and Environmental Consultants

FIG. A-7
Sheet 1 of 2

Log: EYP Rev: JKN Typ: LKN
MASTER LOG E 21-21199-GPJ SHAN WIL GDT 6/1/10

Total Depth: 61.5 ft. Northing: ~ 507,134 ft. Drilling Method: Mud Rotary Hole Diam.: 5 in.
 Top Elevation: ~ Easting: ~ 1,269,453 ft. Drilling Company: Holocene Drilling Rod Diam.: NWJ
 Vert. Datum: ~ Station: ~ Drill Rig Equipment: BK-81 Truck Hammer Type: Automatic
 Horiz. Datum: NAD83 Offset: ~ Other Comments: ~

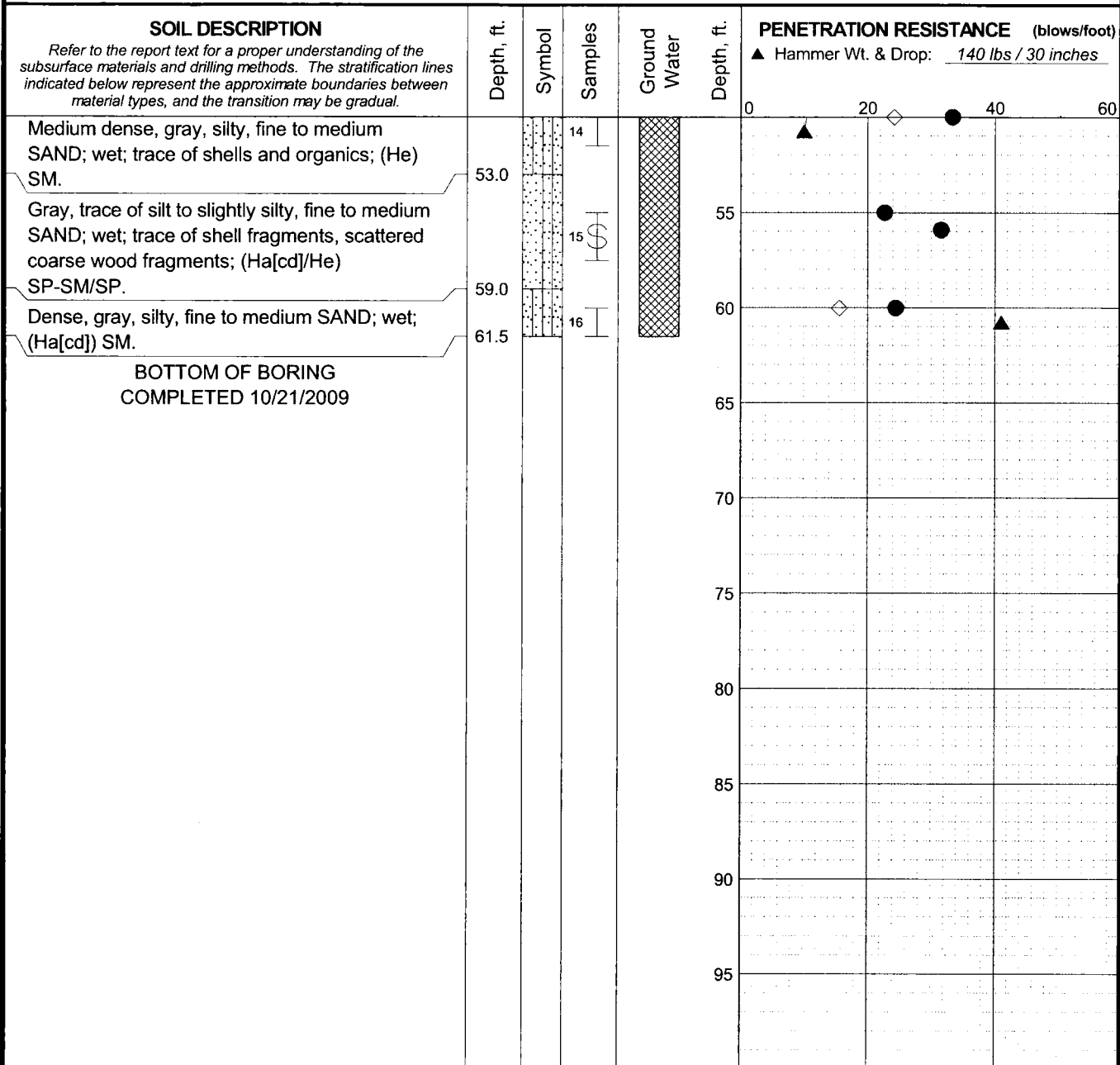

Log: EVP Rev: JKN Typ: LKN
 MASTER LOG E 21-21199.GPJ SHAN WIL GDT 6/17/10

LEGEND		
* Sample Not Recovered	[Symbol]	Piezometer Screen and Sand Filter
[Symbol]	[Symbol]	Bentonite-Cement Grout
[Symbol]	[Symbol]	Bentonite Chips/Pellets
[Symbol]	[Symbol]	Bentonite Grout
[Symbol]	[Symbol]	◇ % Fines (<0.075mm)
[Symbol]	[Symbol]	● % Water Content
[Symbol]	[Symbol]	Plastic Limit —●— Liquid Limit
[Symbol]	[Symbol]	Natural Water Content

- NOTES**
- Refer to KEY for explanation of symbols, codes, abbreviations and definitions.
 - The stratification lines represent the approximate boundaries between soil types, and the transition may be gradual.
 - The discussion in the text of this report is necessary for a proper understanding of the nature of the subsurface materials.
 - Groundwater level, if indicated above, is for the date specified and may vary.
 - USCS designation is based on visual-manual classification and selected lab testing.

Skagit River Levee General Investigation
 Skagit County, Washington

LOG OF BORING DD3-1 Levee

June 2010 21-1-21199-002

SHANNON & WILSON, INC. Geotechnical and Environmental Consultants	FIG. A-7 Sheet 2 of 2
---	---------------------------------

Total Depth: 43.5 ft. Northing: ~ 530,262 ft. Drilling Method: Mud Rotary Hole Diam.: 5 in.
 Top Elevation: ~ Easting: ~ 1,277,725 ft. Drilling Company: Holocene Drilling Rod Diam.: NWJ
 Vert. Datum: ~ Station: ~ Drill Rig Equipment: B-61 Mobile Truck Hammer Type: Automatic
 Horiz. Datum: NAD83 Offset: ~ Other Comments: ~

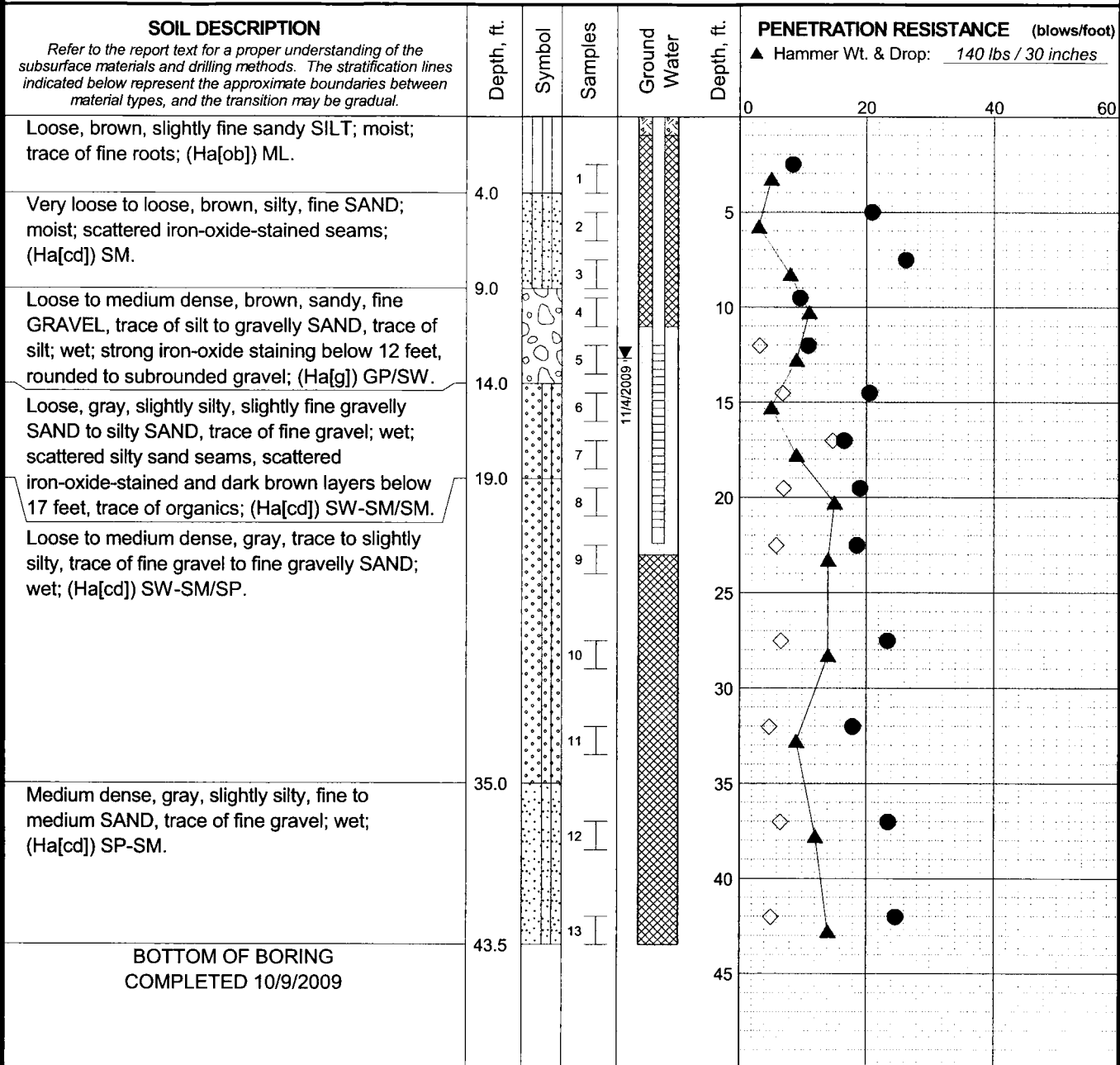

Log: EYP Rev: JKN Typ: CLP
 MASTER LOG E 21-1-21199.GPJ SHAN WIL GDT 6/1/10

LEGEND

- * Sample Not Recovered
- [Symbol] Standard Penetration Test
- [Symbol] Piezometer Screen and Sand Filter
- [Symbol] Bentonite-Cement Grout
- [Symbol] Bentonite Chips/Pellets
- [Symbol] Bentonite Grout
- ▼ Ground Water Level in Well
- ◇ % Fines (<0.075mm)
- % Water Content

NOTES

1. Refer to KEY for explanation of symbols, codes, abbreviations and definitions.
2. The stratification lines represent the approximate boundaries between soil types, and the transition may be gradual.
3. The discussion in the text of this report is necessary for a proper understanding of the nature of the subsurface materials.
4. Groundwater level, if indicated above, is for the date specified and may vary.
5. USCS designation is based on visual-manual classification and selected lab testing.

Skagit River Levee General Investigation
 Skagit County, Washington

LOG OF BORING DD17-1 Landward

June 2010 21-1-21199-002

SHANNON & WILSON, INC.
 Geotechnical and Environmental Consultants

FIG. A-8

Total Depth: 63.5 ft.	Northing: ~ 530,351 ft.	Drilling Method: Mud Rotary	Hole Diam.: 5 in.
Top Elevation: ~	Easting: ~ 1,277,702 ft.	Drilling Company: Holocene Drilling	Rod Diam.: NWJ
Vert. Datum: ~	Station: ~	Drill Rig Equipment: B-61 Mobile Truck	Hammer Type: Automatic
Horiz. Datum: NAD83	Offset: ~	Other Comments:	

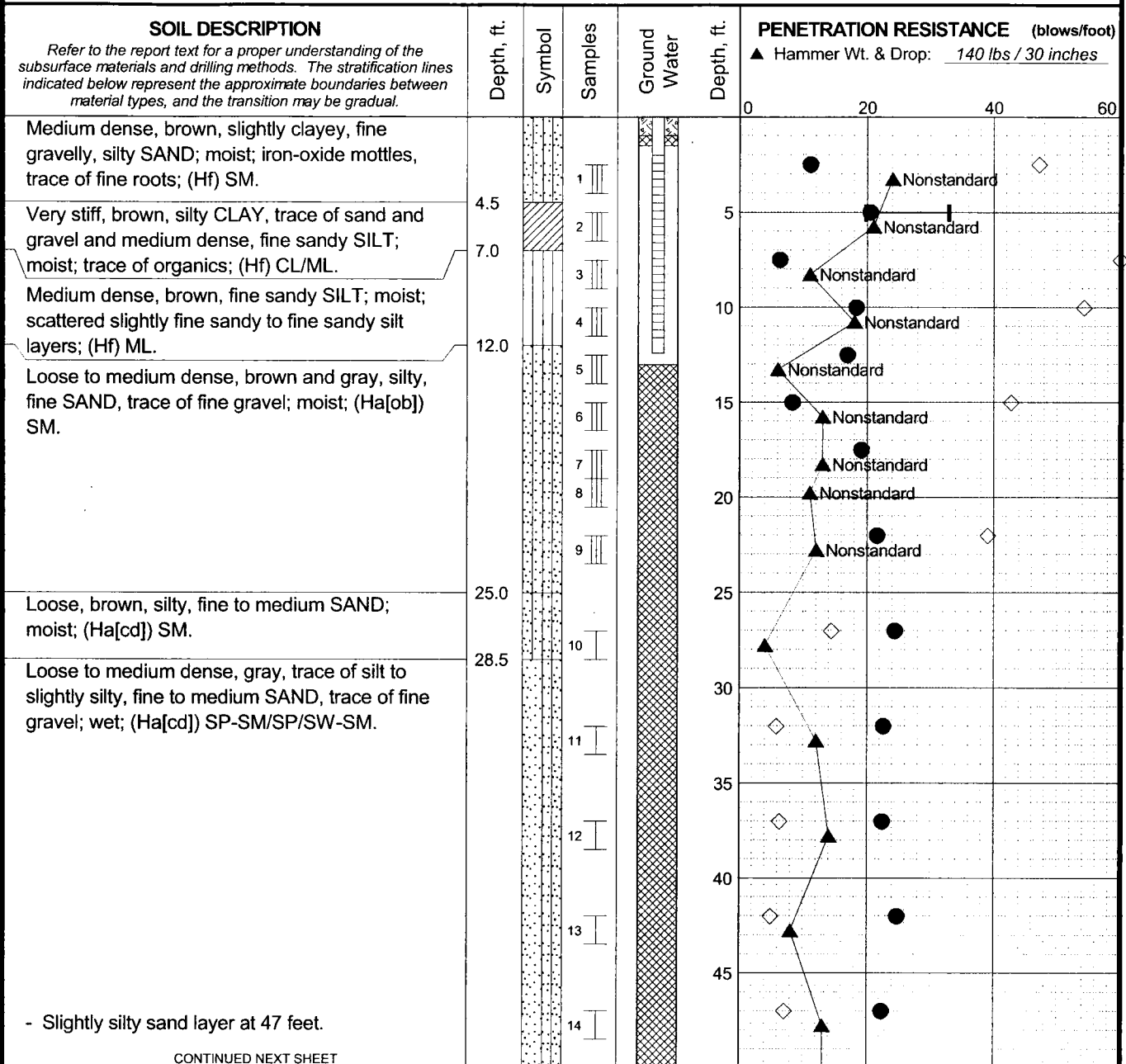

CONTINUED NEXT SHEET

LEGEND	
* Sample Not Recovered	□ Piezometer Screen and Sand Filter
▨ 3" O.D. Split Spoon Sample	▨ Bentonite-Cement Grout
⊥ Standard Penetration Test	▨ Bentonite Chips/Pellets
	▨ Bentonite Grout
	◇ % Fines (<0.075mm)
	● % Water Content
	—●— Liquid Limit
	— Natural Water Content

NOTES

1. Refer to KEY for explanation of symbols, codes, abbreviations and definitions.
2. The stratification lines represent the approximate boundaries between soil types, and the transition may be gradual.
3. The discussion in the text of this report is necessary for a proper understanding of the nature of the subsurface materials.
4. Groundwater level, if indicated above, is for the date specified and may vary.
5. USCS designation is based on visual-manual classification and selected lab testing.

Skagit River Levee General Investigation
Skagit County, Washington

LOG OF BORING DD17-1 Levee

June 2010

21-21199-002

SHANNON & WILSON, INC.
Geotechnical and Environmental Consultants







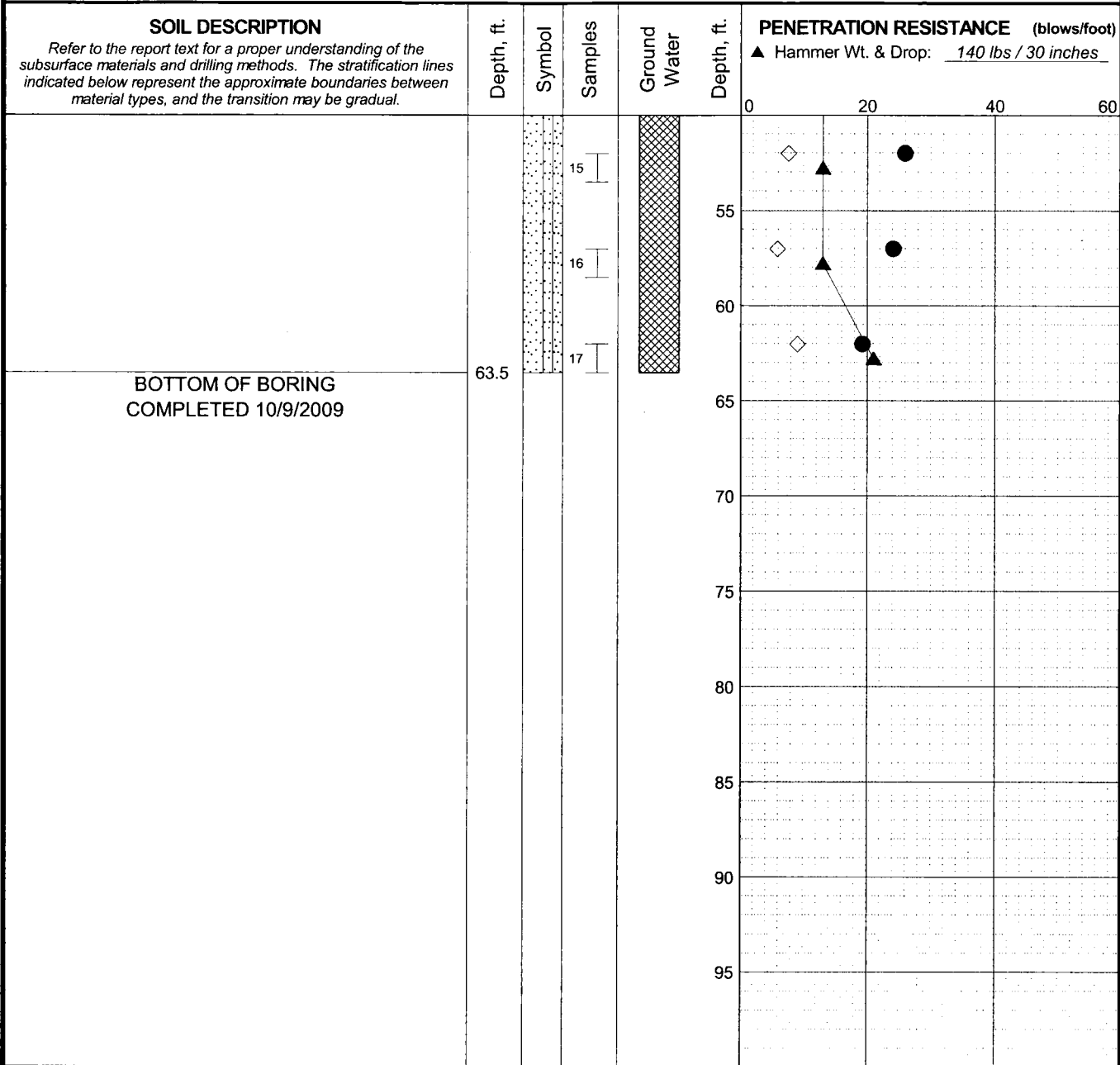

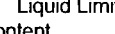

FIG. A-9
Sheet 1 of 2

MASTER LOG E 21-21199.GPJ SHAN WIL GDT 6/1/10 Log: EYP Rev: JKN Typ: CLP

Total Depth: <u>63.5 ft.</u>	Northing: <u>~ 530,351 ft.</u>	Drilling Method: <u>Mud Rotary</u>	Hole Diam.: <u>5 in.</u>
Top Elevation: <u>~</u>	Easting: <u>~ 1,277,702 ft.</u>	Drilling Company: <u>Holocene Drilling</u>	Rod Diam.: <u>NWJ</u>
Vert. Datum: <u>~</u>	Station: <u>~</u>	Drill Rig Equipment: <u>B-61 Mobile Truck</u>	Hammer Type: <u>Automatic</u>
Horiz. Datum: <u>NAD83</u>	Offset: <u>~</u>	Other Comments: <u>~</u>	

 Log: EYP Rev: JKN Typ: CLP
 MASTER LOG E 21-21199.GPJ SHAN WIL.GDT 6/1/10

LEGEND

- | | | | | | |
|---|---|---|---|---|--|
| * Sample Not Recovered |  | Piezometer Screen and Sand Filter |  | % Fines (<0.075mm) | |
|  | 3" O.D. Split Spoon Sample |  | Bentonite-Cement Grout |  | % Water Content |
|  | Standard Penetration Test |  | Bentonite Chips/Pellets | Plastic Limit  | Liquid Limit  |
| | |  | Bentonite Grout | Natural Water Content | |

NOTES

1. Refer to KEY for explanation of symbols, codes, abbreviations and definitions.
2. The stratification lines represent the approximate boundaries between soil types, and the transition may be gradual.
3. The discussion in the text of this report is necessary for a proper understanding of the nature of the subsurface materials.
4. Groundwater level, if indicated above, is for the date specified and may vary.
5. USCS designation is based on visual-manual classification and selected lab testing.

Skagit River Levee General Investigation Skagit County, Washington	
LOG OF BORING DD17-1 Levee	
June 2010	21-1-21199-002
SHANNON & WILSON, INC. Geotechnical and Environmental Consultants	FIG. A-9 Sheet 2 of 2

Total Depth: 38.5 ft.	Northing: ~ 531,266 ft.	Drilling Method: Mud Rotary	Hole Diam.: 5 in.
Top Elevation: ~	Easting: ~ 1,270,707 ft.	Drilling Company: Holocene Drilling	Rod Diam.: NWJ
Vert. Datum: ~	Station: ~	Drill Rig Equipment: B-61 Mobile Truck	Hammer Type: Automatic
Horiz. Datum: NAD83	Offset: ~	Other Comments:	

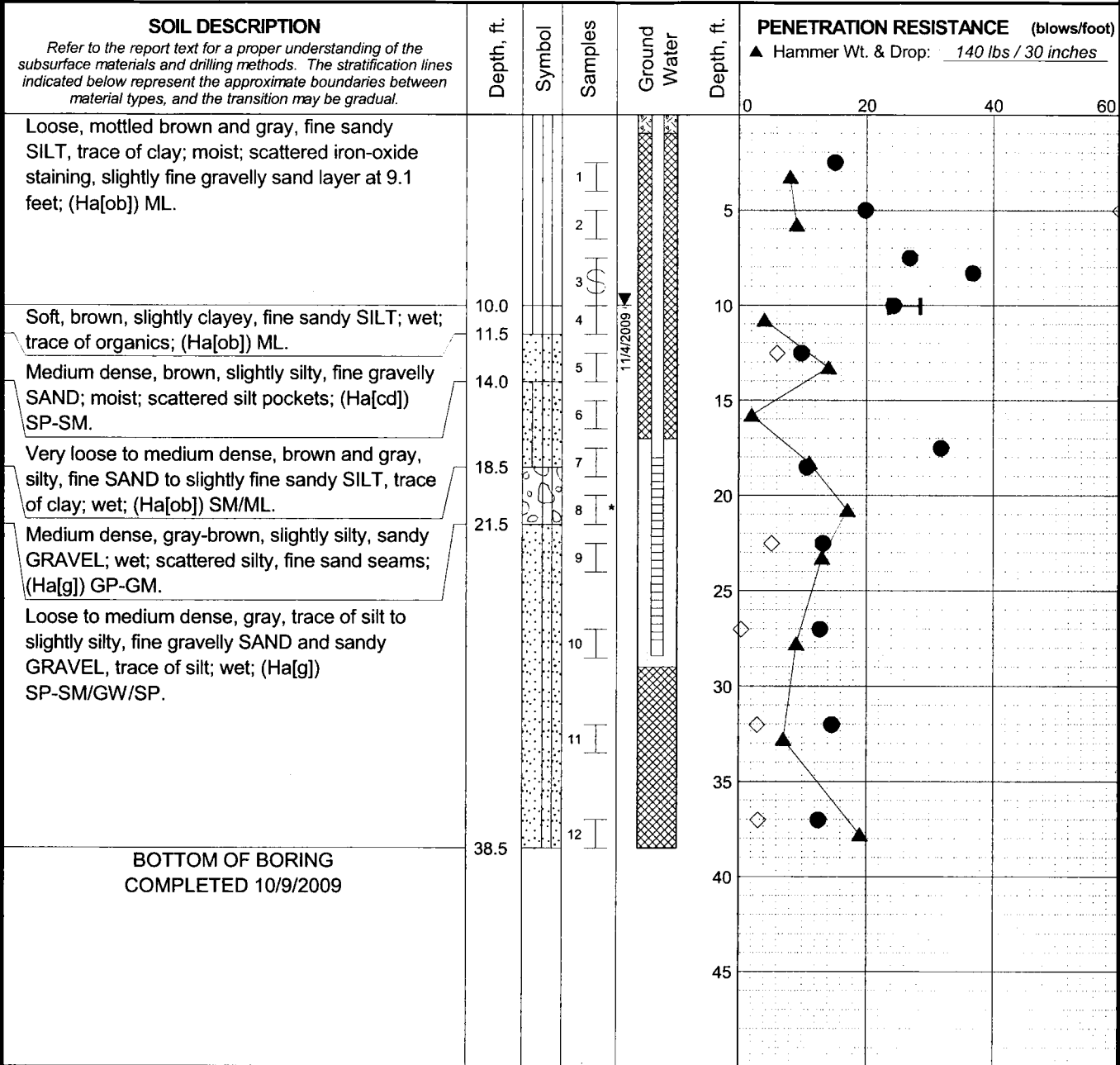

Log: EYP Rev: JKN Typ: CLP
 MASTER LOG E 21-21199.GPJ SHAN_WIL_GDT 6/1/10

Skagit River Levee General Investigation
Skagit County, Washington

LOG OF BORING DD17-2 Landward

June 2010 21-21199-002

SHANNON & WILSON, INC. Geotechnical and Environmental Consultants	FIG. A-10
---	------------------

Total Depth: 63.5 ft. Northing: ~ 531,153 ft. Drilling Method: Mud Rotary Hole Diam.: 5 in.
 Top Elevation: ~ Easting: ~ 1,270,679 ft. Drilling Company: Holocene Drilling Rod Diam.: JWJ
 Vert. Datum: Station: ~ Drill Rig Equipment: B-61 Mobile Truck Hammer Type: Automatic
 Horiz. Datum: NAD83 Offset: ~ Other Comments:

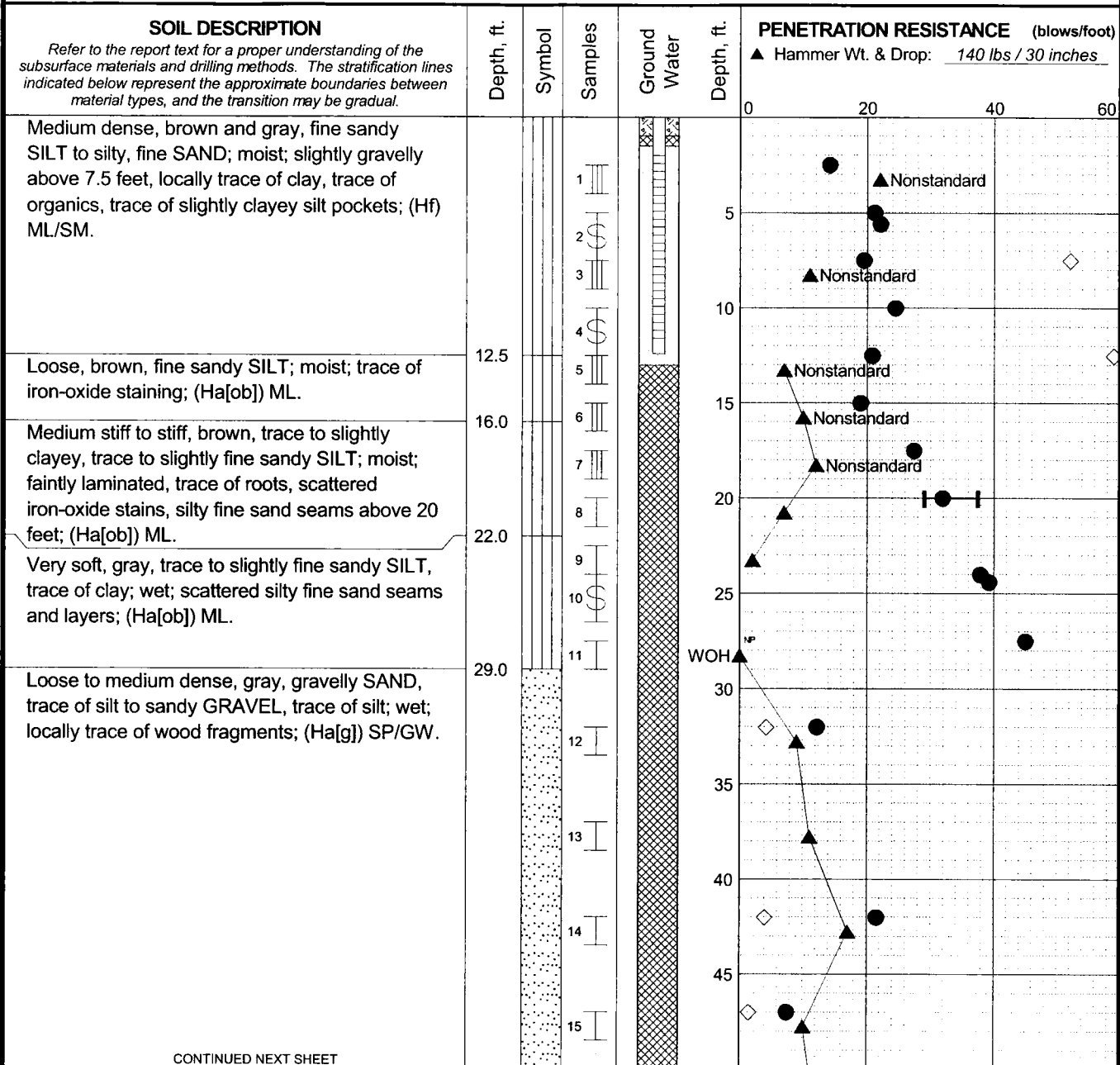

Log: EYP Rev: JKN Typ: CLP
 MASTER LOG E 21-21199.GPJ SHAN_WIL_GDT 6/1/10

- LEGEND**
- * Sample Not Recovered
 - Piezometer Screen and Sand Filter
 - ◇ % Fines (<0.075mm)
 - ▨ 3" O.D. Split Spoon Sample
 - ▩ Bentonite-Cement Grout
 - % Water Content
 - ⊞ 3" O.D. Thin-Walled Tube
 - ▩ Bentonite Chips/Pellets
 - Liquid Limit
 - ⊞ Standard Penetration Test
 - ▩ Bentonite Grout
 - Natural Water Content

- NOTES**
- Refer to KEY for explanation of symbols, codes, abbreviations and definitions.
 - The stratification lines represent the approximate boundaries between soil types, and the transition may be gradual.
 - The discussion in the text of this report is necessary for a proper understanding of the nature of the subsurface materials.
 - Groundwater level, if indicated above, is for the date specified and may vary.
 - USCS designation is based on visual-manual classification and selected lab testing.

Skagit River Levee General Investigation
 Skagit County, Washington

LOG OF BORING DD17-2 Levee

June 2010
21-21199-002

SHANNON & WILSON, INC.
Geotechnical and Environmental Consultants
FIG. A-11
Sheet 1 of 2

Total Depth: 63.5 ft. Northing: ~ 531,153 ft. Drilling Method: Mud Rotary Hole Diam.: 5 in.
 Top Elevation: ~ Easting: ~ 1,270,679 ft. Drilling Company: Holocene Drilling Rod Diam.: JWJ
 Vert. Datum: ~ Station: ~ Drill Rig Equipment: B-61 Mobile Truck Hammer Type: Automatic
 Horiz. Datum: NAD83 Offset: ~ Other Comments:

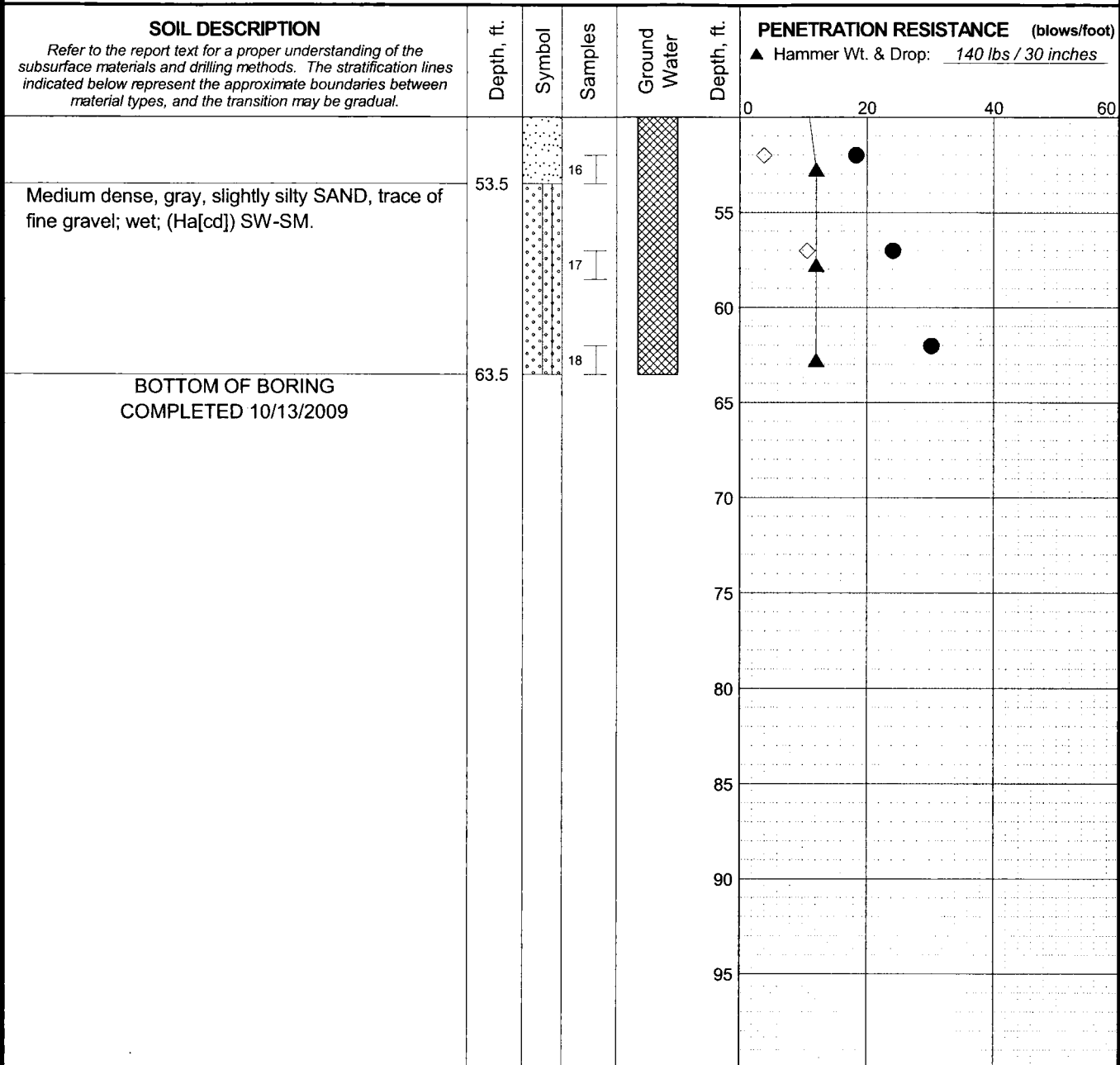

Log: EVP Rev: JKN Typ: CLP
MASTER LOG E 21-21199.GPJ SHAN_WIL_GDT 6/1/10

- LEGEND**
- * Sample Not Recovered
 - Piezometer Screen and Sand Filter
 - % Fines (<0.075mm) symbol"/> % Fines (<0.075mm)
 - 3" O.D. Split Spoon Sample
 - Bentonite-Cement Grout
 - % Water Content symbol"/> % Water Content
 - 3" O.D. Thin-Walled Tube
 - Bentonite Chips/Pellets
 - Plastic Limit
 - Standard Penetration Test
 - Bentonite Grout
 - Liquid Limit
 - Natural Water Content

- NOTES**
- Refer to KEY for explanation of symbols, codes, abbreviations and definitions.
 - The stratification lines represent the approximate boundaries between soil types, and the transition may be gradual.
 - The discussion in the text of this report is necessary for a proper understanding of the nature of the subsurface materials.
 - Groundwater level, if indicated above, is for the date specified and may vary.
 - USCS designation is based on visual-manual classification and selected lab testing.

Skagit River Levee General Investigation
Skagit County, Washington

LOG OF BORING DD17-2 Levee

June 2010
21-1-21199-002

SHANNON & WILSON, INC.
Geotechnical and Environmental Consultants
FIG. A-11
Sheet 2 of 2

Total Depth: 51.5 ft. Northing: ~ 525,350 ft. Drilling Method: Mud Rotary Hole Diam.: 5 in.
 Top Elevation: ~ Easting: ~ 1,272,695 ft. Drilling Company: Holocene Drilling Rod Diam.: NWJ
 Vert. Datum: ~ Station: ~ Drill Rig Equipment: B-61 Mobile Truck Hammer Type: Automatic
 Horiz. Datum: NAD83 Offset: ~ Other Comments:

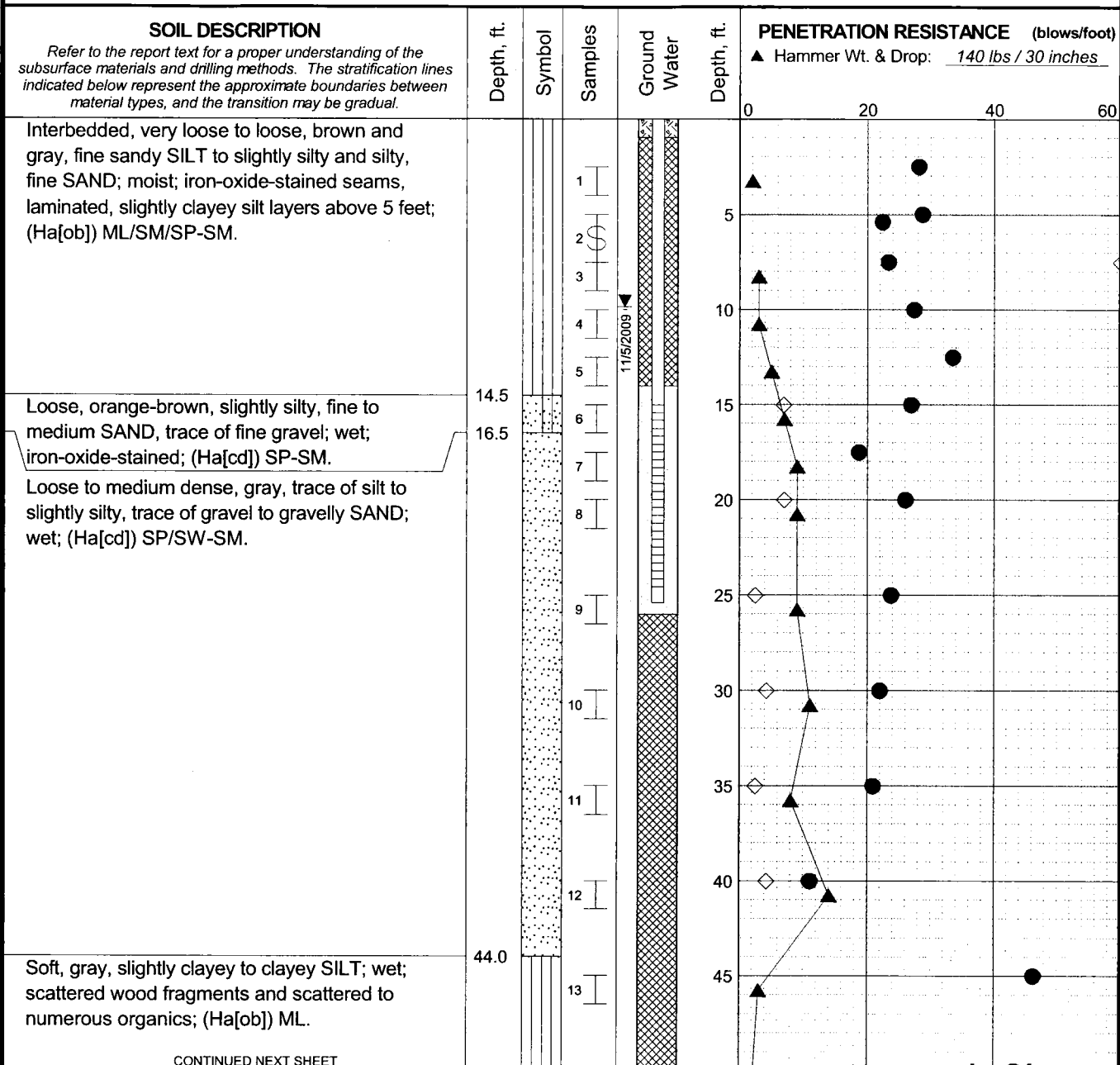

Log: EVP Rev: JKN Typ: CLP
 MASTER LOG E 21-21199.GPJ SHAN WIL.GDT 6/1/10

CONTINUED NEXT SHEET

LEGEND

- * Sample Not Recovered
- Standard Penetration Test
- 3" O.D. Thin-Walled Tube
- Piezometer Screen and Sand Filter
- Bentonite-Cement Grout
- Bentonite Chips/Pellets
- Bentonite Grout
- Ground Water Level in Well
- \diamond % Fines (<math><0.075\text{mm}</math>)
- \bullet % Water Content
- Plastic Limit
- Liquid Limit
- Natural Water Content

NOTES

1. Refer to KEY for explanation of symbols, codes, abbreviations and definitions.
2. The stratification lines represent the approximate boundaries between soil types, and the transition may be gradual.
3. The discussion in the text of this report is necessary for a proper understanding of the nature of the subsurface materials.
4. Groundwater level, if indicated above, is for the date specified and may vary.
5. USCS designation is based on visual-manual classification and selected lab testing.

Skagit River Levee General Investigation
 Skagit County, Washington

LOG OF BORING DD17-3 Landward

June 2010

21-1-21199-002

SHANNON & WILSON, INC.
 Geotechnical and Environmental Consultants

FIG. A-12
 Sheet 1 of 2

Total Depth: 51.5 ft. Northing: ~ 525,350 ft. Drilling Method: Mud Rotary Hole Diam.: 5 in.
 Top Elevation: ~ Easting: ~ 1,272,695 ft. Drilling Company: Holocene Drilling Rod Diam.: NWJ
 Vert. Datum: ~ Station: ~ Drill Rig Equipment: B-61 Mobile Truck Hammer Type: Automatic
 Horiz. Datum: NAD83 Offset: ~ Other Comments: ~

SOIL DESCRIPTION <i>Refer to the report text for a proper understanding of the subsurface materials and drilling methods. The stratification lines indicated below represent the approximate boundaries between material types, and the transition may be gradual.</i>	Depth, ft.	Symbol	Samples	Ground Water	Depth, ft.	PENETRATION RESISTANCE (blows/foot)			
						▲ Hammer Wt. & Drop: <u>140 lbs / 30 inches</u>			
					0	20	40	60	
BOTTOM OF BORING COMPLETED 10/15/2009	51.5		14		0				
					55				
					60				
					65				
					70				
					75				
					80				
					85				
					90				
					95				

Log: EVP Rev: JKN Typ: CLP
MASTER LOG E 21-21199.GPJ SHAN_WIL.GDT 6/1/10

- LEGEND**
- * Sample Not Recovered
 - Standard Penetration Test
 - 3" O.D. Thin-Walled Tube
 - Piezometer Screen and Sand Filter
 - Bentonite-Cement Grout
 - Bentonite Chips/Pellets
 - Bentonite Grout
 - Ground Water Level in Well
 - % Fines (<0.075mm)
 - % Water Content
 - Plastic Limit
 - Liquid Limit
 - Natural Water Content

- NOTES**
- Refer to KEY for explanation of symbols, codes, abbreviations and definitions.
 - The stratification lines represent the approximate boundaries between soil types, and the transition may be gradual.
 - The discussion in the text of this report is necessary for a proper understanding of the nature of the subsurface materials.
 - Groundwater level, if indicated above, is for the date specified and may vary.
 - USCS designation is based on visual-manual classification and selected lab testing.

Skagit River Levee General Investigation
Skagit County, Washington

LOG OF BORING DD17-3 Landward

June 2010 21-1-21199-002

SHANNON & WILSON, INC.
Geotechnical and Environmental Consultants

FIG. A-12
Sheet 2 of 2

Total Depth: 66 ft.	Northing: ~ 525,290 ft.	Drilling Method: Mud Rotary	Hole Diam.: 5 in.
Top Elevation: ~	Easting: ~ 1,272,702 ft.	Drilling Company: Holocene Drilling	Rod Diam.: NWJ
Vert. Datum: ~	Station: ~	Drill Rig Equipment: B-61 Mobile Truck	Hammer Type: Automatic
Horiz. Datum: NAD83	Offset: ~	Other Comments:	

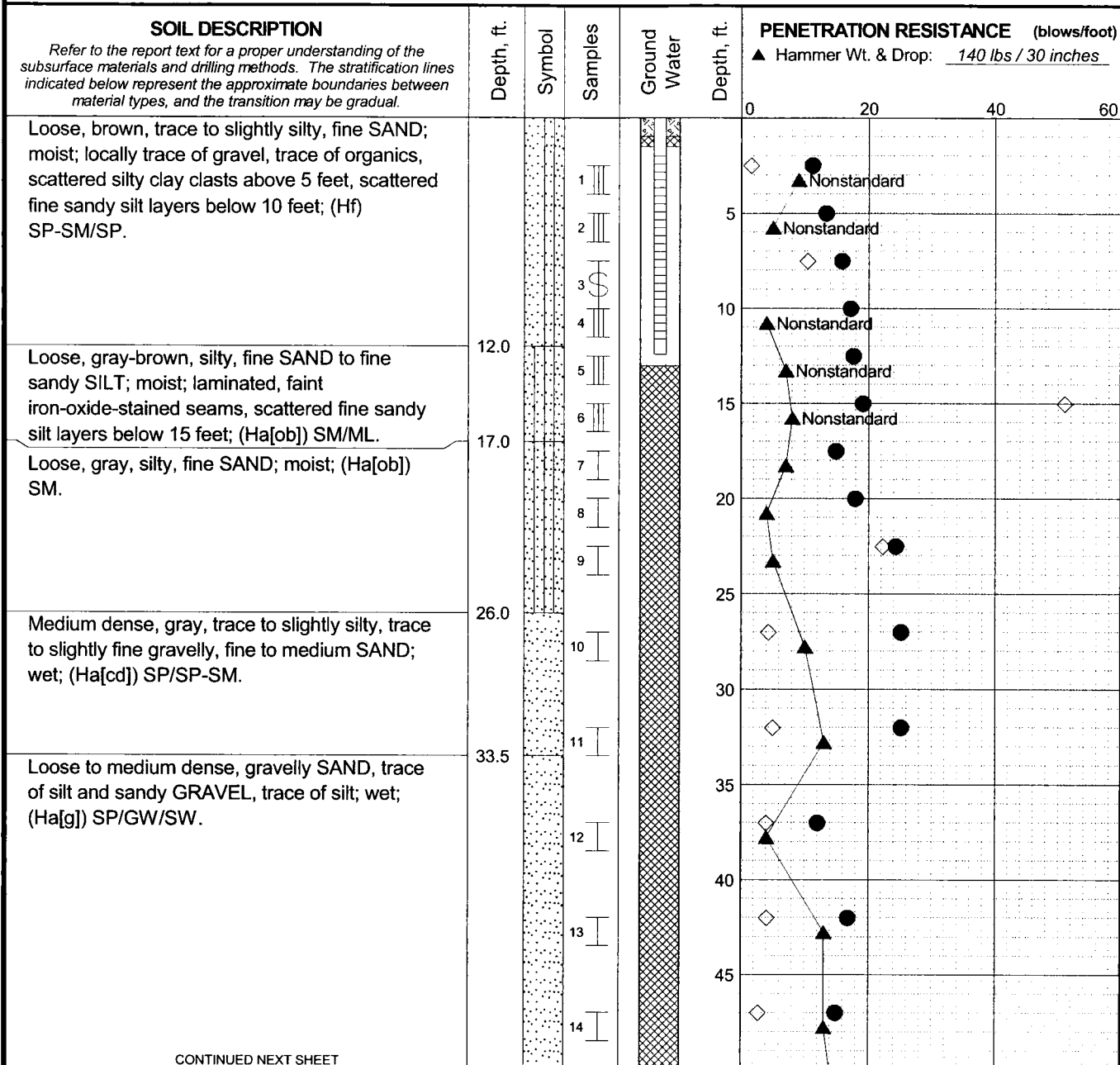

Log: EVP Rev: JKN Typ: CLP
MASTER LOG E 21-21199.GPJ SHAN WIL.GDT 6/1/10

CONTINUED NEXT SHEET

- LEGEND**
- | | | | | |
|------------------------|--|-----------------------------------|--|-----------------------|
| * Sample Not Recovered | | Piezometer Screen and Sand Filter | | Natural Water Content |
| | | Bentonite-Cement Grout | | Liquid Limit |
| | | Bentonite Chips/Pellets | | Plastic Limit |
| | | Bentonite Grout | | |

- NOTES**
- Refer to KEY for explanation of symbols, codes, abbreviations and definitions.
 - The stratification lines represent the approximate boundaries between soil types, and the transition may be gradual.
 - The discussion in the text of this report is necessary for a proper understanding of the nature of the subsurface materials.
 - Groundwater level, if indicated above, is for the date specified and may vary.
 - USCS designation is based on visual-manual classification and selected lab testing.

Skagit River Levee General Investigation
Skagit County, Washington

LOG OF BORING DD17-3 Levee

June 2010 21-1-21199-002

SHANNON & WILSON, INC. Geotechnical and Environmental Consultants	FIG. A-13 Sheet 1 of 2
---	----------------------------------

Total Depth: 66 ft.	Northing: ~ 525,290 ft.	Drilling Method: Mud Rotary	Hole Diam.: 5 in.
Top Elevation: ~	Easting: ~ 1,272,702 ft.	Drilling Company: Holocene Drilling	Rod Diam.: NWJ
Vert. Datum: ~	Station: ~	Drill Rig Equipment: B-61 Mobile Truck	Hammer Type: Automatic
Horiz. Datum: NAD83	Offset: ~	Other Comments:	

SOIL DESCRIPTION
Refer to the report text for a proper understanding of the subsurface materials and drilling methods. The stratification lines indicated below represent the approximate boundaries between material types, and the transition may be gradual.

Soft to medium stiff, gray, slightly clayey to clayey SILT, trace of fine sand and SILT; wet; trace to scattered organics; (Ha[ob]) ML.

BOTTOM OF BORING COMPLETED 10/14/2009

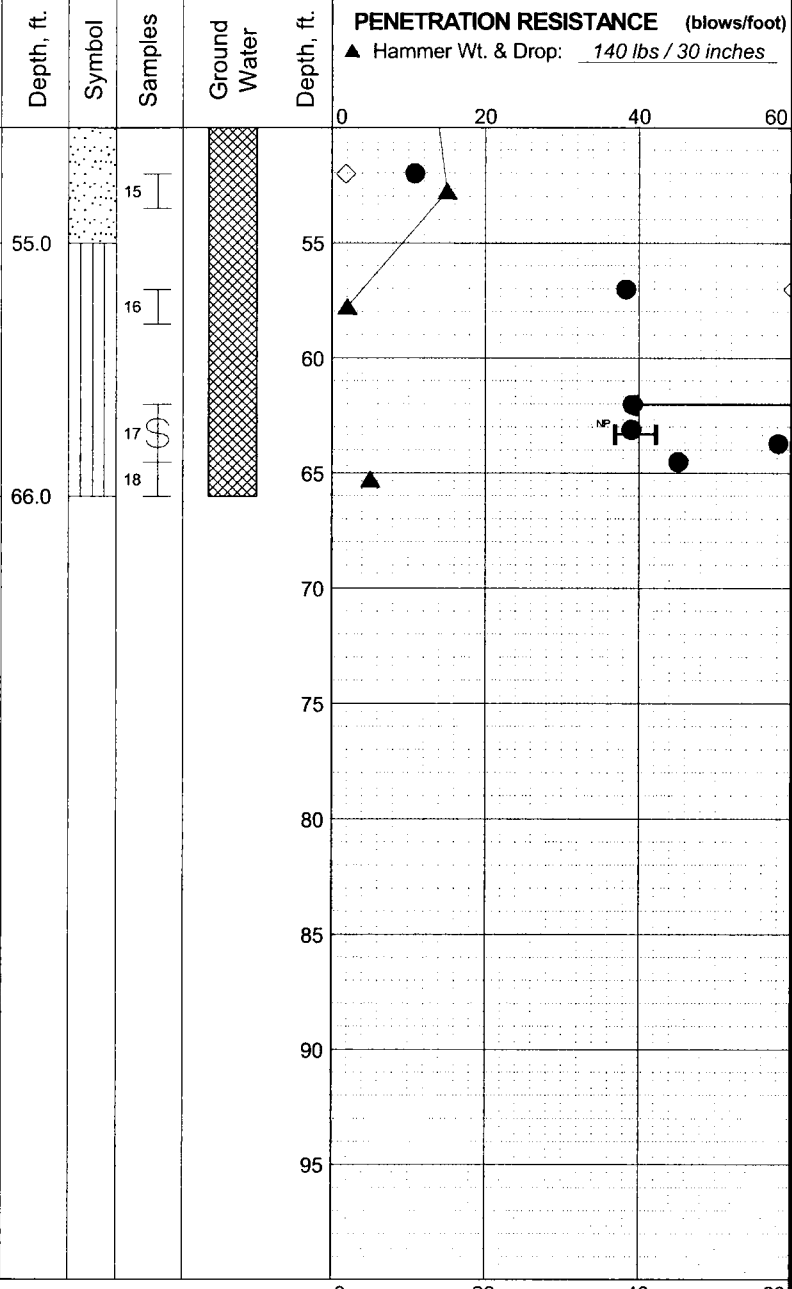

Log: EVP Rev: JKN Typ: CLP MASTER LOG E 21-21199.GPJ SHAN_WIL.GDT 6/1/10

- LEGEND**
- * Sample Not Recovered
 - Piezometer Screen and Sand Filter
 - ◇ % Fines (<0.075mm)
 - % Water Content
 - ▨ 3" O.D. Split Spoon Sample
 - ▨ Bentonite-Cement Grout
 - Plastic Limit
 - Liquid Limit
 - ▨ 3" O.D. Thin-Walled Tube
 - ▨ Bentonite Chips/Pellets
 - Natural Water Content
 - | Standard Penetration Test
 - ▨ Bentonite Grout

- NOTES**
- Refer to KEY for explanation of symbols, codes, abbreviations and definitions.
 - The stratification lines represent the approximate boundaries between soil types, and the transition may be gradual.
 - The discussion in the text of this report is necessary for a proper understanding of the nature of the subsurface materials.
 - Groundwater level, if indicated above, is for the date specified and may vary.
 - USCS designation is based on visual-manual classification and selected lab testing.

Skagit River Levee General Investigation
Skagit County, Washington

LOG OF BORING DD17-3 Levee

June 2010
21-21199-002

SHANNON & WILSON, INC.
Geotechnical and Environmental Consultants
FIG. A-13
Sheet 2 of 2

Total Depth: 41.5 ft.	Northing: ~ 504,871 ft.	Drilling Method: Mud Rotary	Hole Diam.: 5 in.
Top Elevation: ~	Easting: ~ 1,268,661 ft.	Drilling Company: Holocene Drilling	Rod Diam.: NWJ
Vert. Datum: ~	Station: ~	Drill Rig Equipment: BK-81 Truck	Hammer Type: Automatic
Horiz. Datum: NAD83	Offset: ~	Other Comments:	

SOIL DESCRIPTION
Refer to the report text for a proper understanding of the subsurface materials and drilling methods. The stratification lines indicated below represent the approximate boundaries between material types, and the transition may be gradual.

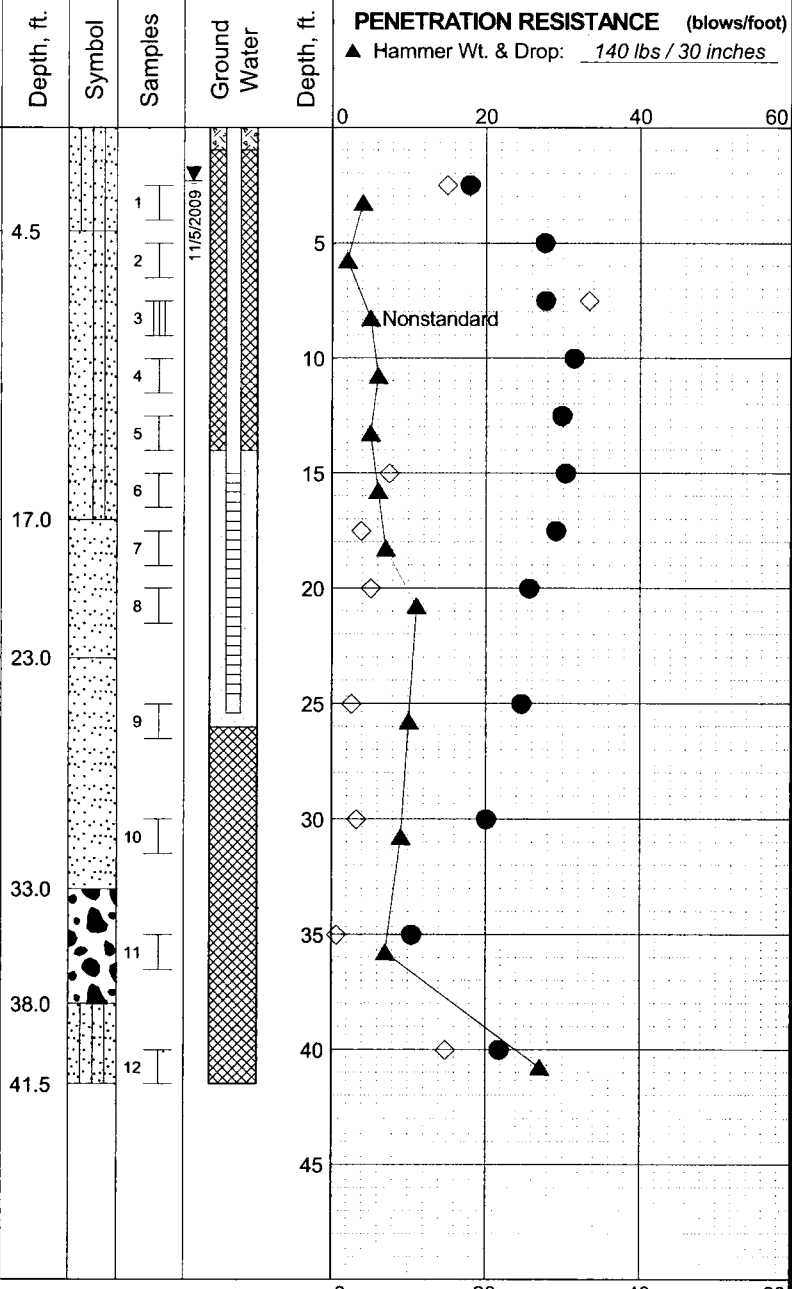

Loose, gray-brown, silty, fine SAND; moist; scattered roots; (Ha[ob]) SM.

Very loose to loose, gray, slightly silty to silty, fine to medium SAND; wet; trace of organics, moist above 7 feet; (Ha[cd]) SP-SM/SM.

Loose to medium dense, gray, trace to slightly silty, fine to medium SAND; wet; (Ha[cd]) SP/SP-SM.

Loose, gray, trace to slightly gravelly SAND, trace of silt; wet; (Ha[cd]) SP.

Loose, gray, sandy GRAVEL, trace of silt; wet; (Ha[g]) GW.

Medium dense, gray, silty, fine to medium SAND; wet; numerous shell fragments; (He) SM.

BOTTOM OF BORING
COMPLETED 10/21/2009

Log: EVP Rev: JKN Typ: LKN MASTER LOG E 21-21199.GPJ SHAN WIL GDT 6/1/10

- LEGEND**
- * Sample Not Recovered
 - I Standard Penetration Test
 - III 3" O.D. Split Spoon Sample
 - Piezometer Screen and Sand Filter
 - ▨ Bentonite-Cement Grout
 - ▩ Bentonite Chips/Pellets
 - ▧ Bentonite Grout
 - ▼ Ground Water Level in Well
 - ◇ % Fines (<0.075mm)
 - % Water Content

- NOTES**
1. Refer to KEY for explanation of symbols, codes, abbreviations and definitions.
 2. The stratification lines represent the approximate boundaries between soil types, and the transition may be gradual.
 3. The discussion in the text of this report is necessary for a proper understanding of the nature of the subsurface materials.
 4. Groundwater level, if indicated above, is for the date specified and may vary.
 5. USCS designation is based on visual-manual classification and selected lab testing.

Skagit River Levee General Investigation
Skagit County, Washington

LOG OF BORING DD22-1 Landward

June 2010 21-1-21199-002

SHANNON & WILSON, INC.
Geotechnical and Environmental Consultants

FIG. A-14

Total Depth: 61.5 ft.	Northing: ~ 504,876 ft.	Drilling Method: Mud Rotary	Hole Diam.: 5 in.
Top Elevation: ~	Easting: ~ 1,268,717 ft.	Drilling Company: Holocene Drilling	Rod Diam.: NWJ
Vert. Datum: ~	Station: ~	Drill Rig Equipment: BK-81 Truck	Hammer Type: Automatic
Horiz. Datum: NAD83	Offset: ~	Other Comments:	

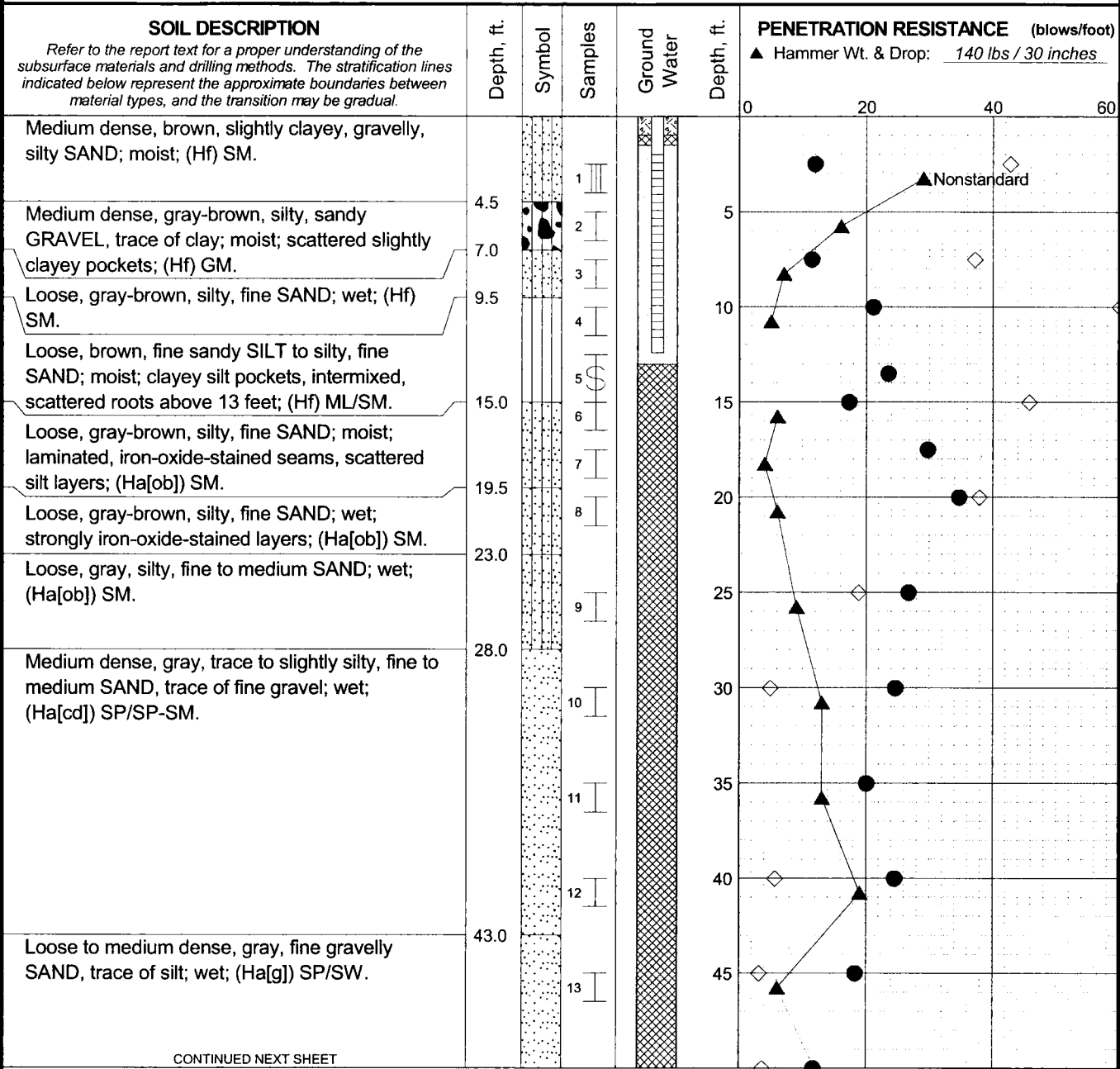

CONTINUED NEXT SHEET

- LEGEND**
- * Sample Not Recovered
 - Piezometer Screen and Sand Filter
 - ◇ % Fines (<0.075mm)
 - ▨ 3" O.D. Split Spoon Sample
 - ▩ Bentonite-Cement Grout
 - % Water Content
 - ⊥ Standard Penetration Test
 - ▨ Bentonite Chips/Pellets
 - ⊥ 3" O.D. Thin-Walled Tube
 - ▨ Bentonite Grout

- NOTES**
- Refer to KEY for explanation of symbols, codes, abbreviations and definitions.
 - The stratification lines represent the approximate boundaries between soil types, and the transition may be gradual.
 - The discussion in the text of this report is necessary for a proper understanding of the nature of the subsurface materials.
 - Groundwater level, if indicated above, is for the date specified and may vary.
 - USCS designation is based on visual-manual classification and selected lab testing.

Skagit River Levee General Investigation
Skagit County, Washington

LOG OF BORING DD22-1 Levee

June 2010 21-1-21199-002

SHANNON & WILSON, INC.
Geotechnical and Environmental Consultants

FIG. A-15
Sheet 1 of 2

Log: EVP Rev: JKN Typ: LKN MASTER LOG E 21-21199.GPJ SHAN WIL GDT 6/1/10

Total Depth: <u>61.5 ft.</u>	Northing: <u>~ 504,876 ft.</u>	Drilling Method: <u>Mud Rotary</u>	Hole Diam.: <u>5 in.</u>
Top Elevation: <u>~</u>	Easting: <u>~ 1,268,717 ft.</u>	Drilling Company: <u>Holocene Drilling</u>	Rod Diam.: <u>NWJ</u>
Vert. Datum: <u>~</u>	Station: <u>~</u>	Drill Rig Equipment: <u>BK-81 Truck</u>	Hammer Type: <u>Automatic</u>
Horiz. Datum: <u>NAD83</u>	Offset: <u>~</u>	Other Comments: <u>~</u>	

SOIL DESCRIPTION
Refer to the report text for a proper understanding of the subsurface materials and drilling methods. The stratification lines indicated below represent the approximate boundaries between material types, and the transition may be gradual.

Medium dense, gray, silty, fine to medium SAND, trace of clay; wet; scattered shell fragments; (He) SM.

Medium dense, gray, slightly silty, fine to medium SAND; wet; trace of shell fragments; (He) SP-SM.

BOTTOM OF BORING COMPLETED 10/22/2009

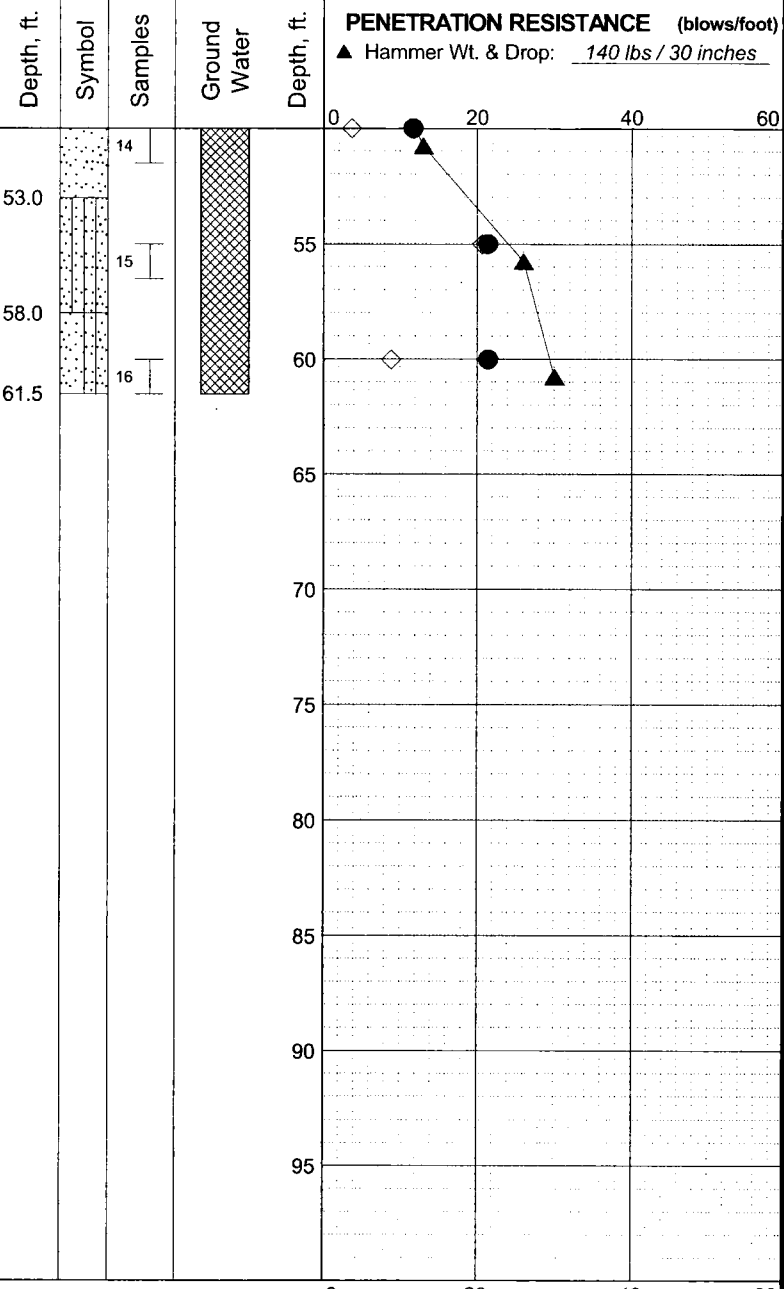

Log: EVP Rev: JKN Typ: LKN MASTER LOG E 21-21199.GPJ SHAN_WIL.GDT 6/1/10

LEGEND

- * Sample Not Recovered
- III 3" O.D. Split Spoon Sample
- Standard Penetration Test
- 3" O.D. Thin-Walled Tube
- Piezometer Screen and Sand Filter
- Bentonite-Cement Grout
- Bentonite Chips/Pellets
- Bentonite Grout
- ◇ % Fines (<0.075mm)
- % Water Content

NOTES

1. Refer to KEY for explanation of symbols, codes, abbreviations and definitions.
2. The stratification lines represent the approximate boundaries between soil types, and the transition may be gradual.
3. The discussion in the text of this report is necessary for a proper understanding of the nature of the subsurface materials.
4. Groundwater level, if indicated above, is for the date specified and may vary.
5. USCS designation is based on visual-manual classification and selected lab testing.

Skagit River Levee General Investigation
Skagit County, Washington

LOG OF BORING DD22-1 Levee

June 2010 21-21199-002

SHANNON & WILSON, INC. Geotechnical and Environmental Consultants	FIG. A-15 Sheet 2 of 2
---	----------------------------------

Total Depth: 42.5 ft.	Northing: ~ 502,793 ft.	Drilling Method: Mud Rotary	Hole Diam.: 5 in.
Top Elevation: ~	Easting: ~ 1,259,501 ft.	Drilling Company: Holocene Drilling	Rod Diam.: NWJ
Vert. Datum: ~	Station: ~	Drill Rig Equipment: BK-81 Truck	Hammer Type: Automatic
Horiz. Datum: NAD83	Offset: ~	Other Comments:	

SOIL DESCRIPTION
Refer to the report text for a proper understanding of the subsurface materials and drilling methods. The stratification lines indicated below represent the approximate boundaries between material types, and the transition may be gradual.

Very loose, gray and brown, slightly fine sandy to fine sandy SILT, trace of clay to soft, slightly clayey SILT; wet; scattered iron-oxide-stained seams, peat seam at 5.9 feet, numerous wood fragments and coarse organics below 6 feet, laminated; (Ha[ob]) ML.

Very loose, gray, silty, fine SAND; wet; laminated, scattered organics; (Ha[ob]) SM.

Loose to medium dense, gray, fine to medium SAND, trace of silt and fine gravel; wet; trace of organics; (Ha[cd]) SP.

Loose, gray, silty, fine SAND to fine sandy SILT; wet; scattered fine organics, laminated, scattered slightly clayey to clayey seams, slightly silty, fine sand below 41.5 feet; (Ha[ob]) SM/ML.

BOTTOM OF BORING COMPLETED 10/22/2009

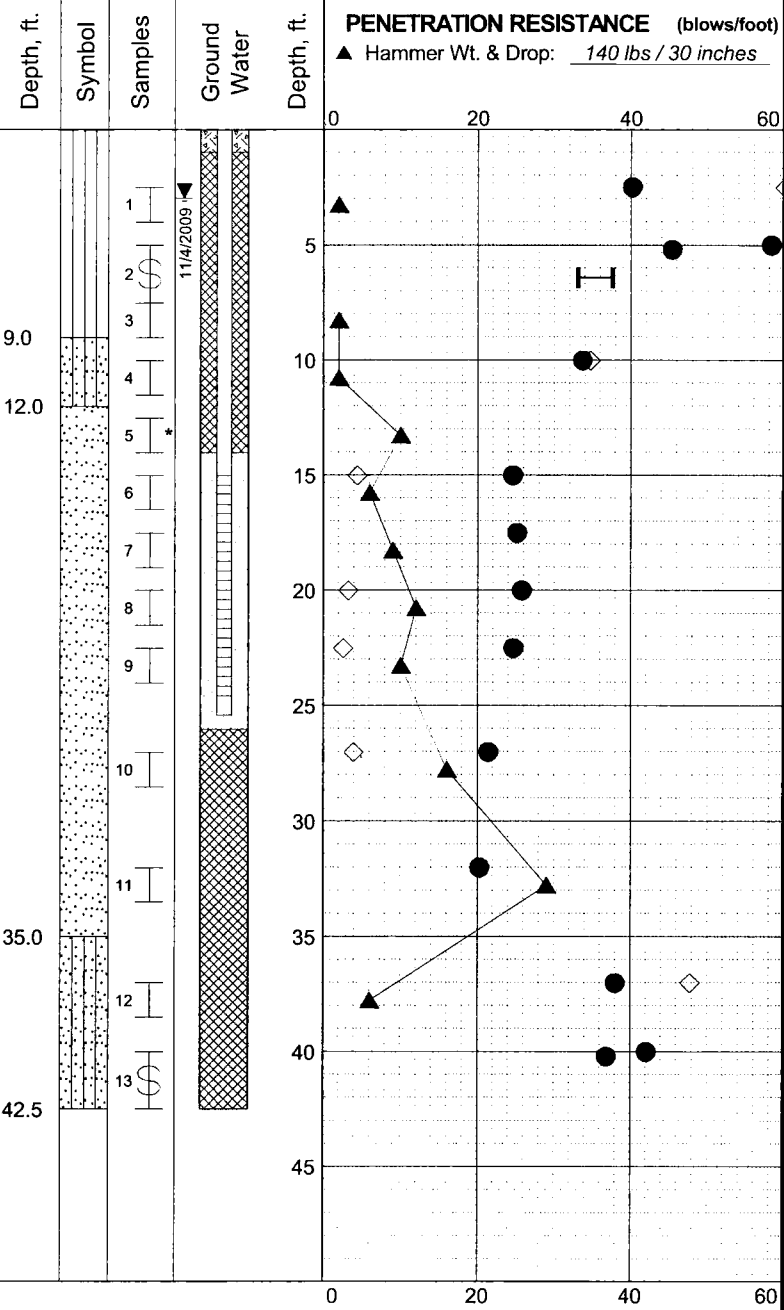

Log: E/P Rev: JKN Typ: LKN MASTER LOG E 21-21199.GPJ SHAN_WIL_GDT 6/1/10

- LEGEND**
- * Sample Not Recovered
 - Standard Penetration Test
 - 3" O.D. Thin-Walled Tube
 - Piezometer Screen and Sand Filter
 - Bentonite-Cement Grout
 - Bentonite Chips/Pellets
 - Bentonite Grout
 - Ground Water Level in Well
 - ◇ % Fines (<0.075mm)
 - % Water Content
 - Plastic Limit
 - Liquid Limit
 - Natural Water Content

- NOTES**
- Refer to KEY for explanation of symbols, codes, abbreviations and definitions.
 - The stratification lines represent the approximate boundaries between soil types, and the transition may be gradual.
 - The discussion in the text of this report is necessary for a proper understanding of the nature of the subsurface materials.
 - Groundwater level, if indicated above, is for the date specified and may vary.
 - USCS designation is based on visual-manual classification and selected lab testing.

Skagit River Levee General Investigation
Skagit County, Washington

LOG OF BORING DD22-2 Landward

June 2010 21-21199-002

SHANNON & WILSON, INC.
Geotechnical and Environmental Consultants

FIG. A-16

Total Depth: 61.5 ft.	Northing: ~ 502,860 ft.	Drilling Method: Mud Rotary	Hole Diam.: 5 in.
Top Elevation: ~	Easting: ~ 1,259,493 ft.	Drilling Company: Holocene Drilling	Rod Diam.: NWJ
Vert. Datum: ~	Station: ~	Drill Rig Equipment: BK-81 Truck	Hammer Type: Automatic
Horiz. Datum: NAD83	Offset: ~	Other Comments:	

SOIL DESCRIPTION
Refer to the report text for a proper understanding of the subsurface materials and drilling methods. The stratification lines indicated below represent the approximate boundaries between material types, and the transition may be gradual.

Stiff, brown and gray, slightly fine gravelly, sandy, silty CLAY; moist; trace of iron-oxide-stained pockets, scattered clayey sand pockets, trace of roots; (Hf) CL.	4.5
Medium dense, brown, fine gravelly, silty SAND; moist; intermixed, locally trace of clay, trace of iron-oxide stains; (Hf) SM.	7.0
Loose to medium dense, brown, silty, fine SAND; moist; fine sandy silt layers below 12 feet, locally trace of gravel; (Hf) SM.	14.5
Soft, brown, slightly fine sandy SILT; wet; trace of organics, scattered silty, fine sand seams and layers, trace of iron-oxide staining; (Ha[ob]) ML.	18.5
Medium stiff, gray, clayey SILT, trace of fine sand; wet; trace of organics, laminated, iron-oxide-stained seams, scattered dark brown, organic-rich partings, scattered slightly fine sandy silt seams; (Ha[ob]) ML.	23.0
Very loose to loose, gray, slightly silty to silty, fine to medium SAND; wet; numerous organics, scattered wood fragments; (Ha[cd]) SM/SP-SM.	33.0
Medium dense, gray, slightly silty SAND, trace of fine gravel; wet; (Ha[cd]) SP-SM.	48.0
- Scattered large wood fragments and silty clay seams at 45 feet.	

PENETRATION RESISTANCE (blows/foot)
▲ Hammer Wt. & Drop: 140 lbs / 30 inches

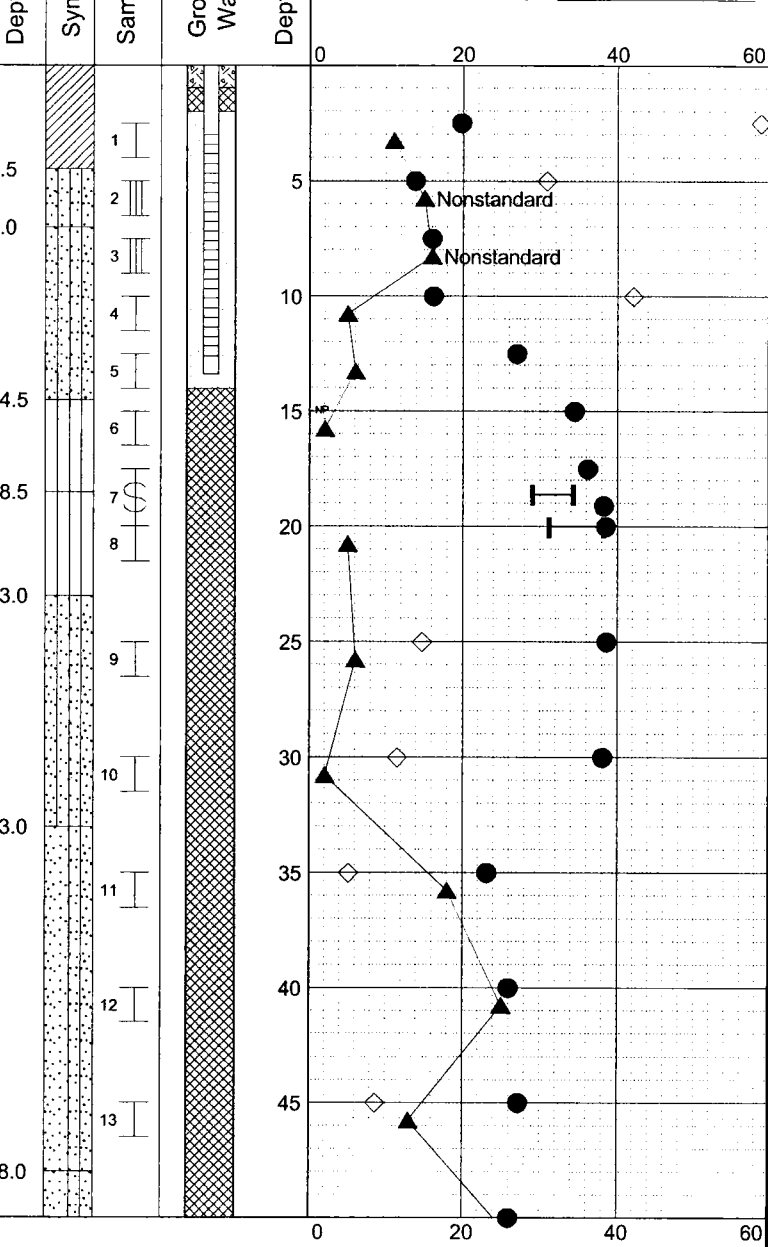

Log: EVP Rev: JKN Typ: LKN MASTER LOG E 21-21199.GPJ SHAN_WIL_GDT 6/1/10

CONTINUED NEXT SHEET

- LEGEND**
- * Sample Not Recovered
 - Piezometer Screen and Sand Filter
 - ◇ % Fines (<0.075mm)
 - I Standard Penetration Test
 - ▨ Bentonite-Cement Grout
 - % Water Content
 - III 3" O.D. Split Spoon Sample
 - ▩ Bentonite Chips/Pellets
 - Plastic Limit
 - S 3" O.D. Thin-Walled Tube
 - ▧ Bentonite Grout
 - Liquid Limit
 - Natural Water Content

- NOTES**
- Refer to KEY for explanation of symbols, codes, abbreviations and definitions.
 - The stratification lines represent the approximate boundaries between soil types, and the transition may be gradual.
 - The discussion in the text of this report is necessary for a proper understanding of the nature of the subsurface materials.
 - Groundwater level, if indicated above, is for the date specified and may vary.
 - USCS designation is based on visual-manual classification and selected lab testing.

Skagit River Levee General Investigation
Skagit County, Washington

LOG OF BORING DD22-2 Levee

June 2010
21-1-21199-002

SHANNON & WILSON, INC.
Geotechnical and Environmental Consultants
FIG. A-17
Sheet 1 of 2

Total Depth: 61.5 ft.	Northing: ~ 502,860 ft.	Drilling Method: Mud Rotary	Hole Diam.: 5 in.
Top Elevation: ~	Easting: ~ 1,259,493 ft.	Drilling Company: Holocene Drilling	Rod Diam.: NWJ
Vert. Datum: ~	Station: ~	Drill Rig Equipment: BK-81 Truck	Hammer Type: Automatic
Horiz. Datum: NAD83	Offset: ~	Other Comments: ~	

SOIL DESCRIPTION
Refer to the report text for a proper understanding of the subsurface materials and drilling methods. The stratification lines indicated below represent the approximate boundaries between material types, and the transition may be gradual.

Medium dense, gray, trace to slightly silty, fine to medium SAND; wet; (Ha[cd]) SP-SM/SP.

- Trace of wood fragments at 60 feet.

BOTTOM OF BORING COMPLETED 10/23/2009

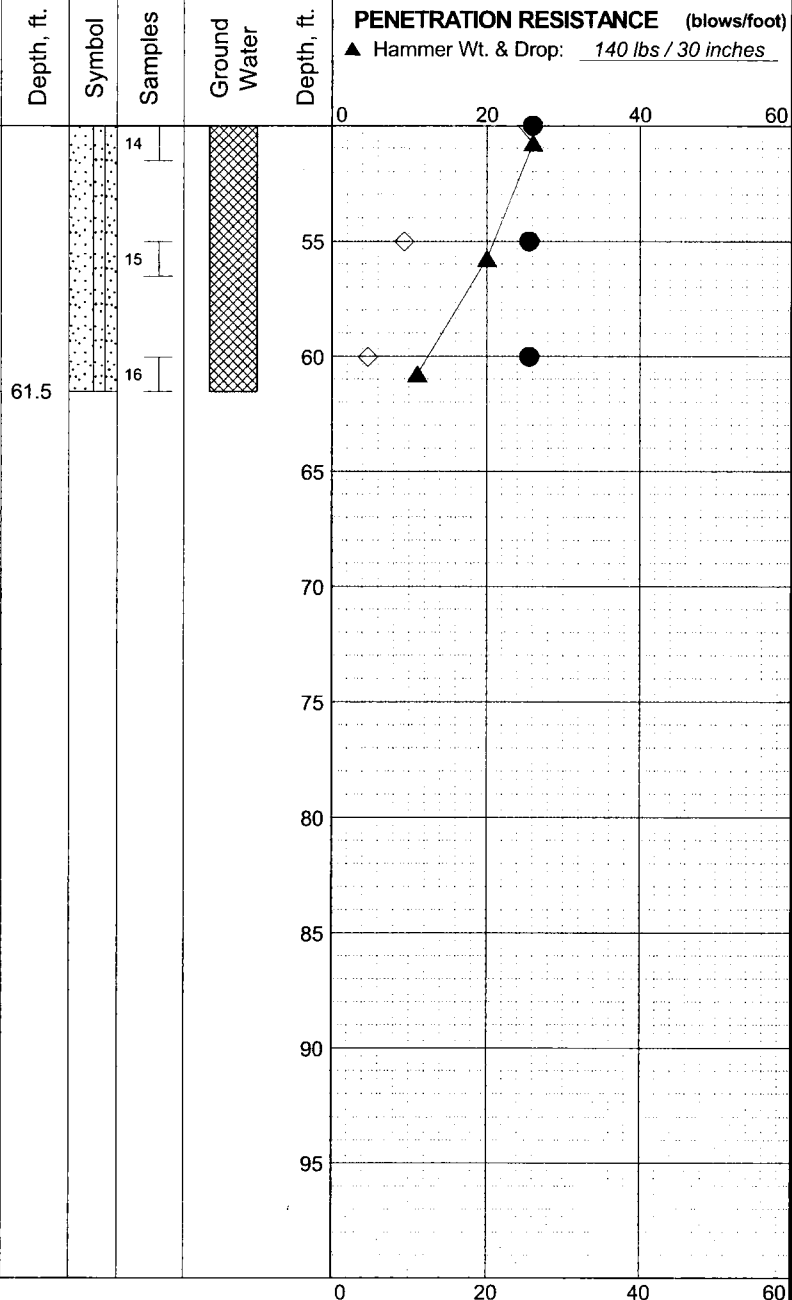

Log: EVP Rev: JKN Typ: LKN MASTER LOG: E 21-21199.GPJ SHAN WIL.GDT 6/1/10

- LEGEND**
- * Sample Not Recovered
 - Piezometer Screen and Sand Filter
 - ◇ % Fines (<0.075mm)
 - % Water Content
 - | Standard Penetration Test
 - ▨ Bentonite-Cement Grout
 - Plastic Limit
 - Liquid Limit
 - ▨ 3" O.D. Split Spoon Sample
 - ▨ Bentonite Chips/Pellets
 - Natural Water Content
 - ▨ 3" O.D. Thin-Walled Tube
 - ▨ Bentonite Grout

- NOTES**
- Refer to KEY for explanation of symbols, codes, abbreviations and definitions.
 - The stratification lines represent the approximate boundaries between soil types, and the transition may be gradual.
 - The discussion in the text of this report is necessary for a proper understanding of the nature of the subsurface materials.
 - Groundwater level, if indicated above, is for the date specified and may vary.
 - USCS designation is based on visual-manual classification and selected lab testing.

Skagit River Levee General Investigation
Skagit County, Washington

LOG OF BORING DD22-2 Levee

June 2010
21-21199-002

SHANNON & WILSON, INC.
Geotechnical and Environmental Consultants
FIG. A-17
Sheet 2 of 2

APPENDIX B
SAMPLE SEEP/W AND SLOPE/W ANALYSES

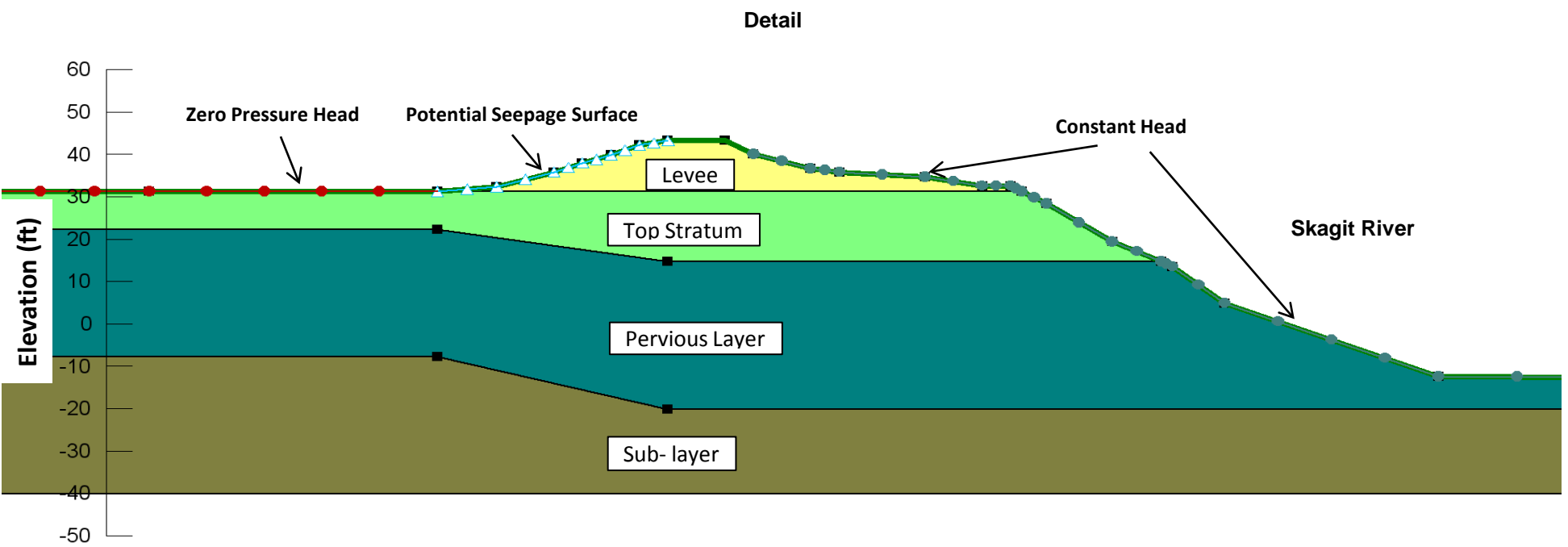
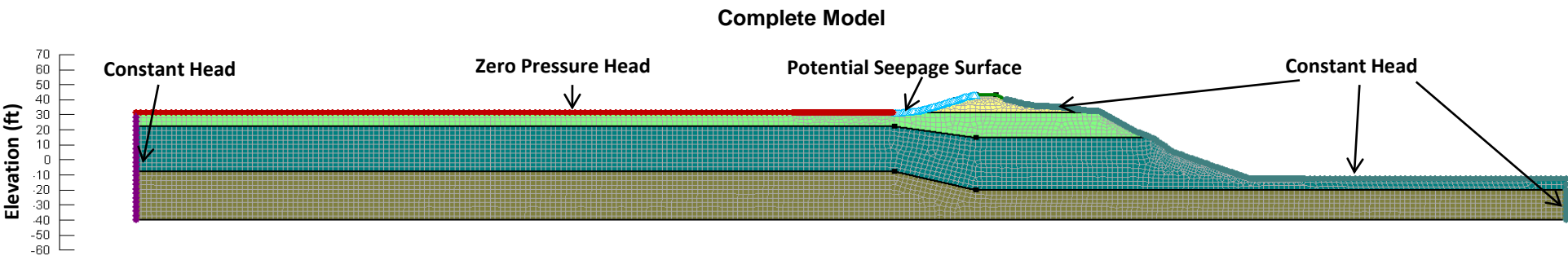

Notes:
1. Horizontal equals vertical.

FIG. B-1

Skagit River Levee General Investigation Levee Risk and Reliability Analysis Skagit County, Washington	
DD17-1 CROSS SECTION SEEPAGE ANALYSIS BOUNDARY CONDITIONS	
January 2011	21-1-21199-003
SHANNON & WILSON, INC. Geotechnical and Environmental Consultants	FIG. B-1

Complete Model

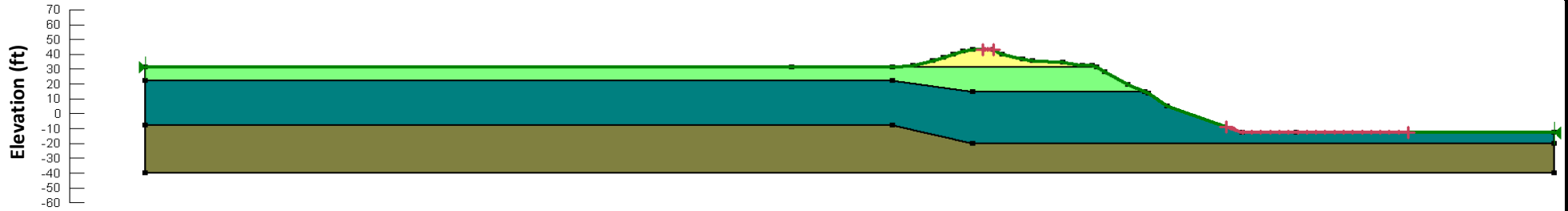

Detail

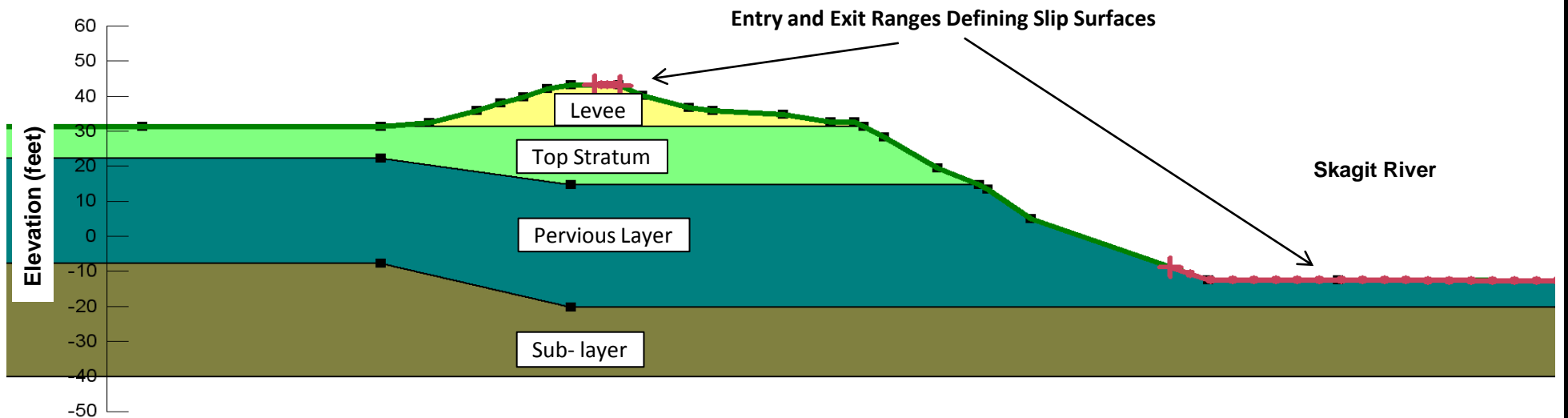

Notes:

1. Horizontal equals vertical.

FIG. B-2

Skagit River Levee General Investigation
 Levee Risk and Reliability Analysis
 Skagit County, Washington

**DD17-1 CROSS SECTION
 LIMIT EQUILIBRIUM ANALYSIS
 GEOMETRY AND SEARCH CRITERIA**

January 2011

21-1-21199-003

SHANNON & WILSON, INC.
 Geotechnical and Environmental Consultants

FIG. B-2

APPENDIX C

**IMPORTANT INFORMATION ABOUT YOUR
GEOTECHNICAL/ENVIRONMENTAL REPORT**



Date: January 31, 2011
To: Mr. Daniel E. Johnson
U.S. Army Corps of Engineers,
Seattle District

IMPORTANT INFORMATION ABOUT YOUR GEOTECHNICAL/ENVIRONMENTAL REPORT

CONSULTING SERVICES ARE PERFORMED FOR SPECIFIC PURPOSES AND FOR SPECIFIC CLIENTS.

Consultants prepare reports to meet the specific needs of specific individuals. A report prepared for a civil engineer may not be adequate for a construction contractor or even another civil engineer. Unless indicated otherwise, your consultant prepared your report expressly for you and expressly for the purposes you indicated. No one other than you should apply this report for its intended purpose without first conferring with the consultant. No party should apply this report for any purpose other than that originally contemplated without first conferring with the consultant.

THE CONSULTANT'S REPORT IS BASED ON PROJECT-SPECIFIC FACTORS.

A geotechnical/environmental report is based on a subsurface exploration plan designed to consider a unique set of project-specific factors. Depending on the project, these may include: the general nature of the structure and property involved; its size and configuration; its historical use and practice; the location of the structure on the site and its orientation; other improvements such as access roads, parking lots, and underground utilities; and the additional risk created by scope-of-service limitations imposed by the client. To help avoid costly problems, ask the consultant to evaluate how any factors that change subsequent to the date of the report may affect the recommendations. Unless your consultant indicates otherwise, your report should not be used: (1) when the nature of the proposed project is changed (for example, if an office building will be erected instead of a parking garage, or if a refrigerated warehouse will be built instead of an unrefrigerated one, or chemicals are discovered on or near the site); (2) when the size, elevation, or configuration of the proposed project is altered; (3) when the location or orientation of the proposed project is modified; (4) when there is a change of ownership; or (5) for application to an adjacent site. Consultants cannot accept responsibility for problems that may occur if they are not consulted after factors which were considered in the development of the report have changed.

SUBSURFACE CONDITIONS CAN CHANGE.

Subsurface conditions may be affected as a result of natural processes or human activity. Because a geotechnical/environmental report is based on conditions that existed at the time of subsurface exploration, construction decisions should not be based on a report whose adequacy may have been affected by time. Ask the consultant to advise if additional tests are desirable before construction starts; for example, groundwater conditions commonly vary seasonally.

Construction operations at or adjacent to the site and natural events such as floods, earthquakes, or groundwater fluctuations may also affect subsurface conditions and, thus, the continuing adequacy of a geotechnical/environmental report. The consultant should be kept apprised of any such events, and should be consulted to determine if additional tests are necessary.

MOST RECOMMENDATIONS ARE PROFESSIONAL JUDGMENTS.

Site exploration and testing identifies actual surface and subsurface conditions only at those points where samples are taken. The data were extrapolated by your consultant, who then applied judgment to render an opinion about overall subsurface conditions. The actual interface between materials may be far more gradual or abrupt than your report indicates. Actual conditions in areas not sampled may differ from those predicted in your report. While nothing can be done to prevent such situations, you and your consultant can work together to help reduce their impacts. Retaining your consultant to observe subsurface construction operations can be particularly beneficial in this respect.

A REPORT'S CONCLUSIONS ARE PRELIMINARY.

The conclusions contained in your consultant's report are preliminary because they must be based on the assumption that conditions revealed through selective exploratory sampling are indicative of actual conditions throughout a site. Actual subsurface conditions can be discerned only during earthwork; therefore, you should retain your consultant to observe actual conditions and to provide conclusions. Only the consultant who prepared the report is fully familiar with the background information needed to determine whether or not the report's recommendations based on those conclusions are valid and whether or not the contractor is abiding by applicable recommendations. The consultant who developed your report cannot assume responsibility or liability for the adequacy of the report's recommendations if another party is retained to observe construction.

THE CONSULTANT'S REPORT IS SUBJECT TO MISINTERPRETATION.

Costly problems can occur when other design professionals develop their plans based on misinterpretation of a geotechnical/environmental report. To help avoid these problems, the consultant should be retained to work with other project design professionals to explain relevant geotechnical, geological, hydrogeological, and environmental findings, and to review the adequacy of their plans and specifications relative to these issues.

BORING LOGS AND/OR MONITORING WELL DATA SHOULD NOT BE SEPARATED FROM THE REPORT.

Final boring logs developed by the consultant are based upon interpretation of field logs (assembled by site personnel), field test results, and laboratory and/or office evaluation of field samples and data. Only final boring logs and data are customarily included in geotechnical/environmental reports. These final logs should not, under any circumstances, be redrawn for inclusion in architectural or other design drawings, because drafters may commit errors or omissions in the transfer process.

To reduce the likelihood of boring log or monitoring well misinterpretation, contractors should be given ready access to the complete geotechnical engineering/environmental report prepared or authorized for their use. If access is provided only to the report prepared for you, you should advise contractors of the report's limitations, assuming that a contractor was not one of the specific persons for whom the report was prepared, and that developing construction cost estimates was not one of the specific purposes for which it was prepared. While a contractor may gain important knowledge from a report prepared for another party, the contractor should discuss the report with your consultant and perform the additional or alternative work believed necessary to obtain the data specifically appropriate for construction cost estimating purposes. Some clients hold the mistaken impression that simply disclaiming responsibility for the accuracy of subsurface information always insulates them from attendant liability. Providing the best available information to contractors helps prevent costly construction problems and the adversarial attitudes that aggravate them to a disproportionate scale.

READ RESPONSIBILITY CLAUSES CLOSELY.

Because geotechnical/environmental engineering is based extensively on judgment and opinion, it is far less exact than other design disciplines. This situation has resulted in wholly unwarranted claims being lodged against consultants. To help prevent this problem, consultants have developed a number of clauses for use in their contracts, reports and other documents. These responsibility clauses are not exculpatory clauses designed to transfer the consultant's liabilities to other parties; rather, they are definitive clauses that identify where the consultant's responsibilities begin and end. Their use helps all parties involved recognize their individual responsibilities and take appropriate action. Some of these definitive clauses are likely to appear in your report, and you are encouraged to read them closely. Your consultant will be pleased to give full and frank answers to your questions.

The preceding paragraphs are based on information provided by the
ASFE/Association of Engineering Firms Practicing in the Geosciences, Silver Spring, Maryland